

up

Universitatea  
Politehnica  
Timișoara

# Research Report 2013

**Research  
Annual  
Report**

Politehnica  
University  
of Timisoara  
2013

# Research Report 2013

Research Report, 2013

Copyright © Editura Politehnica 2014

All rights reserved to Politehnica University of Timisoara.

No part of this booklet may be reproduced or transmitted in any form or by any means, electronic or mechanical, including photocopy, recording, or any information storage and retrieval system now known or to be invented, without permission in writing from the publisher, except by a reviewer who wishes to quote brief passages in connection with a review written for inclusion in a magazine, newspaper, or broadcast.

Editor:  
Prof. Marius OTEȘTEANU, PhD

Co-Editors:  
Iris MIHAI  
Adina PALEA, PhD

Layout & cover design:  
IDEAtm  
Eugen STAN

Editura Politehnica  
Bv. Republicii, nr. 9, 300159  
Timișoara, România  
Phone: +40 256 403823  
Fax: +40 256 403021

ISSN 1841-2769

Research  
Report 2013

**Research  
Annual  
Report**  
Politehnica  
University  
of Timisoara  
2013





# Structure of the report

Introducing the Report.....	5
Research Centers.....	9
Projects supported by public funds.....	15
Successful Project.....	19
Research Projects.....	27
Research Adjacent Projects.....	105
Projects supported by private funds.....	125
Patents.....	143
Granted Patents.....	145
Patents Requests.....	147
Utility Models.....	157
Doctor Honoris Causa.....	165
Habilitation Theses.....	169
PhD Theses.....	173
Scientific conferences and events.....	181
Scientific Journals.....	185
ISI Papers.....	189
ISI Publications.....	189
ISI Proceedings.....	203
Books.....	211



# Introducing the Report



Politehnica University of Timisoara (UPT) is more than a simple teaching institution, it stands as a bastion of knowledge, a university of advanced research and education, which undertakes with devotion its goal to fulfill the requirements for competences of the societal environment by ensuring superior professional training for students and graduates.

The present document gathers the main results obtained through the research activities carried out within the university in 2013, Politehnica being renowned as a remarkable actor on the stage of scientific research, both at national and international level. Our research activity is facilitated by the existence of twenty-five research centres specialized in fields that are capital for the sustainable development of any modern society. Each of these research centres brings together various prestigious researchers, whom, by their effort and vision, provide UPT with the incentives needed to contribute to the progress of our society.

Most of the research activity carried out by our institution is financed through external sources, obtained either from national and international calls for projects, or through agreements with private companies. This represents a confirmation of the superior quality of the research, but also of the prestige and professional deontology of the researchers affiliated to our institution. Politehnica's reputation as an institution of advanced research is emphasized also by the patents obtained by its researchers, by the medals and prizes obtained in both national and international competitions, and by the collaborations with important research centres and institutes from Romania and from abroad.

Each year, we select the most talented young researchers for our doctoral school, providing them with the opportunity to transform their knowledge and ideas into the innovations of tomorrow. Many of them take part in peer learning programs consolidating the relationship between our university and similar partner institutions. They strive for becoming doctors in science and for making the world a better place.

This report is divided into eleven sections, each one presenting a specific component of the research activity performed within the institution. Therefore, we will start by presenting the research infrastructure, comprising the twenty-five research centres hosted by the university. The order in which they are presented is given by the research fields.

The second and third sections include the research projects implemented by the university. The second section includes the projects supported by public funds, both national and international, while the third one includes the projects supported by private funds awarded by companies. For the purposes of this report, we have chosen the most relevant projects for our research capacity, encompassing 53 publicly funded projects and 11 privately funded ones. Within each section, the projects are arranged by research fields.

In 2013 our institution was awarded two patents, having also submitted applications for another twelve. All these will be presented in the fourth section.

The fifth section presents three of our honorary members, that have been awarded the Professor Honoris Causa recognition for their contribution to the development of UPT and continuous support.

Section six and seven include habilitation theses and PhD theses. In 2013, two of our colleagues became habilitated, while 74 of our PhD research students became doctors.

Section eight presents an overview of the most relevant scientific conferences and events that brought together professionals from Romania and from abroad, hosting and encouraging the dialogue, exchange of ideas and the opportunity for new collaborations.

# Research Report 2013

---

The ninth section gathers the scientific journals that have been edited by our institution. This category includes 11 journals specialized in various fields like computer science, chemistry and environmental engineering, electronics and communications, economics and social sciences, electrical engineering, hydrotechnics, physical education and sport, modern languages etc.

The tenth section includes a bibliographic list of the ISI papers that have been published in 2013, comprising the results obtained by our researchers in several fields, papers that obtained recognition from some of the most prestigious journals, both from Romania and from abroad.

And, finally, the eleventh section comprises a collection of 41 books, most of them published under Politehnica Publishing House, but not limited to it.

Through research we generate ideas, through ideas we generate innovation and through innovation we contribute to the improvement of the quality of life; this is why research is our priority.

# Research Centres







### Research Centre for Computers and Information Technology

Director: prof. Crețu Vladimir-Ioan

Contact: [vladimir.cretu@upt.ro](mailto:vladimir.cretu@upt.ro), <http://www.cs.upt.ro/~vcretu>

Research projects under implementation can be found at pages: 27-29;



### Research Centre for Automatic Systems Engineering

Director: prof. Precup Radu-Emil

Contact: [radu.precup@upt.ro](mailto:radu.precup@upt.ro), <http://www.aut.upt.ro/centru-cercetare>

Research projects under implementation can be found at pages: 30-36; 107-108;

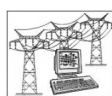

### Research Centre for Power Systems Analysis and Optimization

Director: prof. Kilyeni Ștefan

Contact: [stefan.kilyeni@upt.ro](mailto:stefan.kilyeni@upt.ro)

Research projects under implementation can be found at pages: 129-134;



### Research Centre for Smart Energy Conversion and Storage

Director: prof. Muntean Nicolae

Contact: [nicolae.muntean@upt.ro](mailto:nicolae.muntean@upt.ro)

Research projects under implementation can be found at pages: 135-136;



### Research Centre for Intelligent Electronic Systems

Director: prof. Oteșteanu Marius

Contact: [marius.otesteanu@upt.ro](mailto:marius.otesteanu@upt.ro), <http://www.ccesi.etc.upt.ro/index.php/ro>

Research projects under implementation can be found at pages: 37-38;



### Research Centre for Intelligent Signal Processing

Director: prof. Isar Alexandu

Contact: [alexandru.isar@upt.ro](mailto:alexandru.isar@upt.ro), <http://www.tc.etc.upt.ro/isprc>



### Research Centre for Multimedia

Director: prof. VasIU Radu

Contact: [radu.vasiu@upt.ro](mailto:radu.vasiu@upt.ro), <http://www.cm.upt.ro>

Research projects under implementation can be found at pages: 39-40; 103-104; 109-116; 121-124;



### Research Centre for Environmental Science and Engineering

Director: prof. Pode Rodica

Contact: [rodica.pode@upt.ro](mailto:rodica.pode@upt.ro), [http://www.chim.upt.ro/Facultatea-de-Chimie-Industrial-a-si-Ingineria-Mediului-Centru\\_GF.html](http://www.chim.upt.ro/Facultatea-de-Chimie-Industrial-a-si-Ingineria-Mediului-Centru_GF.html)

Research projects under implementation can be found at pages: 41-53; 139-140;



## Research Centre for Inorganic Materials and Alternative Energies

Director: prof. Lazău Ioan

Contact: [ioan.lazau@upt.ro](mailto:ioan.lazau@upt.ro), [http://www.chim.upt.ro/Facultatea-de-Chimie-Industriala-si-Ingineria-Mediului-Centru\\_Zx.html](http://www.chim.upt.ro/Facultatea-de-Chimie-Industriala-si-Ingineria-Mediului-Centru_Zx.html)

Research projects under implementation can be found at pages: 55-56;



## Research Centre for Organic, Macromolecular and Natural Compounds' Chemistry and Engineering

Director: prof. Davidescu Corneliu

Contact: [corneliu.davidescu@upt.ro](mailto:corneliu.davidescu@upt.ro), [http://www.chim.upt.ro/Facultatea-de-Chimie-Industriala-si-Ingineria-Mediului-Centru\\_VT.html](http://www.chim.upt.ro/Facultatea-de-Chimie-Industriala-si-Ingineria-Mediului-Centru_VT.html)



## Research Centre for Mechanics of Materials and Structural Safety

Director: prof. Dubină Dan

Contact: [dan.dubina@upt.ro](mailto:dan.dubina@upt.ro)

Research projects under implementation can be found at pages: 19-25; 57-64;



## Research Centre for Hidrotechnics

Director: prof. Man Teodor Eugen

Contact: [eugen.man@upt.ro](mailto:eugen.man@upt.ro) <http://www.ct.upt.ro/centre/cchpm.htm>



## Research Centre for Building Services

Director: prof. Borza Ioan

Contact: [ioan.borza@upt.ro](mailto:ioan.borza@upt.ro)



## Research Centre for Retrofitting of Constructions

Director: prof. Stoian Valeriu

Contact: [valeriu.stoian@upt.ro](mailto:valeriu.stoian@upt.ro), <http://www.ct.upt.ro/centre/reco.htm>

Research projects under implementation can be found at pages: 65-68;



## Research Centre for Construction and Transportation Substructures

Director: prof. Marin Marin

Contact: [marin.marin@upt.ro](mailto:marin.marin@upt.ro)

Research projects under implementation can be found at pages: 141;



## Research Centre for Mechatronics and Robotics

Director: prof. Maniu Inocențiu

Contact: [inocentiu.maniu@upt.ro](mailto:inocentiu.maniu@upt.ro)

Research projects under implementation can be found at pages: 69-72



### Research Centre for Medical Engineering

Director: prof. Toth-Tașcău Mirela  
Contact: [mirela.toth-tascau@upt.ro](mailto:mirela.toth-tascau@upt.ro), <http://cmpicsu.upt.ro>



### Research Centre for Integrated Engineering

Director: prof. Drăghici George  
Contact: [george.draghici@upt.ro](mailto:george.draghici@upt.ro), [http://www.eng.upt.ro/imf/ccii/index\\_en.html](http://www.eng.upt.ro/imf/ccii/index_en.html)  
Research projects under implementation can be found at pages: 54;



### Research Centre for Processing and Characterization of Advanced Materials

Director: conf. Radu Bogdan  
Contact: [bogdan.radu@upt.ro](mailto:bogdan.radu@upt.ro), <http://eng.upt.ro/ccpcma>  
Research projects under implementation can be found at pages: 73-84;



### Research Centre for Complex Fluid Systems Engineering

Director: prof. Susan-Resiga Romeo  
Contact: [romeo.resiga@upt.ro](mailto:romeo.resiga@upt.ro), <http://mh.mec.upt.ro/cnisfc>  
Research projects under implementation can be found at pages: 85-90; 137-138;



### Research Centre for Thermal Machines and Equipments, Transportation and Environmental Pollution Control

Director: prof. Ionel Ioana  
Contact: [ioana.ionel@upt.ro](mailto:ioana.ionel@upt.ro)  
Research projects under implementation can be found at pages: 93-101; 117-120;



### Research Centre for Engineering and Management

Director: prof. Izvercianu Monica  
Contact: [monica.izvercianu@upt.ro](mailto:monica.izvercianu@upt.ro), <http://www.mpt.upt.ro/pag/centru%20cercetare.html>



### Research Centre for Urban Planning

Director: prof. Radoslav Radu  
Contact: [radu.radoslav@upt.ro](mailto:radu.radoslav@upt.ro), <http://ccddt.blogspot.ro>



### Research Centre for Advanced Study Methods for Physical Phenomena

Director: prof. Toader Dumitru  
Contact: [dumitru.toader@upt.ro](mailto:dumitru.toader@upt.ro)



### Research Institute for Renewable Energy

Contact: [www.icer.ro](http://www.icer.ro)



## Projects supported by public funds



## Research Projects

Field	Total number of projects	Source of financing	Number of projects
Computers and Information Technology	3	National Funds* Cross-border Cooperation HU-RO	2 1
Systems Engineering	4	National Funds International Programs**	3 1
Electronics and International Telecommunication Engineering	2	International Programs** Cross-border Cooperation HU-RO	1 1
Chemical Engineering	8	National Funds Cross-border Cooperation HU-RO	7 1
Civil Engineering	7	National Funds International Programs Cross-border Cooperation HU-RO	2 4 1
Industrial Engineering	2	National Funds International Programs	1 1
Materials Engineering	7	National Funds Structural Funds***	6 1
Mechanical Engineering	7	National Funds International Programs Cross-border Cooperation HU-RO Cross-border Cooperation RO-SR	3 1 2 1
Mathematics	2	National Funds	2
Learning	1	International Programs	1
Health	1	National Funds	1

\* National Funds - funds awarded by the Romanian govern through UEFISCDI

\*\* International Programs - EU 7<sup>th</sup> Framework Program, Research Fund for Coal and Steel or the Information and Communication Technologies Policy Support Program

\*\*\* Structural Funds - European Regional Development Fund, European Social Fund and the Romanian National Authority for Scientific Research





## Successful Project

### HSS-SERF – HIGH STRENGTH STEEL IN SEISMIC RESISTANT BUILDING FRAMES

#### Goal of the project

The aim of the project was to investigate and evaluate the seismic performance of dual-steel building frames, realized from two different steel grades: Mild Carbon Steel (MCS) and High Strength Steel (HSS). Specific objectives of the research project were represented by the following: (i) to find reliable structural typologies and connection detailing for dual-steel building frames, and to validate them by tests and advanced numerical simulations; (ii) to develop design criteria and performance based design methodology for dual-steel structures; and (iii) to evaluate the technical and economical benefit of dual-steel approach involving high strength steel.

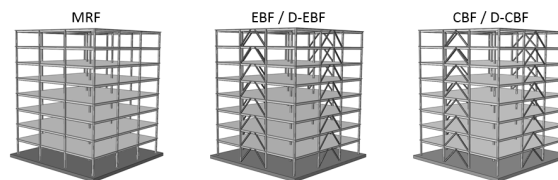

#### Short description of the project

Multi-storey frame structures of high strength steel members represent an innovation in seismic design in Europe. This type of structures in which mild carbon steel is used in dissipative members while high strength steel is used in non-dissipative “elastic” members, can be reliable and cost efficient.

A robust seismic resistant structure should be provided with balanced stiffness, strength and ductility among component members and connections. According to the dissipative design philosophy, such a structure will be able to dissipate a part of the energy induced by the ground motion, through plastic deformations in the dissipative zones of ductile members, e.g. beams in Moment Resisting Frames (MRF), links in Eccentrically Braced Frames (EBF), and braces in Centrically Braced Frames (CBF). In order to avoid the premature collapse of the structure, development of plastic hinges in columns has to be prevented. To ensure such a scenario, in case of MRF's, for instance, the strong column–weak beam (SC-WB) concept applies, which in fact means to provide enough overstrength of the column with respect to adjoining beams.

In order to get an economic design of a structure, dissipative elements have to approach their plastic capacity under design forces, in order to reduce the demand on non-dissipative members (overstrength should be limited). The best way to accomplish this is not to reduce the cross-section of dissipative members and to increase the size of non-dissipative ones, but to use instead Mild Carbon Steel and High Strength Steel. To compensate for the loss of stiffness – important in MRF's of HSS columns, inherent due to reduction in steel cross-section, and to increase their axial compression strength – important in case of CBF and EBF typologies, and also to enhance fire resistance, the columns can be realized in composite solution.

Based on this conceptual framework, the purpose of “HSS-SERF” project was to investigate the seismic performance of dual-steel building frames, in order to evaluate the effectiveness of such solutions, compared with current homogeneous steel concept. MCS was aimed to be used in dissipative members, e.g. those in charge to develop plastic deformations under design earthquake action, and HSS was aimed to be used in non-dissipative members, designed to remain predominantly elastic during earthquake.

Dual-steel structures enable to fulfil by design the three critical tasks of a robust structure: (i) to secure plastic deformation capacity in structural members, targeted as dissipative, which are key members in any seismic-resistant structure; (ii) to prepare multiple routes for transfer of forces and ensure their redistribution through yielding of other members; (iii) to provide sufficient overstrength to structural members that cannot be allowed to collapse at any cost. In dual-steel structures, the role of lower-yield steel is to work like a fuse, dissipating the seismic energy through plastic deformations, while the rest of the structure remains elastic or undamaged. To achieve these global performance targets, a proper detailing is compulsory, mainly for beam to column joints, in which by conception and sizing, a good balance between dissipative and non-dissipative components is needed.

## Project implemented by

The Research Center for Mechanics of Materials and Structural Safety – CEMSIG, Politehnica University of Timișoara.

## Research Team

- UPT - Politehnica University of Timișoara, Romania (project coordinator)
- RIVA - RIVA Acciaio S.p.A, Italy
- VTT - Technical Research Centre of Finland
- ULG - University of Liege, Belgium
- USTUTT - University of Stuttgart, Germany
- UNINA - University of Naples "Federico II", Italy
- UL - University of Ljubljana, Slovenia
- GIPAC - Gabinete de Informática e Projecto Assistido por Computador Lda., Portugal
- RUUKKI - Ruukki Construction Oy, Finland
- UPI - University of Pisa, Italy

## Main activities

The research activities of the project were divided into several working packages. The flowchart of the research is illustrated in the figure below

According to the flowchart of research, the main activities can be summarized as follows:

- Design and evaluation of the seismic performance of dual-steel multi-storey frames;

According to the flowchart of research, the main activities can be summarized as follows:

- Design and evaluation of the seismic performance of dual-steel multi-storey frames;
- Investigation of weld details and T-stubs (in correlation to welded and bolted joint assemblies);
- Investigation of bolted beam-to-column joints with columns realized as partially encased wide flange sections (PE-WF), and respectively concrete filled tubes (CFT);
- Investigation of welded beam-to-column joints with columns realized as fully encased wide flange sections (FE-WF), and respectively concrete filled tubes (CFT);
- Investigation of load introduction for CFT columns through the use of long bolts / shot fired nails;
- Elaboration of guidelines for conceptual design and performance based design (PBD) of dual-steel building frames under seismic actions;
- Evaluation of technical and economic efficiency of dual-steel structures;

In relation to the general flow chart of research, the following table summarises all working packages and nominates for each Working Package, the WP Leader and the Partners involved in the realisation of the specific tasks.

## Implementation period

01.07.2009 – 30.06.2013.

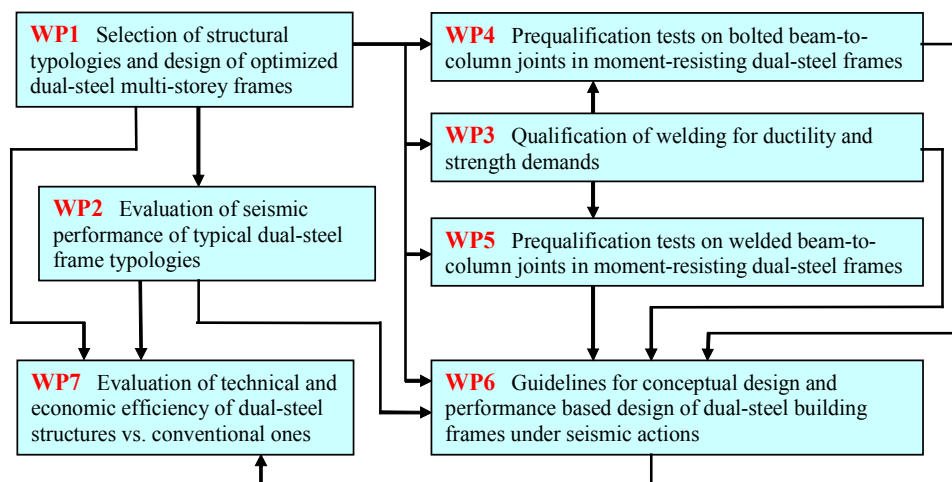

WP	WP Leader	Partners involved
WP1	GIPAC	UPT, VTT, ULG, UNINA, UL
WP2	UNINA	UPT, VTT, GIPAC
WP3	USTUTT	RIVA, ULG, UL, RUUKKI
WP4	ULG	RIVA, USTUTT, RUUKKI
WP5	UL	UPT, RIVA, USTUTT, RUUKKI
WP6	VTT	UPT, ULG, USTUTT, UNINA, UL, GIPAC, UPI
WP7	RIVA	UPT, VTT, UNINA, GIPAC, RUUKKI, UPI
WP8	UPT	RIVA, VTT, ULG, USTUTT, UNINA, UL, GIPAC, RUUKKI

## Results

A set of dual-steel multi-storey frames (moment resisting, dual concentrically braced and dual eccentrically braced) were designed according to the Eurocodes, and their seismic performance was evaluated in the first phase, using pushover analysis (see illustrations below).

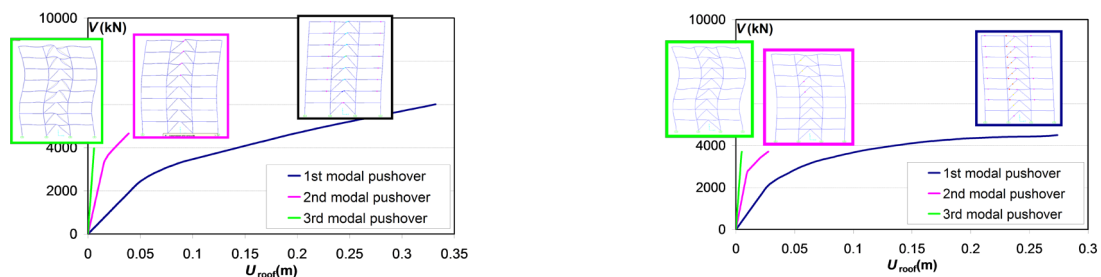

The design of the multi-storey frames allowed identification of realistic member sizes for both mild carbon steel beams and high strength steel composite columns. Several practical solutions for bolted and welded beam-to-column joints were identified and designed. These are: bolted joints with hammer-heads, joints with long bolts for concrete filled tubes, welded joints with fully encased wide-flange columns and rib or cover plate stiffened beam, as well as welded joints with concrete filled tube columns and reduced beam section and cover plate stiffened beam. In addition, new T-stub configurations (with long bolts and box section) whose design is not covered by Eurocode rules, were identified and considered further in the experimental program. The joint detailing and an illustration of the reduced beam section (RBS) and cover plate (CP) joints, which were investigated at the Politehnica University of Timișoara, are shown in the figure below.

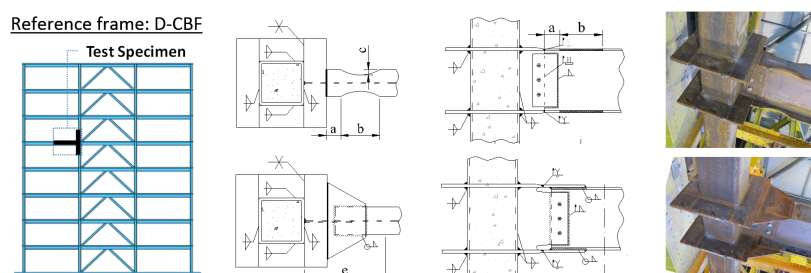

Further on, the initial set of frames was extended to include standard concentrically and eccentrically braced frames, two additional height ranges, two span ranges, and two different types of seismic action (corresponding to stiff and soft soil). Dynamic nonlinear analyses were carried out in order to assess seismic performance of this large collection of steel structures (120 cases in total).

An extensive experimental program was conducted at four Universities (i.e. University of Stuttgart, University of Liege, University of Ljubljana, and Politehnica University of Timisoara), covering investigations of material samples, weld details, bolted T-stub specimens, bolted and welded beam-to-column joints, and steel-concrete shear connection. The test set-ups are illustrated below.



The main results obtained from the seismic performance evaluation of the dual-steel multi-storey frames, and from the experimental investigations can be summarized as follows:

- The use of HSS was proven to be an efficient solution especially in columns for CBF's (simple & dual), and in both columns and braces for EBF's (simple & dual); in contrast, the use of HSS was not an effective solution for MRF's, the seismic design procedure being governed by damage limitation;
- MRF's evidenced an adequate seismic performance with low ductility demands, and the exhibited overstrength was larger than the behaviour factor used in design;
- CBF's: the dual-system structures presented higher overstrength and behaviour factors compared to the simple solutions; however, in all cases the behaviour factors were smaller compared to the values from EN 1998-1, mainly due to the large brace ductility demand in compression; although, EN 1998-1 makes no difference between the soil condition regarding to overstrength and behaviour factors, the frames designed on soft soil presented smaller overstrength and behaviour factors;
- EBF's: the static and dynamic analyses showed that the performance of the structures designed according to EN 1998-1 was affected by the brace buckling; consequently, the behaviour factors were significantly lower compared to the values recommended by EN 1998-1; the same set of structures designed with modified capacity design criterion showed an effective performance avoiding the brace buckling, thus experiencing behaviour factors consistent to the codified values;
- The experimental investigations performed on weld details validated the adopted welding procedure, as the failure occurred in the base metal in all cases; in addition, the tests on T-stubs confirmed that the end-plate can be designed (choice of thickness and steel grade), in order to achieve sufficient ductility as requested by code provisions;
- The tests on bolted beam-to-column joints confirmed the appropriate behaviour of the proposed solutions; in addition, new analytical design rules for specific joint components that are not accounted in EN 1993-1-8, were developed and validated;
- The tests on welded beam-to-column joints evidenced a good conception and design, justified by the quasi-elastic response of the connection zone and the formation of the plastic hinge in the beam; the axial force in the columns did not influence significantly the performance of the joints;
- The load introduction tests proved that the connectors (shot fired nails) have a significant contribution to the load transfer from steel tube to concrete core, in monotonic and cyclic loading;
- An evaluation of the seismic performance of the joints was performed, and corresponding to the Significant Damage performance level, all joint configurations evidenced rotation capacities larger than 40 mrad, and therefore the seismic performance of the joints was considered acceptable;
- The state of the joints corresponding to the three performance levels (see illustrations below) was observed to reflect in a realistic manner the definition of the performance level: Damage Limitation (DL - light damage, with the component retaining the initial strength and stiffness), Significant Damage (SD - significant damage, with some margin against total collapse of the component), Near Collapse (NC - heavy damage, with low residual strength and stiffness of the component).

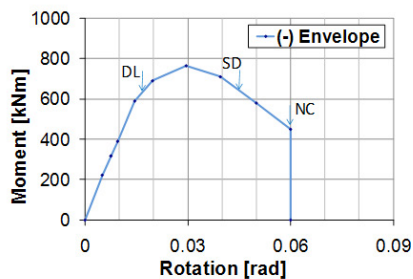

Damage Limitation



Significant Damage



Near Collapse

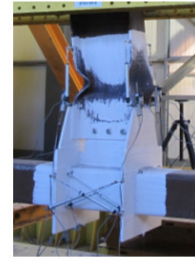

In addition to the experimental program, extensive numerical investigations were carried out for the beam-to-column joints. The first phase consisted in the calibration of the numerical models of the joint configurations based on the monotonic and cyclic test results. From the calibration, a set of numerical models were obtained which were capable to reproduce with a good accuracy the response of the joints in both moment-rotation curve and failure mechanism (see figures below). The second phase consisted in the extension of the experimental program with the aim to assess the influence of different parameters on the joint behaviour, e.g. influence of the concrete core, influence of the axial force in the column, and the behaviour of joints connecting two and respectively four beams. The numerical simulation program helped to achieve a better understanding of the joint behaviour, and allowed the development and validation of simple design procedures for the studied joint configurations.

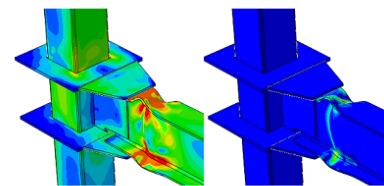
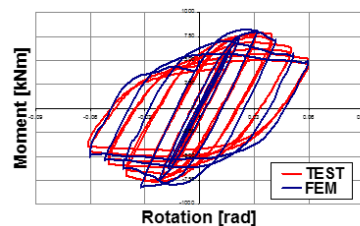
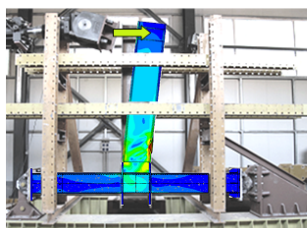

The outcomes of the activities related to – design of dual-steel frames and evaluation of the seismic performance, design and detailing of beam-to-column joints, experimental investigation of weld details, T-stubs, bolted and welded beam-to-column joints – represented the main part of the Guidelines for conceptual design and performance based design of dual-steel building frames under seismic actions. Consequently, the main topics were related to: design and detailing rules for connections and joints, design methodology and criteria for MRF's, CBF's and EBF's. Conceptual design guidelines had the objective to provide the designer with information on structural configurations for which the dual-steel concept and composite action are an efficient alternative to conventional solutions. The objective of the performance based design was to provide more in-detail guidance for the design of seismic resistant structures using the dual-steel concept and composite action. Last but not least, the design and detailing rules for connections and joints aimed to provide a ductile local and overall response. The final activities were related to the evaluation of technical and economic efficiency of dual-steel structures vs. conventional ones, realized from a single grade of mild carbon steel, in order to establish conditions in which dual-steel structures are to be employed in practice. The main tasks covered the evaluation of the technical and economic efficiency of MRF's, CBF's, and EBF's.

## Applicability and transferability of the results

The results are directly transferable to the steel industry and to the world of structural design of steel constructions, aiming to develop and harmonize production and design regulations. The expected advantages of HSS Dual-Steel structural solutions will allow promoting steel and steel-concrete composite constructions with respect to reinforced concrete solutions, actually more widespread in seismic countries, in Europe and outside of Europe. In recent years, significant developments in steel processing allowed obtaining high strength steels (HSS). Nowadays, in Japan and USA, HSS's are widely used for bridge and building construction. On the contrary, in Europe there are still a limited number of applications on buildings, and especially in seismic regions, although some examples exist for the use of HSS in bridge structures. The use of high strength steel within seismic resistant structures could be done considering two approaches: (i) dual-steel structures in which MCS is used for dissipative members and HSS is used in non-dissipative members; (ii) structures realized of HSS, i.e. S460 which is characterized by a certain amount of ductility and therefore could be used in structures of medium ductility class (DCM).



The research activities conducted within “HSS-SERF” project showed that the use of high strength steel in non-dissipative members (i.e. columns of CBF’s & D-CBF’s, respectively columns and braces of EBF’s & D-EBF’s) was proven to be an efficient solution. Three types of composite columns were considered in the study, i.e. PE-WF, FE-WF and CFT. Bolted and welded connection solutions were developed with the aim to achieve full strength beam-to-column joints for MRF’s and moment resisting bays of the dual braced frames. Generally, it can be stated that all the proposed connection solutions have an innovative character, and their structural performance was confirmed by experimental investigations. A particular advantage of the composite columns is related to their improved resistance to fire, and for this reason, these are preferred over the bare steel columns. For example, in Japan and other Asian countries, tubular steel sections are frequently used in multi-storey frame structures, and therefore the investigated structural typologies and joint solutions have large application perspectives also in Europe.

The research project “DUAREM” – Full-scale experimental validation of dual eccentrically braced frame with removable links, represents an eloquent application of the “HSS-SERF” project. “DUAREM” project involves a full scale pseudo-dynamic test of a dual structure (Eccentrically Braced Frame combined with Moment Resisting Frames) realized using the dual-steel concept.

The proposed research aims at reducing the repair costs and downtime of a structure hit by an earthquake, and consequently more rational design approach in the context of sustainability. These objectives are to be attained through removable dissipative members and re-centering capability of the structure. The bolted links are intended to provide the energy dissipation capacity and to be easily replaceable, while the more flexible moment resisting frames would provide the necessary re-centering capability to the structure. The moment resisting frames and the columns of the eccentrically braced frames were fabricated from high strength steel, in order to keep these members in the elastic range even under strong seismic input. The full-scale pseudo-dynamic tests will be performed at the ELSA facility of the Joint Research Centre in Ispra (Italy), and will enable a realistic evaluation and validation of the structural concept and dual-steel solution.

## Fields of interest

Seismic resistant structures for multi-storey building frames

## Research centre

Research Centre for Mechanics of Materials and Structural Safety – CEMSIG

## Financed through/by

Research Fund for Coal and Steel

- Total budget of “HSS-SERF” project: 1.763.026 €
- Budget of the Politehnica University of Timisoara: 169.560 €



## Dissemination of results:

- High Strength Steel in Seismic Resistant Building Frames (HSS-SERF). D. Dubina et al., Final Technical Report, RFCS, Steel RTD, RFSR-CT-2009-00024, 2014.
- D. Dubina, A. Stratan, C. Vulcu, A. Ciutina, (2014), High Strength Steel in Seismic Resistant Building Frames, EUROSTEEL 2014, September 10-12, 2014, Naples, Italy.
- Proceedings of the International Workshop: "Application of High Strength Steels in Seismic Resistant Structures", 28-29 June 2013, Naples, Italy. Editors: D. Dubina, R. Landolfo, A. Stratan, C. Vulcu, Editura "Orizonturi Universitare", ISBN: 978-973-638-552-0, (2014).
- C. Vulcu, (2013), Seismic Performance of Dual-Steel Frames of CF-RHS and Welded Beam-to-Column Joints – Ph.D. Thesis, Editura Politehnica, Timisoara, Romania, ISBN: 978-606-554-631-8.
- C. Vulcu, A. Stratan, A. Ciutina, D. Dubina, (2014), Experimental Evaluation of the Steel-Concrete Connection in Case of Concrete Filled Rectangular Hollow Section (CF-RHS) Columns, Proceedings of the International Workshop "Application of High Strength Steels in Seismic Resistant Structures". Editura "Orizonturi Universitare", ISBN: 978-973-638-552-0, pp. 95-104.
- C. Vulcu, A. Stratan, A. Ciutina, D. Dubina, (2014), Experimental Evaluation of Welded Reduced Beam Section (RBS) and Cover Plate (CP) Beam-to-CF-RHS Column Joints, Proceedings of the International Workshop "Application of High Strength Steels in Seismic Resistant Structures". Editura "Orizonturi Universitare", ISBN: 978-973-638-552-0, pp. 105-120.
- C. Vulcu, A. Stratan, A. Ciutina, D. Dubina, (2014), Numerical Investigation of Welded RBS and CP Beam-to-CF-RHS Column Joints, Proceedings of the International Workshop "Application of High Strength Steels in Seismic Resistant Structures". Editura "Orizonturi Universitare", ISBN: 978-973-638-552-0, pp. 121-136.
- C. Vulcu, A. Stratan, D. Dubina, S. Bordea, (2012), Seismic Performance of Dual Frames with Composite CF-RHS High Strength Steel Columns, 15th World Conference on Earthquake Engineering, 24-28 September 2012, Lisbon, Portugal.
- C. Vulcu, A. Stratan, D. Dubina, (2012), Seismic Performance of EB Frames of Composite CFHS High Strength Steel Columns, Proceedings of the 10th International Conference on Advances in Steel Concrete Composite and Hybrid Structures, ASCCS 2012, Singapore, ISBN-13: 978981-07-2615-7, ISBN-10: 981-07-2615-5, pp. 953-960, 2-4 July 2012.
- C. Vulcu, A. Stratan, D. Dubina, (2011), Evaluation of Welded Beam-to-CFT Column Joints, 6th European Conference on Steel and Composite Structures, EUROSTEEL 2011, 31 August – 2 September 2011, pp 489-494, Budapest, Hungary.

## Contact information

Prof. Dr. H. C. Dan DUBINĂ, PhD  
Corresponding Member of Romanian Academy  
Department of Steel Structures and Structural Mechanics, Faculty of  
Civil Engineering  
Address: Str. Ioan Curea, No. 1, RO300224, Timisoara  
Phone: (+40) 256 403 920  
E-mail: dan.dubina@upt.ro





## GREENER MOBILE SYSTEMS BY CROSS LAYER INTEGRATED ENERGY MANAGEMENT

### Goal of the project

The GEMSCCLAIM project aims at introducing novel approaches for reducing the “greed for energy” of modern battery powered systems, thereby improving the user experience and enabling new opportunities for mobile computing .

### Short description of the project

Mobile terminals and consumer devices are among the fastest growing markets in computing. In the long term, further growth is endangered by the “power/ energy wall”. The purpose of GEMSCCLAIM is to explore new techniques in energy optimization via an interdisciplinary vertical approach: a novel combined optimization across the major HW/SW system layers (compiler/OS/HW platform).

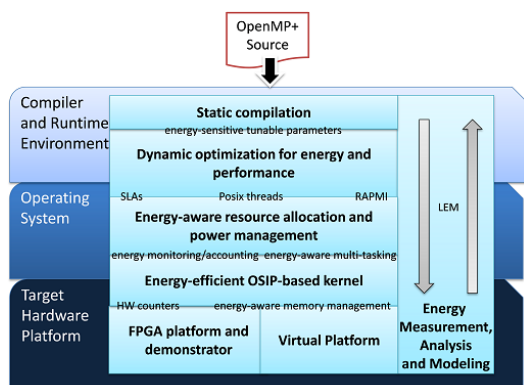

### Main activities

In a world of de-facto standards as well as huge amounts of legacy HW and SW, it is very difficult to achieve real breakthrough in system-wide energy savings beyond fragmented point solutions, e.g. at the HW or OS level.

GEMSCCLAIM’s mission is to overcome this hurdle by a novel cross layer energy optimization approach that combines the following major research activities: (1) Development of an energy-aware optimizing and parallelizing compiler; (2) Component aware energy-efficient operating system and (3) Customizable HW modelling with energy monitoring facilities.

### Project implemented by

Mobile Computing, Sensors Network and Embedded Systems Research Laboratory

### Implementation period

01.09.2012-31.08.2015

### Results

(1) The Virtual Prototype of the experimental HW/OS/Compiler platform and (2) FPGA Prototype experimental HW/OS/Compiler with Power Monitors.

### Applicability and transferability of the results

Mobile HW/OS/SW solutions development

### Fields of interest

Heterogenous multi-core embedded systems

### Research centre

Research Centre for Computers and Information Technology

### Financed through/by

CHIST-ERA partnership projects,  
PNII-IDEI –1/CHIST-ERA/01.10.2012.

### Research team

Innsbruck University (LP), Queen’s University Belfast, RWTH Aachen University, Politehnica University of Timisoara:

Assoc. Prof. Marius Marcu (PI)

Dr. Oana Boncalo

Dr. Sebastian Fuicu

Dr. Gabriel Garban

Dr. Alexandru Amaricai

Dr. Razvan Bogdan

Ing. Lucian Bara

### Contact information

Assoc. Prof. Marius MARCU, PhD

Department of Computer Science

Address: Str. Vasile Pârvan, No.2, RO300223, Timisoara

Phone: (+40) 256 403 257/ (+40) 256 403 263

E-mail: marius.marcu@upt.ro

## FLOATING POINT ARITHMETIC UNITS FOR GRAPHICAL APPLICATIONS IN FPGAs

### Goal of the project

This project proposes to develop dedicated floating point architectures on FPGAs to suit the growing demand of graphic application on these platforms.

### Short description of the project

Recent studies indicate that FPGAs provide better watts/flops performance compared to graphical processing units (GPUs). Adding features such as flexibility and high degree of parallelism makes suitable candidates for implementing graphical accelerators on future embedded systems. The major novelty of the proposal consists in the design of high performance FP units using an efficient exploitation of the FPGA arithmetic resources, such as the embedded multipliers or block RAM modules. Thus, dedicated arithmetic units for reconfigurable devices will be provided. Two types of FP operations are targeted: multiply and multiply-accumulate architectures (used for matrix products, vector and matrix products and dot products) and combined division and square roots (used for matrix inversions, Euclidean distance computations, etc). These units will be the backbone of dedicated hardware accelerators (for vertex, geometry and pixel shader operations) for these types of applications.

### Project implemented by

University Politehnica of Timisoara, Computer Engineering Department

### Implementation period

Oct 2011 - Oct 2014

### Main activities

1. Development of FP multiply and MAF architectures for FPGA. FP multiply and MAF operations are especially important in multiplications between vector and matrices.
2. Development of FP combined division and square root for FPGA.
3. Development of hardware accelerators for graphic operations and applications implementation based on designed hardware.

### Research centre

Research Centre for Computers and Information Technology

### Results

We have provided floating point units for very high radix division and square root. These units have the smallest DSP count for multiplication based division/square root methods. On the other hand, we have researched floating point units for multiplication and multiply-add fused operations. We have provided a hybrid integer-floating point multiplier and a high performance floating point multiply-add fused which relies on architectures of the DSP blocks in modern FPGAs. Our research has resulted in one ISI rated journal paper and four published or accepted conferences.

### Applicability and transferability of the results

A major goal of the research is represented by providing adequate floating point support for Open Hardware initiatives. We intend to add high performance floating point functionality to open source graphics accelerators, such as the one provided for OpenRISC based platforms.

### Financed through/by

CNCS PNII Human Resources - Young Researchers

### Research team

Dr. Alexandru Amaricai - Principal Investigator, Assoc. Prof. Marius Marcu, Prof. Mircea Popa, Dan Chiciudean, Ovidiu Sicoe.

### Contact information

Assist. Prof. Alexandru AMARICAI, PhD  
Department of Computer Science  
Address: Str. Bd. Vasile Pârvan, No. 2, RO300223, Timisoara  
Phone: (+40) 256 403 272  
E-mail: alexandru.amaricai-boncalo@upt.ro  
Web: www.cs.upt.ro/~amaricai/flag.html

## JOINT CROSS-BORDER INTERNET COMMUNICATION SYSTEM OF THE UNIVERSITY OF DEBRECEN AND POLITEHNICA UNIVERSITY OF TIMIȘOARA

### Goal of the project

The overall goal of the project is to enable enhanced capacity for cross-country cooperation and interaction between and within the participating universities by providing high quality WiFi system and IP streaming system for the students, professors and researchers at the University of Debrecen and Politehnica University of Timisoara, aiming at supporting the synchronization of educational, research and development, and other scientific activities of the cooperating universities

### Short description of the project

Interior and exterior WiFi service will be installed at both sites to be able to access from mobile notebooks and smart phones the partners data and services infrastructure and Internet services.

The project implements the EDUROAM service in PUT. This common authentication service with other universities within Europe allows accessing WiFi Internet, increases the Internet accessibility for both academic partners and incoming students travelling to PUT and UD. IP streaming subsystem will be installed at both universities to be able to interchange the local multimedia content between the partners

### Project implemented by

University of Debrecen, UD – Lead partner  
Politehnica University of Timișoara, PUT – Project partner

### Main activities

- Communication activities;
- Establishment of the project architecture;
- Acquisition of the specific equipments.

### Implementation period

01.01.2013 - 31.05.2014

### Research team

The Romanian team: Mircea POPA, Marius MARCU, Sebastian FUICU, Răzvan BOGDAN, Oana AMARICĂI-BONCALO, Sorin JULEAN, Marian SALAVAT, Mihaela CIULEAN, Marinela BĂLUȚ

### Research centre

Research Centre for Computers and Information Technology

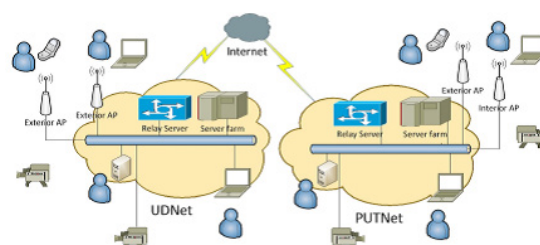

### Results

Several meetings took place, among them the project opening event and technical meetings. As a consequence the project architecture and the list of specific equipments was established. Also, the software requirements and solutions were obtained. The placement of the 200 Access Points covering the interior and exterior of the buildings of the faculties and student hostels from the campus was established. The specific infrastructures for implementing the EDUROAM service and the IP streaming service were determined.

### Applicability and transferability of the results

Achievement of a secure WiFi network covering a large area, offering also the EDUROAM service and IP streaming service. Possibility to develop research oriented on IP streaming, network traffic and main features.

### Financed through/by

Hungary-Romania Cross-Border Co-operation Programme

### Contact information

Prof. Mircea POPA, PhD  
Department of Computer Science  
Address: Bd. Vasile Parvan, No. 2, RO300223, Timisoara  
Phone/Fax: (+40) 256 403 003  
E-mail: mircea.popa@upt.ro

## DYNAMICAL SYSTEMS AND THEIR APPLICATIONS

### Goal of the project

The main objective of this project is to create fundamental understanding in dynamical systems theory and to apply this theory in formulating and analyzing real world models.

### Short description of the project

The specific objectives, tasks and methodology of the project are contained in 5 WPs. In WP1 we develop new methods for the center and isochronicity problems for analytic and non-analytic systems, study bifurcations of limit cycles and critical periods. In WP2 we deal with the problem of integrability for some differential systems with invariant algebraic curves, study global attractors of almost periodic dynamical systems, Levitan/Bohr almost periodic motions of differential/difference equations. The main objective of WP3 is to study dynamics of some classes of continuous and discontinuous vector fields. WP4 deals with Hamiltonian systems in Plasma Physics, twist and non-twist area preserving maps, numerical methods, and the study of symmetries of certain kinds of k-cosymplectic Hamiltonians. The last WP tackles mathematical models in Neuroscience and Medicine.

### Project implemented by

1. Politehnica University of Timisoara
2. West University of Timisoara
3. University of Craiova
4. Center za uporabno matematiko in teoreticno fiziko
5. Univerza v Mariboru
6. Universitat Autònoma de Barcelona

### Implementation period

1 oct 2012-30 sept 2016

### Main activities

1. Develop new methods and algorithms for studying the center and isochronicity problems.
2. Investigations of reaction-diffusion equations.
3. Study of differential and integral operators of non-integer order.
4. Study global attractors of almost periodic dynamical systems and their dynamical and topological structure.
5. Study dynamics of certain classes of continuous and discontinuous vector fields.

6. Study of Hamiltonian systems with  $1 \frac{1}{2}$  degrees of freedom and of their discrete correspondent, namely systems generated by area-preserving maps.

7. Investigations of ODE-based and map-based neuronal models such as.

### Results

To be published.

### Applicability and transferability of the results

The results will be relevant for dynamical systems theory and their applications.

### Financed through/by

FP7

### Research team

G. TIGAN, C. LAZUREANU, T. BINZAR, M. STELIAN, D. CONSTANTINESCU, R. CONSTANTINESCU, R. MILITARU, F. MUNTEANU, M. RACILA, N. VULPE, D. CHEBAN, A. SUBA, V. ROMANOVSKI, D. PAGON, D. COZMA, V. GROMAK, A.P. SADOVSKII, V.V. AMELKIN, N.L. SHCHEGLOVA.

### Research centre

Research Centre for Automatic Systems Engineering

### Contact information

Assist. Prof. Gheorghe TIGAN, PhD  
Department of Mathematics  
Address: P-ta Victoriei, No. 2, RO300006, Timisoara  
E-mail: gheorghe.tigan@upt.ro

## CONTROL ALGORITHMS AND OPTIMAL TUNING OF FUZZY MODELS FOR AUTOMOTIVE, MECHATRONICS APPLICATIONS AND MOBILE ROBOTS

### Goal of the project

Development of control structures and algorithms and optimal tuning of fuzzy models for a wide range of industrial processes, mechatronics, mobile robots and automotive applications.

### Short description of the project

The project aims:

- Development of advanced control structures for automotive and mechatronics applications.
- Improvement and development of new Takagi-Sugeno fuzzy models and control solutions for a wide range of industrial processes.
- Optimal tuning of fuzzy models for automotive and mechatronics applications.
- Improvement and development of control algorithms for mobile robots.

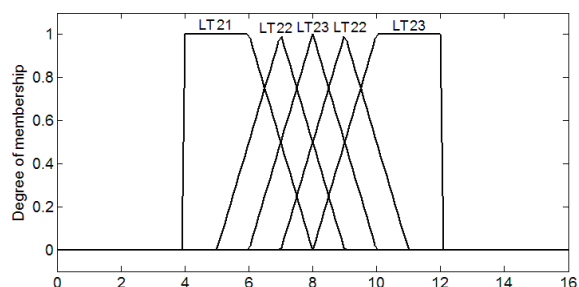

### Project implemented by

Department of Automation and Applied Informatics - P1 partner, coordinator: "Gheorghe Asachi" Technical University of Iasi (TUIASI), SC ROMUS Trading & Development SRL - P2 partner, director: Prof. Dr. Eng. Silvia Curteanu (TUIASI).

### Implementation period

2012-2015

### Main activities

Design of low-cost Takagi-Sugeno (T-S) state feedback fuzzy controllers for nonlinear dynamic systems.

Development and experimental validation of T-S fuzzy models of several processes in automotive and mechatronics applications.

Modelling, simulation, analysis and design of linear, variable

structure control and fuzzy solutions in one- and two-degree-of-freedom formulations for electrical drives with continuously variable reference inputs, load disturbance inputs and parameters. Optimal tuning of parameters of T-S fuzzy models using nature-inspired algorithms.

New path planning and collision avoidance algorithms for mobile robots based on nature-inspired algorithms. Low-cost controller designs for vehicle power train systems with spark-ignition engine and continuously variable transmission.

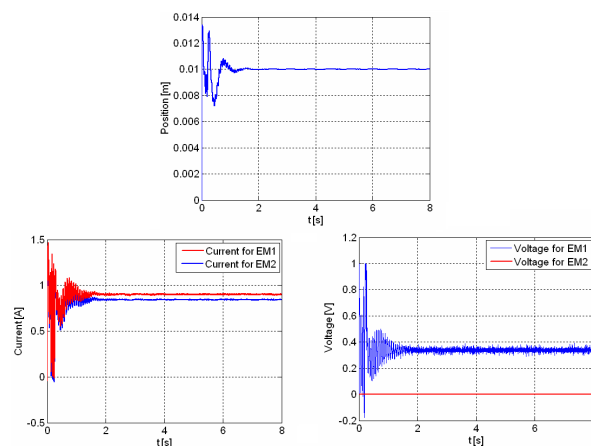

### Results

- Please visit: [http://www.romus.com/proiecte/asachi/pages/pages/phpsite\\_index.php](http://www.romus.com/proiecte/asachi/pages/pages/phpsite_index.php).
- 6 papers published in ISI journals with impact factors.
- 2 papers published in journals indexed by international databases.
- 16 papers published in conference proceedings indexed by international databases.
- More than 50 independent citations in 2013

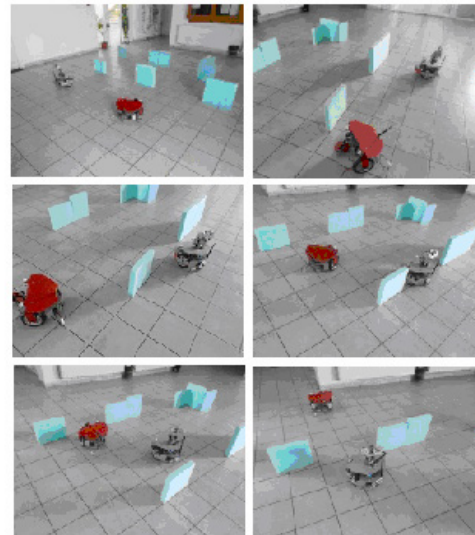
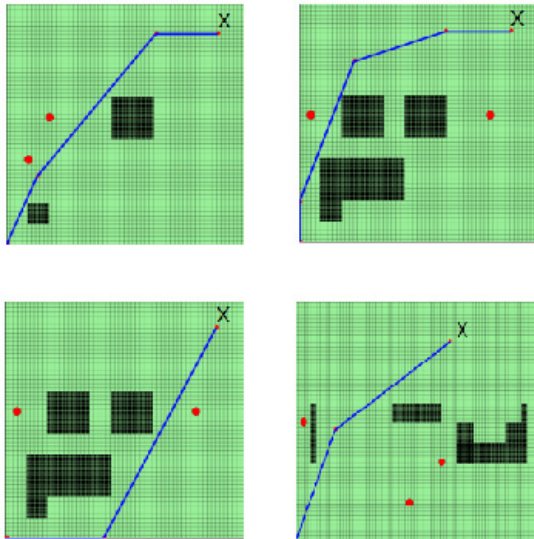

## Applicability and transferability of the results

Nature-inspired optimization algorithms in modelling, control design and navigation of mobile robots, low-cost solutions for control problems in mechatronics, electrical drives, automotive and robotics, tools for the modelling, optimization and design of fuzzy control systems, real-time programming and operating systems for control and robotics.

## Fields of interest

Control algorithms, optimal tuning, fuzzy models, nonlinear dynamic models, automotive, mechatronics, mobile robots, networked control systems, Programmable Logic Controllers, real-time programming, image processing.

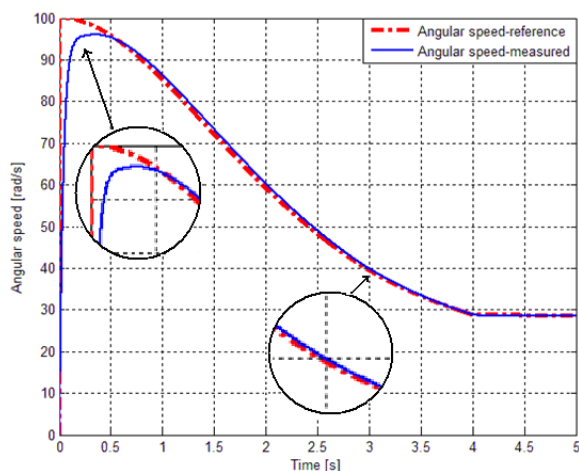

## Research centre

Research Centre for Automatic Systems Engineering (CCISA)

## Financed through/by

Executive Agency for Higher Education, Research, Development and Innovation Funding (UEFISCDI), Bucharest, Romania.

## Research team

Prof.Dr.Eng. Radu-E. Precup  
 Prof.Dr.Eng. Stefan Preitl  
 Prof.Dr.Eng. Ioan Filip  
 Assoc.Prof.Dr.Eng. Florin Drăgan  
 Lect.Dr.Eng. Adriana Albu  
 Lect.Dr.Eng. Ovidiu Baniş  
 Lect.Dr.Eng. Daniel Iercan  
 Assist.Lect.Dr. Eng. Claudia-A. Dragoş,  
 Assist.Lect.Dr. Eng. M.-Bogdan Rădac  
 Eng. Alexandra-I. Stînean - PhD student (PhD s.)  
 Eng. Lucian-O. Fedorovici - PhD s.  
 Eng. Constantin Purcaru - PhD s.

## Contact information

Prof. Radu-Emil PRECUP, PhD  
 Director of the CCISA Research Centre  
 Department of Automation and Applied Informatics  
 Address: Bd. Vasile. Pârvan, No. 2, RO300223 Timisoara,  
 Phone: (+40) 256 403 229  
 Fax: (+40) 256 403 214  
 E-mail: radu.precup@upt.ro  
<http://www.aut.upt.ro/centru-cercetare/index.EN.php>



## NEW PERFORMANCE IMPROVEMENT TECHNIQUES OF CONTROL SYSTEMS USING EXPERIMENT-BASED TUNING

### Goal of the project

Enhance the existing techniques and develop new techniques dedicated to the improvement of control system performance using experimental data.

### Short description of the project

The project aims:

- Enhancement and development of data-based (datadriven) techniques and algorithms for the improvement of control system performance using experimental data.
- Enhancement and development of nature-inspired algorithms in optimization of control system performance.
- Development of Optical Character Recognition (OCR) applications.
- Development of new fuzzy control solutions for a wide range of industrial processes.

### Project implemented by

Department of Automation and Applied Informatics  
<http://www.aut.upt.ro/~rprecup/grant2011.htm>

### Implementation period

2011-2014

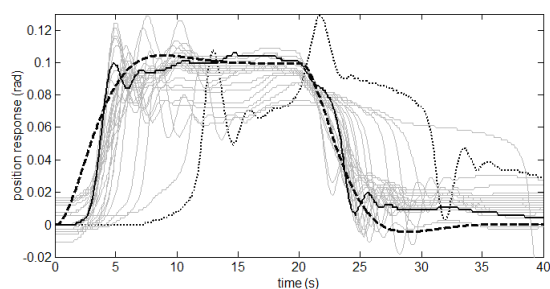

### Main activities

Experiment-based approaches to Reference Trajectory Tracking optimal control problems with constraints.

Validation of iterative techniques on laboratory equipment by speed and position control of nonlinear servo systems, and of aerodynamic systems.

Enhancement of control system performance by fuzzy control and Iterative Feedback Tuning.

Enhancement of nature-inspired algorithms such as Charged System Search and Gravitational Search Algorithms by adaptation.

Proportional-integral and fuzzy controller tuning to ensure a reduced sensitivity with respect to process parametric variations.

Enhancement of training algorithms of neural networks by Iterative Learning Control and by mixed Back-Propagation and nature-inspired approaches applied to automatic control and Optical Character Recognition.

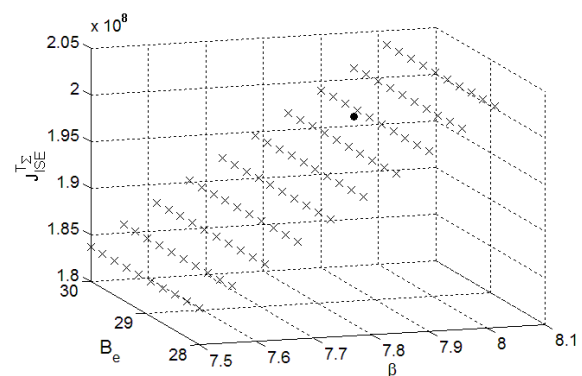

### Results

- Please visit <http://www.aut.upt.ro/~rprecup/grant2011.html>.
- 7 papers (ISI) published in journals with impact factors in 2013 (out of 21 reported for the research contract in 2012).
- 1 journal paper indexed by international database (Zentralblatt Math)
- 2 book chapters published in Springer-Verlag volumes.
- 11 papers published in conference proceedings indexed by international databases.
- 29 independent citations received in 2013 for the papers reported in the research contract in 2011-2013.

## Applicability and transferability of the results

Control systems with a reduced parametric sensitivity, tools for the computer-aided design of controllers, computer-aided techniques in iterative data-based control, nature-inspired optimization algorithms in control design and image processing, tools for the systematic development of fuzzy control systems.

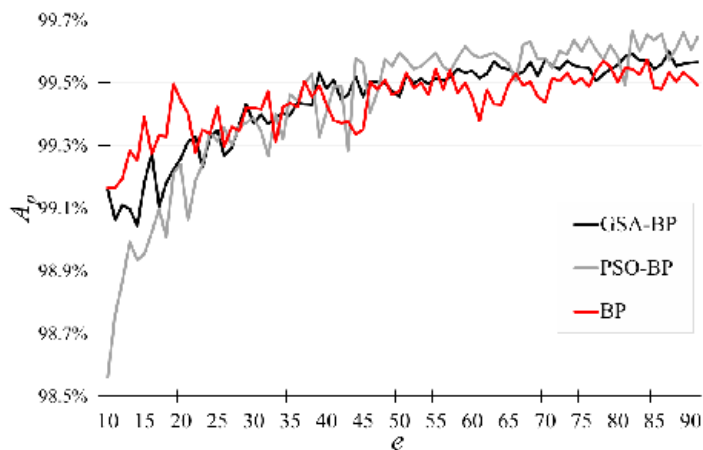
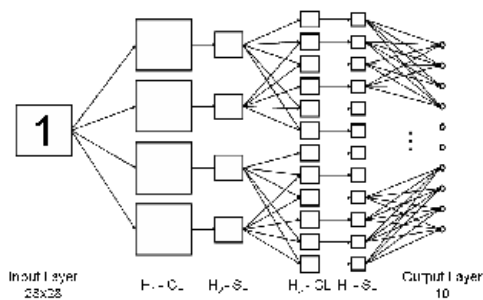

## Fields of interest

Control systems, optimization, motion control, data-driven control, robotics, nature-inspired algorithms, optical character recognition, fuzzy control.

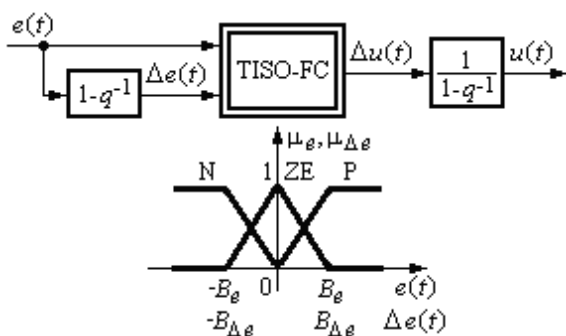

## Research centre

Research Centre for Automatic Systems Engineering (CCISA)

## Financed through/by

Executive Agency for Higher Education, Research, Development and Innovation Funding – UEFISCDI, Bucharest, Romania.

## Research team

Prof.Dr.Eng. Radu-Emil Precup – principal investigator,  
 Prof.Dr.Eng. Stefan Preitl – senior staff member (s.s.m.),  
 Assoc.Prof.Dr.Eng. Florin Drăgan – s.s.m.,  
 Lect.Dr.Eng. Daniel Iercan – post doc (p.d.),  
 Assist.Lect.Dr.Eng. Mircea-Bogdan Rădac – p.d.,  
 Assist. Lect.Dr.Eng. Claudia-Adina Dragoș – p.d.,  
 Dipl.Eng. Alexandra-I. Stînean – Ph.D. student,  
 Dipl.Eng. Lucian-O. Fedorovici – Ph.D. student.

## Contact information

PProf. Radu-Emil PRECUP, PhD  
 Director of the CCISA Research Centre  
 Department of Automation and Applied Informatics  
 Address: Bd. Vasile Pârvan, No. 2, RO300223 Timisoara  
 Phone: (+40) 256 403 229  
 Fax: (+40) 256 403 214  
 E-mail: radu.precup@upt.ro  
 Web: <http://www.aut.upt.ro/~rprecup/>



## HYBRID SYSTEMS FOR CONVERTING RENEWABLE ENERGY OF SMALL VOLTAGE, INTEGRATED INTO A MICRO-NETWORK

### Goal of the project

The project is focused on the research, development and testing of an intelligent and flexible (configurable) small scale power system based on integration of three renewable energy sources: wind, hydro, and solar (photovoltaic) power, adapted to the available resources in Romania, in various regions of the country, working independently or connected to the grid.

### Short description of the project

The project will cover the entire power conversion structure, including the design of adequate prime movers and new types of generators and power electronic converters, storage devices, power flow management system and load control. Some configurable structures (wind, micro-hydro and PV, all or a part of them, including their integration in a microgrid) will be proposed as experimental models, ready to be transferred to industry. There are proposed novelty elements regarding: low power wind turbine with integrated overspeed protection system, new generators configurations, and new topologies for power electronic converters and microgrid structures, optimal local control strategies and intelligent power system management.

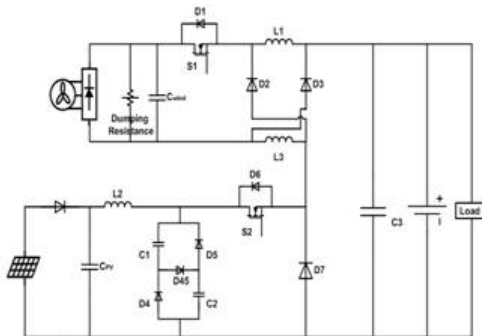

### Main activities

- Microgrid components modeling, simulation and design.
- Microgrid components manufacturing, individual testing and integration in the experimental setup.
- Design, implementation and validation of the control strategies for microgrid components.
- Design, implementation and validation of the microgrid control strategy.
- Results dissemination and know-how exchange.



### Results

- A new over-speed protection system for wind turbines.
- A new electrical reactive brushless dc generator with performances comparable with high energy PM generator, at low cost.
- A new RF-IPMSG with high efficiency, maintenance-free operation, and high-controllability.
- A new AF-PMSG optimised for modular design. A new multiphase inverter with adequate control for the proposed generators.
- New multi-input dc-dc converters with high efficiency.
- High power tandem inverters for load management.
- Hardware and software package for power management, power flow control, individual converter control, and MPPT and other control strategies.
- Experimental microgrid system with integrated photovoltaic, wind and hydro generation.
- Technical papers will be published in top international journals and conference proceedings.

### Research centre

Research Centre for Automatic Systems Engineering

### Project implemented by

Politehnica University of Timisoara – Project coordinator  
Technical University of Cluj-Napoca – Project partner  
SC EETIM SA – Project partner

### Implementation period

2012-2015

## Applicability and transferability of the results

All the research results are the property of the project coordinator and its partners.

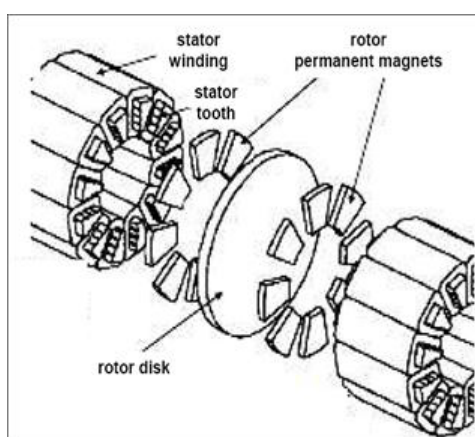

## Financed through/by

Joint Applied Research Projects - Partnership in S&T priority domains financed by the Executive Agency for Higher Education, Research, Development and Innovation Funding (UEFISCDI).



## Research team

UPT:  
Octavian PROSTEAN  
Nicolae MUNTEAN  
Nicolae BUDISAN  
Ioan FILIP  
Mircea BARGLAZAN,  
Gabriela PROSTEAN  
Stefan KILYENI  
Ilarie BORDEASU  
Teodor MILOS  
Cristian VASAR  
Lucian TUTELEA  
Cristian LASCU  
Sorin DEACONU  
Dan UNGUREANU  
Iosif SZEIDERT  
Adrian BEJ  
Radu BORACI  
Octavian CORNEA  
Ovidiu TIRIAN  
Rodica BADARAU .

## Contact information

Prof. Octavian PROSTEAN, PhD  
Department of Automation and Applied Informatics  
Address: Bv. Vasile Pârvan, No. 2, RO300223, Timisoara  
Phone: (+40) 256 403 225  
Fax: (+40) 256 403 214  
E-mail: octavian.prostean@upt.ro

## ARTRAC - ADVANCED RADAR TRACKING AND CLASSIFICATION FOR ENHANCED ROAD SAFETY

### Goal of the project

ARTRAC aims to develop an active safety system to protect vulnerable road users (VRUs) from vehicles in motion that is economically viable in the volume vehicle market. The safety system will consist of both actuators for controlling vehicle driving dynamics and the perception component for the vehicle's surroundings. It will be tested on two types of vehicles that pose the biggest hazard to VRUs in urban settings, namely cars and light delivery goods vehicles.

### Short description of the project

The environmental sensing used in ARTRAC project will be based on a single automotive 24 GHz narrowband radar sensor. This sensor offers the potential to overcome the hitherto price barrier that has prevented VRU protection systems from entering widespread use. To meet the challenging technical requirements for extremely short measurement time, reliable target detection, ego motion and road condition estimation that have to be met, a new transmit/receive antenna and multi-channel receiver will be developed. Existing microwave technology in the 24 GHz band is utilised as much as possible to facilitate low-cost mass production applications.



not be a show-stopper from a pure technical point of view. Measures for VRU protection might be divided into passive and active systems. Because of basic physical properties, passive measures can provide limited protection potential only. Therefore (active) actuators are necessary to achieve the desired protection for VRUs. For example, vehicle deceleration seems to be a potential approach for active VRU protection with high benefit and high potential for high volume series cars, as they are already in use in high-end limousines. The environmental sensing will be conducted with a novel high performance but low-cost 24 GHz narrowband radar system. From an operational viewpoint, this RF frequency fits exactly into the existing ISM band from 24,000 GHz to 24,250 GHz. Due to this techno-political feature this radar has a long term perspective on European and world-wide markets.

### Project implemented by

Consortium of seven institutions:

- 2 car manufacturers (VOLKSWAGEN, FIAT through CRF);
- 2 research organizations (VTT - Finland, CTAG - Spain);
- 2 universities (TUHH - Technical University Hamburg-Harburg, UPT - Timișoara);
- one SME specialized in car sensors (SMS Germany).

### Implementation period

November 2011 - October 2014

### Main activities

The whole system consisting of radar sensor, sensor fusion, risk assessment and vehicle control has a high potential to be launched in serial cars because the majority of components is already standard equipment in series cars. The additional equipment required should

### Results

ARTRAC address the following six major scientific and technical objectives:

- Develop a generic detection system able to detect pedestrians, cyclists, and other vulnerable road users (VRU) as well as vehicles.
- Implement the capability to monitor road surface conditions and detect low-friction road sections caused by water, ice or snow on asphalt. This will be able to be used to warn or adapt the vehicle's electronic control systems such as electronic stability control (ESC)
- Implement the capability to monitor road surface conditions and detect low-friction road sections caused by water, ice or snow on asphalt. This will be able to be used to warn or adapt the vehicle's electronic control systems such as electronic stability control (ESC) and collision avoidance systems (CAS) for changed friction conditions.

Studies developed by UPT research team for ARTRAC project in 2013

- Ioan Nafoarnita et al, ARTRAC "Denoising techniques applicable in Radar signal processing. Validation report", oct. 2013 ARTRAC meeting, Espoo, Finland.
- Ioan Nafoarnita et al, ARTRAC "Applying denoising methods for automotive Radar data (UPT Activity Report)", march 2013, Timisoara, Romania.
- Ioan Nafoarnita et al, ARTRAC Preliminary Report "Denoising techniques applicable in Radar signal processing"; february 2013 ARTRAC meeting, Timisoara, Romania.
- Adrian Macaveiu, Andrei Campeanu, Ioan Nafoarnita, Estimation of Automotive Target Trajectories by Kalman Filtering, Scientific Bulletin of the Politehnica University of Timisoara - Transactions on Electronics and Communications p-ISSN 1583-3380, vol 58(72) no.1, 2013, pp. 30-35.
- Adrian Macaveiu, Andrei Campeanu, "Automotive radar target tracking by Kalman filtering", 11th International Conference on Telecommunication in Modern Satellite, Cable and Broadcasting Services (TELSIKS), Vol. 2, pp. 553 - 556, Nis, Serbia, 2013.

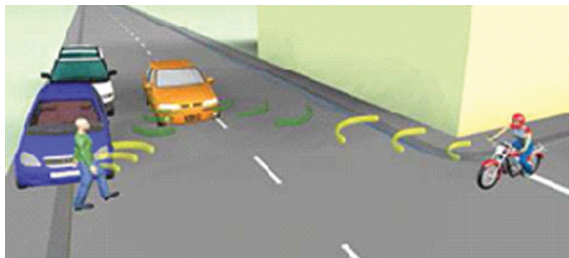

**ARTRAC road traffic scenario involving VRU's**

## Applicability and transferability of the results

The key result of the ARTRAC project will be a safety system that aims to protect vulnerable road users, designed to be economically viable in the volume vehicle market. The safety system will consist of both, actuators for controlling vehicle driving dynamics and the perception component for the vehicle's surroundings. The ARTRAC detection system will be small, lightweight and economical in order to enable an easy integration in the vehicle design.

## Fields of interest

Radar, sensor, vulnerable road users, protection, road condition detection, collision avoidance, assisted braking.

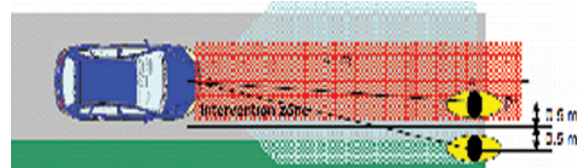

**ARTRAC car radar technical specifications**

## Research centre

Research Centre for Intelligent Signal Processing (ISPRC)

## Financed through/by

The project is 75% funded by the EU 7th Framework Program (FP7 No. 284740 - 126.030 €) and 25% by the national Program PNII (contract 223EU/24.07.2013 - 189.045 lei)

## Research team

Prof. Dr. Ing. Ioan Nafoarniță;  
Prof. Dr. Ing. Alexandru Isar;  
Prof. Dr. Ing. Andrei Câmpeanu;  
Conf. Dr. Ing. Corina Nafoarniță;  
Drd. Ing. Adrian Macaveiu.

## Contact information

Prof. Ioan NAFORNIȚĂ, PhD  
Corresponding Member of the Romanian Academy of Technical Sciences  
Department of Communications  
Address: Bd. Vasile Pârvan, No. 1, RO300223, Timisoara  
Phone/Fax.: (+40) 256 403 302  
Mobile: (+40) 722 567 912  
E-mail: ioan.nafoarnita@upt.ro  
Web: www.artrac.org

## STUDIES FOR ASSISTANCE TO COMMERCIALIZE INNOVATIVE RESEARCH RESULTS OF PROS IN TIMIS AND CSONGRÁD COUNTIES SERVING AS A PILOT FOR FUTURE PROJECTS

### Goal of the project

The project aims to strengthen the cooperation between Romanian and Hungarian innovation related public research organizations (PROs). We establish new contacts and exchange our expertise regarding technology transfer practices. The project develops the current relations of PROs on both sides of the border. Organizations can get information about "how-to-do" successful cross-border technology transfer and R&D service providing activities. The project will create business value from innovation.

### Short description of the project

Timis and Csongrád counties have significant intellectual capacity, however in the last few decades they have not been interwoven with such economic achievements that would raise the mentioned areas into the level of territories with developed knowledge-based economy. The problem is the low level of knowledge utilization in the counties. Because of the R&D orientation of the counties, there are relatively many inventions. However just a fairly low ratio of these are used. The technology transfer is still weak. The project aims to transmit knowledge by emphasizing the importance and the business benefits of the activity and by introducing the available services. Most of the PROs don't have adequate network of connections, don't know technology transfer networks and electronic databases about transmitting technologies, that are essential to be used for efficient TT activities. Therefore, the project intends to strengthen regional knowledge on technology transfer.



### Project implemented by

Politehnica University of Timisoara, Romania – lead partner  
Magyar Innovációs Szövetség (Hungarian Association for Innovation), Szeged, Hungary – project partner

### Implementation period

01.04.2012 – 31.03.2013

### Main activities

Creation of the COMINPRO database, online and on DVD, consisting of a list of organizations (research institutes and universities), mapped from Timis and Csongrad counties, with all their technological and research capabilities, accessible at <http://cominpro.cm.upt.ro/db>.

Development of a methodology for the identification of PROs and for the survey of PROs, created in order to identify the common research interests and the research results that can be commercialized, based on questions groups.

Creation of a general information package (information on technology transfer, studies, financial and legal information, presentations given, description of the events for promoting the selected technology offers and finding partners for the selected technology requests) and 18 tailor made studies.

### Results

- Database of PROs in Timis and Csongrad counties, with the indication of their technologies, developed both as an online tool and on DVD;
- Developed methodology for identification and survey of PROs;
- Test of the developed methodology on 20 different organizations;
- Database of joint R&D fields, identified through mapping the PROs in the two counties;
- General information package, available online and on DVDs in Hungarian, Romanian and English;
- 18 tailor made studies (6 for Hungarian PROs and 12 for Romanian PROs);
- Study regarding opportunities of future further joint co-operations in R&D between the two countries;
- 5 innovative technologies selected for cross-boarder transfer;
- 2 workshops organized with research organizations in order to disseminate practice in innovation transfer.



## Applicability and transferability of the results

The project will stimulate the commercialization of innovative research results. The knowledge and access to international information sources is available at the LP and the PP, who will use it in order to boost co-operation between Romanian and Hungarian R&D organizations. As a result of the identification of joint co-operation possibilities, further development will start between PROs in Timis and Csongrád. In addition, through development of joint methodology, the project serves as a pilot for establishment of solid cross-border relation, which can be extended to other counties later.



## Fields of interest

Research & development public organizations, innovation, innovative technologies, technology transfer, international databases for innovation and technology transfer, inter-regional co-operation, support for innovation infrastructure, cross-boarder technology transfer, cross-boarder research complementarity, cross-boarder sustainable development.



## Research centre

Research Centre for Multimedia

## Financed through/by

Hungary-Romania Cross-Border Co-operation Programme 2007-2013, European Regional Development Fund

## Research team

Radu VasIU, Marian Bucos, Muguras Mocofan, Diana Andone, Marian Mocan, Daniel Stan, Agnes Stepanian, Cristina Marchis.

## Contact information

Prof. Radu VASIU, PhD  
Multimedia Research Centre  
Address: Bd. Vasile Pârvan, No. 2, RO300223, Timisoara  
Phone/Fax: (+40) 256 403 300  
Email: radu.vasiu@upt.ro  
Web: www.cm.upt.ro, <http://cominpro.cm.upt.ro>

## IMPACT OF WASTE AND POLLUTANTS ON ENVIRONMENT AND CLIMATE: COLLABORATIVE RESEARCH STUDY OF THE WASTEWATER DISCHARGE IMPACT IN THE BEGA-TIMIS RIVER SUB-BASIN

### Goal of the project

The ultimate goal of this collaborative research study is the development of a robust methodology for the selection of water pollution control measures following the principles of eco-efficiency by developing a consistent DPSIR (Drivers-Pressure-State-Impact-Response) framework in Romania. The methodology is developed and will be validated in the Bega-Timis river (sub-) basin, which is part of the Danube river basin.

### Short description of the project

DPSIR framework will be applied to and validated in the Bega-Timis river basin.

The main pressures will be identified and characterized with indicators based analysis, overall environmental objectives will be clarified with stakeholder analysis applying a willingness to pay/accept-approach, state and impacts in the main rivers will be modeled and assessed in a GIS application.

Eco-efficient options to improve the situation (technologies, operational and organizational) will be identified with a multi-criteria analysis approach.

This holistic combination is new especially for Romania as in general the focus has been on the deployment of technical systems and not comprehensively analyzing the situation using a DPSIR framework in combination with stakeholder involvement and uncertainty analysis.

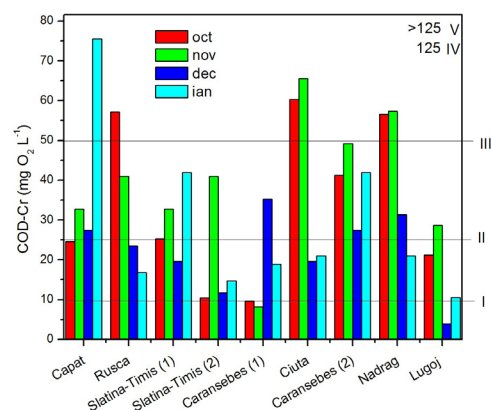

### Project implemented by

Swiss National Science Foundation (SNSF) and Romanian Executive Agency for Higher Education, Research, Development and Innovation Funding (UEFISCDI)

### Main activities

In this project, the activities are focused on the following work packages (WPs):

- WP1- Methodology and tool box development;
- WP2- Analysis of pollution sources, status and performance of the current wastewater treatment;
- WP3- Risks and impacts of the current and future emissions on the environment;
- WP4- Identification of eco-efficient environmental measures and technologies;
- WP5- Stakeholder analysis, information and capacity building;
- WP6- Dissemination of research results.

### Implementation period

01.01.2013 – 31.12.2014

## Results

A methodological DPSIR framework and sampling plan were developed based on available information from previous studies and implementation of the WFD in the study area.

A GIS (Geographic Information System) platform has been set up using a freeware application (QGIS) to provide a geographically explicit data basis required for the study, identify water quality 'hot spots' and lay the foundation for the subsequent analyses in the second year of the research.

The identification and analysis of water quality 'hot spots' in Timis-Bega sub-basin has been completed based on the methodological framework.

For a slaughterhouse company the QuickScan tool was already applied and potential measures for pollution mitigation and water consumption were identified.

## Applicability and transferability of the results

The developed eco-efficiency based DPSIR framework will help achieving relevant European legislative requirements, most notably the Urban Wastewater Treatment Directive (UWWTD), the Directive for Integrated Pollution Prevention and Control (IPPC), its successor the Industrial Emissions Directive (IED), and the Water Framework Directive (WFD), by economically feasible means.

The results of this study should contribute to the enhanced planning the measures to maintain and improve water status at river basin level in order to reach the overall objective of WFD.

## Financed through/by

SNSF and UEFISCDI



## Research centre

R research Centre for Environmental Science and Engineering

## Research team

Florica Manea – partner responsible  
Petru Negrea – senior researcher  
Rodica Pode – senior researcher  
Adina Negrea – researcher  
Alina Dumitrel – researcher  
Laura Cochechi – researcher  
Lavinia Lupa – researcher  
Aniela Pop – researcher  
Mihaela Ciopec – researcher  
Agnes Jakab – researcher  
Magdalena Ardelean – research assistant

## Contact information

Assoc. Prof. Florica MANEA, PhD  
Department of Applied Chemistry and Engineering of Inorganic Compounds and Environmental  
Address: Bd. Vasile Pârvan, No. 6, RO300223, Timisoara  
Phone: (+40) 256 403 070  
E-mail: florica.manea@upt.ro  
Web: <http://www.rsrp-bega-timis.org>



## NEW APPROACH OF USING IONIC LIQUIDS (ILS) AS GREEN EXTRACTANTS IN THE ADSORPTION PROCESS OF RADIONUCLIDES FROM WASTE AQUEOUS SOLUTIONS

### Goal of the project

The overall goal of the proposed project is to investigate a new approach of using the room temperature ionic liquid (RT IL) as extractants impregnated onto various solid supports in the adsorption process of radionuclides from waste aqueous solutions. The project has an interdisciplinary character presenting an integrated concept of waters depollution with radionuclides content.

### Short description of the project

The use of ionic liquids (ILs) so called "green extractants", instead of the volatile organic solvents as new separation media of metals from aqueous solutions is in agreement with the principle of the sustainable development and in full compatibility with the environment protection. Various ILs will be used, which will be impregnated onto various solid supports, and the resulted extractant impregnated materials (EIM) after characterization, will be used as adsorbent materials in the removal process of radionuclides from waste aqueous solutions. Using some solids supports impregnated with ILs as adsorbent materials is expected to achieve very good performance in the removal process of radionuclides from waste aqueous solutions because the adsorbent properties of the solid supports and the advantageous properties of ILs are combined, thus opening and establishing the new science based on both adsorption technology and ionic liquids.

### Project implemented by

Faculty of Industrial Chemistry and Environmental Engineering

Adsorbent	$q_m$ , mg/g
PAN/zeolite	0.011
Dolomite	1.172
Hydrous ceric oxide	0.106
Chromium (IV) oxide	0.055
Florisil impregnated with Cyphos IL-101	2.94
Silica impregnated with Cyphos IL-101	3.97

### Implementation period

01.05.2013–30.11.2015

### Main activities

The whole system consisting of radar sensor, sensor fusion, risk assessment and vehicle control has a high potential to be launched in serial cars because the majority of components is already standard equipment in series cars. The additional equipment required should not be a show-stopper from a pure technical point of view.

Measures for VRU protection might be divided into passive and active systems. Because of basic physical properties, passive measures can provide limited protection potential only. Therefore (active) actuators are necessary to achieve the desired protection for VRUs. For example, vehicle deceleration seems to be a potential approach for active VRU protection with high benefit and high potential for high volume series cars, as they are already in use in high-end limousines.

The environmental sensing will be conducted with a novel high performance but low-cost 24 GHz narrowband radar system. From an operational viewpoint, this RF frequency fits exactly into the existing ISM band from 24,000 GHz to 24,250 GHz. Due to this techno-political feature this radar has a long term perspective on European and world-wide markets.

### Results

The nature of the solid support used for the impregnation of various ionic liquids has a significant influence onto the adsorption properties of the obtained supported ionic liquids (SILs) in the removal process of various radionuclides from aqueous solutions. The highest adsorption capacities were obtained by the inorganic solid supports. Because the impregnation method can affect the properties and the application of the SILs, 4 different methods of impregnations were studied: dry method, stirring method, the wet impregnation method and a new method, ultrasound method. The most efficient methods of impregnation proved to be ultrasound method. Compared with other adsorbents Florisil and Silica impregnated with Cyphos L-101 developed good efficiency in the adsorption process of Cs and Sr.

## Applicability and transferability of the results

The project topic is answering a well-defined problem/question with practical relevance – in the waters depollution with radionuclides content. All results were validated by publication in scientific journals and presentation at scientific conferences.

Adsorbent	$q_m$ , mg/g
Nano-zirconium vanadate	9.1
Resorcinol-formaldehyde RF	5.56
Ceiling tiles	0.2128
Vermiculite	0.646
Florisil impregnated with Cyphos IL-101	3.086
Silica impregnated with Cyphos IL-101	1.48

## Research centre

Research Centre for Environmental Science and Engineering

## Financed through/by

UEFISCDI/Human Resources – Research projects to stimulate the establishment of young independent research – TE

## Research team

Asist. Dr. Eng. Lavinia Lupa – director;  
Prof. Dr. Eng. Petru Negrea;  
Lecturer Dr. Eng. Adina Negrea;  
Scientific Researcher Dr. Eng. Mihaela Ciopec;  
Asist. Dr. Eng. Raluca Voda;  
Eng. Alexandra Bogin.

## Contact information

Assist. Lavinia LUPA, PhD  
Applied Chemistry and Engineering of Inorganic Compounds and Environmental,  
Address: Bd. Vasile Pârvan, No. 6, RO300223, Timisoara  
E-mail: [lavinia.lupa@upt.ro](mailto:lavinia.lupa@upt.ro)

## NEW FABRICATION CONCEPT OF SILVER NANOWIRE/POLYANILINE TRANSPARENT, CONDUCTIVE AND FLEXIBLE ELECTRODES FOR SOLAR CELLS

### Goal of the project

The aim of the project is to develop transparent, conductive and flexible electrodes for solar cells based on silver nanowire/polyaniline hybrid materials and to offer a new technical solution to decrease the sheet resistance of the silver nanowires embedded in the polymer matrix. Low melting point metallic nanoparticles (In and Sn) will be deposited on the surface of silver nanowires, allowing to weld the nanowires and to obtain a network with high electrical conduction paths.

### Short description of the project

A great challenge in the actual research of solar-to-electricity conversion is the construction of flexible solar cells. Although indium tin oxide (ITO) deposited on plastic is traditionally used for organic solar cells and light emitting diodes, solutions are searched to replace the ITO layer and to manufacture cheap transparent conducting electrodes.

Silver nanowires (AgNWs) are a promising candidate to replace ITO due to their high electric conductivity and corrosion resistance, but there is still the issue of increased resistance on wire contacts. The proposed solution involves the modification of the AgNWs by deposition on their surface of metallic nanoparticles with low melting temperatures like tin and indium or their alloys. The modified nanowires will be suspended in a proper medium to form an electroconductive ink that will be deposited on polymeric sheets. The nanowires will be welded by thermal treatment, with and without the application of static pressure.

### Project implemented by

Politehnica University of Timisoara  
Department of Applied Chemistry and Inorganic Compounds and Environmental Engineering

### Implementation period

02.09.2013–30.11.2015

### Main activities

Research activities:

- Synthesis and characterization of silver nanowires with controlled aspect ratio.
- Synthesis and characterization of tin and indium nanoparticles.
- Preparation of silver nanowires modified with tin and indium nanoparticles (mAgNWs).
- Preparation of electroconductive inks based on mAgNWs.
- Manufacturing of mAgNW-based flexible, transparent and conducting electrodes by coating the ink on polymeric substrate

- Optimization of transparent electrodes in order to increase the transmittance / sheet resistivity ratio.
- Deposition of a conducting polymer on previously manufactured electrodes and their use in the construction of dye-sensitized solar cells.
- Electrical characterization of solar cells (ISC, VOC, fill factor, efficiency).

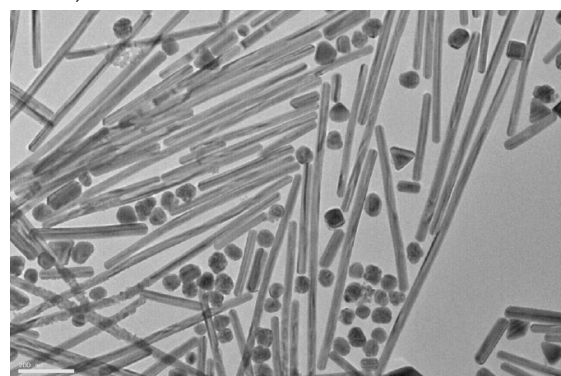

### Results

- Samples of silver nanowires synthesized by the “polyol” liquid phase method.
- Optimization of synthesis conditions to obtain a high ratio of silver nanowires.
- Morphology and structure characterization of silver nanowires by SEM, TEM and XRD

Papers presented at international conferences

R. Banica, R. Baies, R. Bucur, C. Locovei, A. Kellenberger, T. Nyari, Study of liquid phase synthesis of silver nanowires for solar cell applications, 3rd European Energy Conference – E2C 2013, October 27–30, 2013 – Budapest, Hungary.

R. Banica, R. Baies, D. Ursu, M. Poienar, T. Nyari, Silver nanowires synthesis in the PVP-silver-chloride system, ECO IMPULS 2013, November 7–8, Timisoara, Romania.

Estimated results: 3 scientific papers published in ISI ranked journals, one patent application.

## Applicability and transferability of the results

The manufacture of electroconductive inks based on silver nanowires covered with metal nanoparticles with low melting points is expected to have wide technological applications and an important economic impact. This type of conductive inks may be used not only for flexible solar cells but also for other optoelectronic devices, such as flexible LEDs, organic thin film transistors, organic lasers and photo detectors, electronic paper, disposable sensors, low-cost smart cards and RF identification tags, or flexible arrays of plastic microphones.

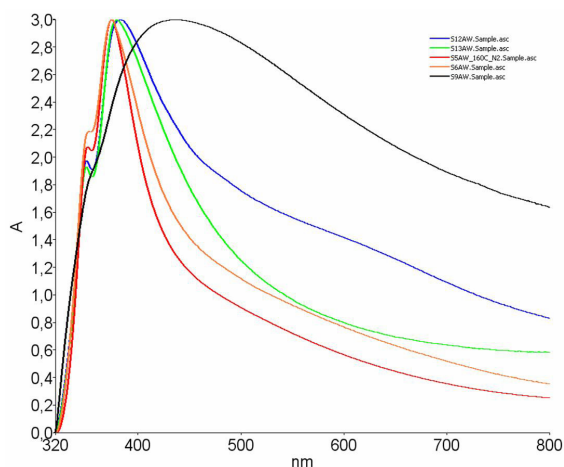

## Fields of interest

silver nanowires, flexible solar cell, transparent conductive electrodes.

## Research centre

Research Centre for Environmental Science and Engineering

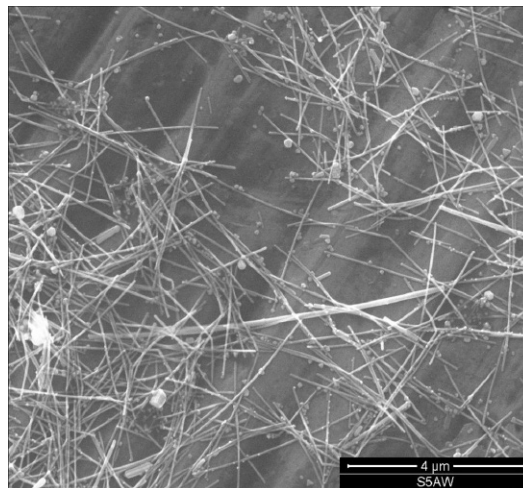
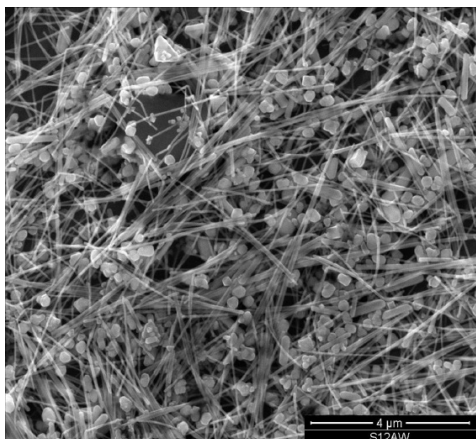

## Financed through/by

UEFISCDI, Executive Agency for Higher Education, Research, Development and Innovation Funding, Programme IDEAS, Exploratory Research Projects.

## Research team

Andrea Kellenberger - project manager  
 Terezia Nyari - senior researcher  
 Cseh Liliana - senior researcher  
 Radu Nicolae Banica - postdoctoral researcher  
 Cosmin Locovei - postdoctoral researcher  
 Radu Baies - postdoctoral researcher  
 Mircea Laurentiu Dan - PhD student  
 Alin Bucur - PhD student  
 Daniel Horatiu Ursu - PhD student  
 Paul Cristian Capota - master student

## Contact information

Assoc. Prof. Andrea KELLENBERGER, PhD  
 Faculty of Industrial Chemistry and Environmental Engineering  
 Address: Bd. Vasile Pârvan, No. 6, RO300223, Timisoara  
 Phone: (+40) 256 404 178  
 Fax (+40) 256 403 060  
 E-mail: andrea.kellenberger@upt.ro  
 Web: [http://www.chim.upt.ro/Facultatea-de-Chimie-Industrialasi-Ingineria-Mediului\\_PN-II-ID-PCE-2012-4-0398\\_qMI.html](http://www.chim.upt.ro/Facultatea-de-Chimie-Industrialasi-Ingineria-Mediului_PN-II-ID-PCE-2012-4-0398_qMI.html)

## NANO-ENHANCED ELECTROCHEMICAL GREEN TECHNOLOGY FOR ADVANCED INTEGRATED WATER TREATMENT AND QUALITY CONTROL

### Goal of the project

The main goal of the project is to develop the electrochemistry application field in water treatment and quality control, by creating the right framework for achieving the high research level.

This project aims to explore potential use of nano-enhanced electrochemical dual green technology to improve access to clean water.

### Short description of the project

Based on the results obtained in our previous studies for the oxidation of pollutants in aqueous solutions for their degradation and/or their detection on the carbon-based electrodes, specific objectives have been set in this project:

1. Elaboration and manufacturing of some new electrodes types based on nanostructured carbon and Ag/Cu/TiO<sub>2</sub> modified zeolite with enhanced electro(photo)-catalytic activity;
2. Manufacturing, design and geometry conditions of electrodes for degradation and monitoring applications;
3. Setting-up the optimal conditions for the degradation and mineralization of priority organic pollutants (POPs) from water;
4. Elaboration of the electrochemical detection scheme;
5. Integration of the electrochemical detection methods within the control of the degradation and mineralization of POPs in aqueous solutions.
6. Development of a new nano-enhanced electrochemical green dual technology for integrated water treatment and control.

### Project implemented by

UEFISCDI

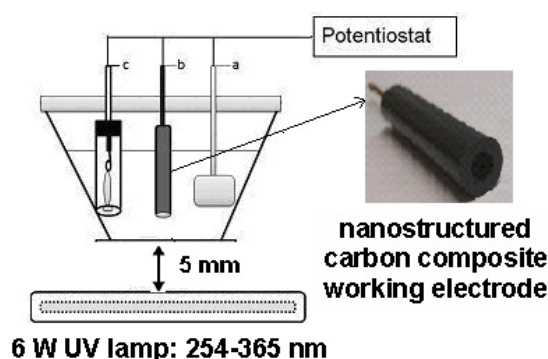
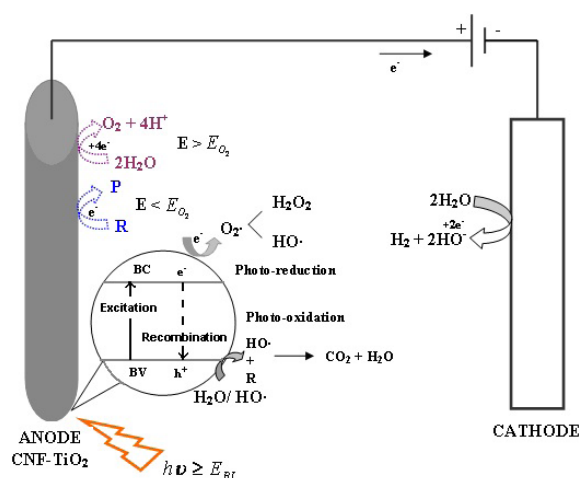

### Main activities

1. Elaboration of new composite materials based on carbon nanotubes (CNT)/carbon nanofibres (CNF) in epoxy matrix as electrode materials for oxidation of POPs from water;
2. Characterization of new composite materials based on CNT/CNF in epoxy matrix and electrode design;
3. Composite electrode obtaining and selection for application in degradation and/or detection of POPs from water;
4. Assessment of electro(photo)catalytic performance of the selected electrodes in advanced degradation/mineralization of POPs;
5. Assessment of the electroanalytical performance of the electrode in detection of POPs from water. Optimization of the electroanalytical method;
6. Integration and optimization of the electrode materials and electrochemical techniques in water treatment and process control.

### Implementation period

01.10.2011 - 19.09.2014

### Research centre

Research Centre for Environmental Science and Engineering



## Results

1. Application of the new electrodes in advanced water treatment process;
  2. Preconcentration / detection scheme based on adsorbent features of CNT/CNF and zeolite for the POPs detection at trace levels;
  3. Procedure for the electroanalytical detection of POPs from water;
- Published papers.

## Applicability and transferability of the results

The nano-enhanced electrochemical green dual technology which will be elaborated at the end of this project could be scaled and tested for application at pilot level in water treatment.

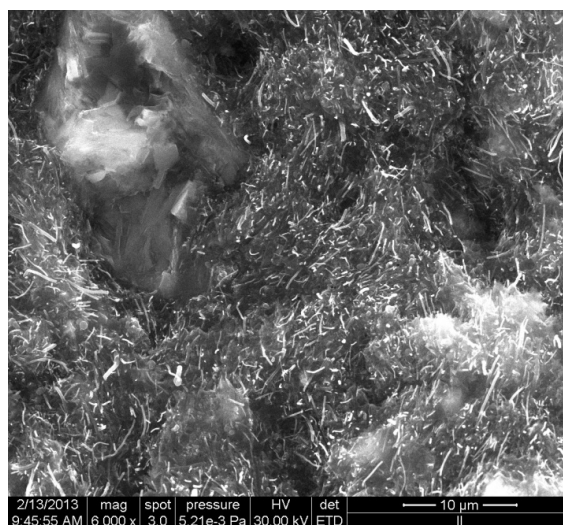
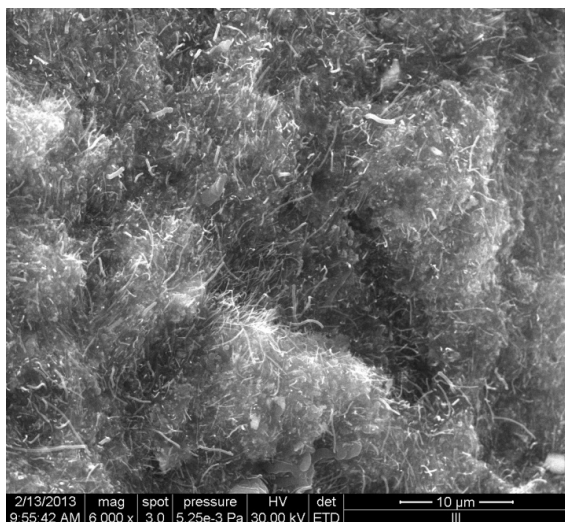

## Financed through/by

UEFISCDI

## Research team

Florica Manea – director  
Rodica Pode – senior researcher  
Aniela Pop – researcher  
Anamaria Baciu – researcher assistant  
Sorina Motoc – researcher assistant

## Contact information

Assoc. Prof. Florica MANEA, PhD  
Department of Applied Chemistry and Engineering of Inorganic  
Compounds and Environmental  
Address: Bd. Vasile Pârvan, No. 6, RO300223, Timisoara  
Phone: (+40) 256 403 070  
E-mail: florica.manea@upt.ro  
Web: <http://www.3waves.ro/id165upt/>

## INTEGRATED SYSTEM FOR REDUCING ENVIRONMENTAL AND HUMAN-RELATED IMPACTS AND RISKS IN THE WATER USE CYCLE

### Goal of the project

The main goal of the project is to develop and implement an integrated system of innovative technologies and management instruments for reducing environmental impacts and associated human health risks caused by water quality aspects in the entire water use cycle: water abstraction, treatment, distribution, use, wastewater collection, wastewater treatment and discharge and reuse.

### Short description of the project

The specific objectives were defined at the level of whole water usage cycle:

1. Development of specific instruments for the identification, quantification and control of environmental impacts and risks, over the water use cycle, applied to regional water operators;
2. Development of the capacity of collaboration and knowledge transfer between the universities and the regional water operators in Iasi and Timis counties for the control of the environmental impacts and human health risks in the water use cycle;
3. Development of the research and institutional capacities of the universities and water regional operators in Iasi and Timis counties for facilitation of the further cooperation at national and international scale;
4. Development of capacities and competitiveness of Romanian researchers and staff of regional water operator, as well as of the national partnerships contributing to environmental sustainability.

### Main activities

1. Integrated evaluation of the water use cycle;
  2. Studies on impact and risk minimization through innovative water treatment process (removal of nitrate, nitrite and natural organic matter);
  3. Studies on impact and risk minimization through innovative wastewater treatment processes (removal of priority organic pollutants);
  4. Pilot-scale studies on impact and risk minimization in water and wastewater treatment for reuse.
- Development of an integrated monitoring system for water-related impacts and risks survey;
6. Development and testing of integrated management instruments for impact and risk prediction and minimization over the water use cycle;
  7. Integration and optimization of the electrode materials and electrochemical techniques in water treatment and control.

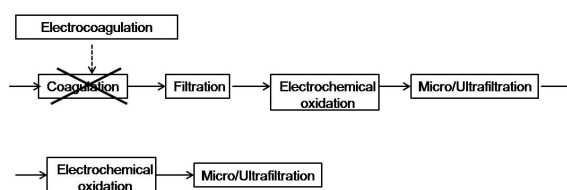

### Project implemented by

- SC Aquatim SA Timisoara
- SC Apavital SA Iasi

### Implementation period

2012 – 2015

### Results

1. Assessment of electrocoagulation, electrooxidation and electroreduction processes in drinking water treatment;
2. Elaboration of an adapted electrocoagulation protocol for advanced treatment of drinking water;
3. Comparative technical-economical assessment of electrochemical process;
4. Integration of electrochemical processes within drinking water treatment flow.

### Financed through/by

UEFISCDI

## Applicability and transferability of the results

Two regional water operators, i.e. Aquatim and Apavital are involved in this project in order to test and apply innovative technologies for water and wastewater treatment in direct relation with specific water quality problems.

## Research centre

Research Centre for Environmental Science and Engineering

## Research team

- Florica Manea-partner responsible
- Rodica Pode-senior researcher
- Laura Cocheci-researcher
- Aniela Pop-researcher
- Anamaria Baciu-researcher as.
- Sorina Motoc-researcher as.
- Magdalena Ardelean-researcher as.
- Agnes Jakob-researcher as.

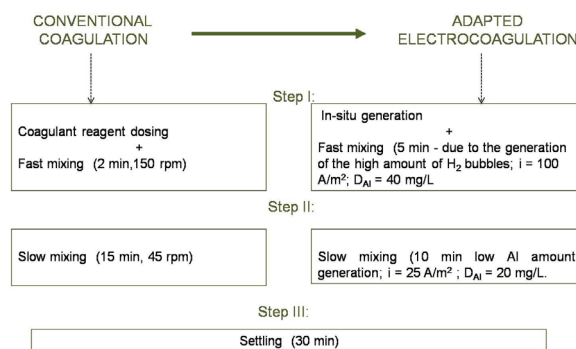

## Contact information

Assoc. Prof. Florica MANEA, PhD  
 Department of Applied Chemistry and Engineering of Inorganic Compounds and Environmental  
 Address: Bd. Vasile Pârvan, No. 6, RO300223, Timisoara  
 Phone: (+40) 256 403 070  
 E-mail: florica.manea@upt.ro  
 Web: <http://www.ch.tuiasi.ro/cercetare/parteneriate/watuser/Home.htm>



## HYDROGEN PRODUCTION FROM BLACK SEA WATER BY SULFIDE-DRIVEN FUEL CELL (HYSUFCEL)

### Goal of the project

The present proposal is directed to the simultaneous goals: first, remediation of the severe environmental situation in the Black Sea, to produce "carbon-free" energy in the form of hydrogen and to extract valuable compounds from the deep marine water. It is based on the opportunity to recover energy from the hydrogen sulfide in the Black Sea. The thermodynamic analysis shows that the energy recovery of the latter is an energy alternative to the natural gas used in the coastal countries.

### Short description of the project

The proposed technology will consist of the following steps: pumping of the water from depths where the sulfide concentration is relatively high; enrichment of the pumped water to attain higher concentrations of sulfide and to enhance the next step: generation of electromotive force in a new designed fuel cell operating by catalytic sulfate oxidation by oxygen; sufficiently high and required for the very hydrogen production by electrolysis. Here other processes for water splitting, alternative to electrolysis will be tested too and the final decision on this step of the technology will be made after the comparison of their feasibility. The final step is hydrogen storage or its utilization as a complementary energy source for electrolysis, used in another traditional fuel cell.

### Project implemented by

Laboratory of Electrochemistry, Corrosion and Electrochemical Engineering, Institute for Renewable Energy, University Politehnica of Timișoara – Romania

### Implementation period

2011 - 2014

### Main activities

2011

1. Technology for hydrogen production.
2. A method for hydrogen storage.
3. Data on the hydrogen clearance overpotential based using solutions of sodium chloride, similar in ionic strength waters in the Black Sea
4. Materials selected to produce the electrodes.

2012

1. Information on the composition of the Black Sea waters.
2. Relations for the determination of kinetic parameters of hydrogen evolution reaction.
3. A method for enhancing the hydrogen evolution reaction.
4. Information on the influence of hydrogen sulfide / sulphide on the catalytic activity of the electrodes and membranes used in fuel cells.
5. A process for extraction of metals from dilute solutions.

6. Hydrogen sulfide / sulphide sensor for usage in sea water and gaseous media.

2013

1. Calculation based on experimental values of energy efficiency for hydrogen production by electrolysis of water containing hydrogen sulfide / sulphide.
2. Electrode material selection.
3. Fuel cell design.
4. Hydrogen storage method suitable for conditions in the Black Sea waters.
5. Design of hydrogen storage system.

2014

Pilot plant.

### Results

1. Technology for hydrogen production.
2. A method for hydrogen storage.
3. Data on the hydrogen clearance overpotential based using solutions of sodium chloride, similar in ionic strength waters in the Black Sea
4. Materials selected to produce the electrodes.
6. Information on the composition of the Black Sea waters.
7. Relations for the determination of kinetic parameters of hydrogen evolution reaction.
8. A method for enhancing the hydrogen evolution reaction.
9. Information on the influence of hydrogen sulfide / sulphide on the catalytic activity of the electrodes and membranes used in fuel cells.
10. A process for extraction of metals from dilute solutions.
11. Hydrogen sulfide / sulphide sensor for usage in sea water and gaseous media.
12. Calculation based on experimental values of energy efficiency for hydrogen production by electrolysis of water containing hydrogen sulfide / sulphide.
13. Electrode material selection.
14. Fuel cell design.
15. Hydrogen storage method suitable for conditions in the Black Sea waters.
16. Design of hydrogen storage system.
17. Pilot plant - in progress

## **Applicability and transferability of the results**

Developed technology will be included in a pilot plant used during a cruise in the Black Sea.

## **Financed through/by**

UEFISCDI, UE

## **Research centre**

Research Centre for Environmental Science and Engineering.

## **Research team**

Prof. Dr. Eng. Nicolae Vaszilcsin  
Prof.Dr.eng. Viorel-Aurel Şerban  
Assoc.Prof.dr.eng. Andrea Kellenberger  
Assoc.Prof.dr.eng. Aurel Răduţă  
Assoc.Prof.dr.eng. Florica Manea  
Assoc.Prof.dr.eng. Mircea Nicoară  
Assist.Prof.dr. Narcis Duţeanu

## **Contact information**

Prof. Nicolae VASZILCSIN, PhD  
Faculty of Industrial Chemistry and Environmental Engineering  
Address: Bd. Vasile Pârvan, No. 6, RO300223, Timisoara  
Phone: (+40) 256 404 180  
Fax: (+40) 256 403 060  
E-mail: nicolae.vaszilcsin@upt.ro

## STUDY OF THE INTERACTION OF TOXIC CONSTITUENTS WITH BIOMOLECULES TOWARDS APPLICATION IN ENVIRONMENTAL ANALYSIS

### Goal of the project

The main objective of the project were:

- Construction and characterization of models that forward the development of analytical tools for the detection of environmental contaminants;
- Development and characterization of bioinspired oligopeptides for efficient and specific binding of toxic metal ions;
- Systematic analytical chemical description of the model systems to assist the targeted modification of ligands for better efficiency and selectivity.

### Short description of the project

Inspired by the metal ion binding domains of metalloregulatory proteins a cross-border project was initiated aiming at the design and synthesis of short oligopeptides for efficient and selective binding of toxic constituents e.g. Hg(II), Cd(II) or As(III). Equilibrium and solution structural studies on the peptide – metal ion interactions, and the ability of the immobilized molecules in capturing toxic ions from aqueous solutions and from environmental matrices was investigated.

### Project implemented by

The project was implemented by the close collaboration between the two partners, "University from Szeged" and Politehnica University of Timisoara.

### Implementation period

01.02.2012 – 31.08.2013

### Main activities

The main activities were:

- Biomolecules design and synthesis;
- Study of the interactions of biomolecules with metals ions;
- Evaluation of the analytical potential of biomolecules for metal ions capture.

### Results

- The design of ligands capable for the efficient binding of toxic metallic contaminants has been taken from the metal binding domain of metalloregulatory MerR family member proteins;
- The immobilization of biomolecules onto solid surfaces;
- The use of immobilized biomolecules for the extraction of metal ions from aqueous solutions and from samples collected from Mures River;

### Applicability and transferability of the results

The project promoted directly or indirectly the development of the following scientific and educational topics and implementation of novel technologies: a) the development of novel water treatment technologies; b) the development of novel biosensors or bioanalytical detection kits applicable in the field to assess/compliance test of heavy metal concentrations in various aqueous solutions;

### Research Centre

Research Centre for Environmental Science and Engineering

### Financed through/by

Hungary-Romania Cross-Border Co-operation Programme 2007-2013

### Research team

Leader Team University from Szeged: Gábor Galbács; Béla Gyurcsik; Attila Jancsó; Zoltán Galbács; Hajnalka Szokolai; Magdolna Juhász; Eva Mózsik.

Partner Team Politehnica University Timisoara: Negrea Petru; Miclea Florian; Muntean Cornelia; Peter Francisc; Negrea Adina; Lupa Lavinia; Ciopec Mihaela; Manea Florica; Moșoarcă Giannin; Paul Cristina; Fițigău Firuța; Ungureanu Mihaela

### Contact information

Prof. Petru NEGREA, Ph. D.  
Department of Applied Chemistry and Engineering of Inorganic Compounds and Environmental  
Address: Str. Carol Telbisz, No. 6, RO300001, Timisoara  
Phone: (+40) 256 404 191 / (+40) 256 403 077  
E-mail: petru.negrea@upt.ro

## CONSULTING SERVICES FOR INNOVATION AND TECHNOLOGICAL EXPERTISE FOR ULTRASONIC ACTIVATED INJECTION MOULDS

### Goal of the project

In a first stage of the project POS-CCE nr. 439/14.01.2013, Politehnica University Timisoara participated as partner (contract no. BC 19 /20.02.2013) of S.C. Nano Inteliform srl Timisoara for the industrial implementation of a new design concept, with ultrasonic activation of an injection mould, for the manufacturing of the thin wall and small parts formed by injection from thermoplastic polymers.

### Short description of the project

As revealed for extrusion, the flow of the melted polymer, under pressure, through the extrusion head is ameliorated due to a synergy between the thermal and the surface effect.

Looking at this possibility, of an improved polymer flow through the mould as consequence of applied vibration, it would be presumed that using ultrasonic energy into an injection mould may :

- reduce the energy requirement in melt processing
- reduce the boundary of the product wall thickness

Two mould configurations with ultrasonic activation (patent applications CBI 00793/2006 and CBI 00792/2006) have been ceded to Nano Inteliform for industrial implementation.

### Main activities

- Evaluation of the application opportunities of the ultrasonic activation for the injection moulds.
- Case studies: Technical solutions of the transferred patent applications v. other patents on the theme.
- Design concept of the experimental mould with ultrasonic activation. Technological configuration restrictions.
- DoE and in-situ research.
- Analysis and interpretation of experimental results.

Conclusions for the design of the prototype mould and for optimal parameters settings.

### Results

- Industrial implementation of a new design concept for injection moulds, with ultrasonic activation, proposed by the UPT research team in two patent applications
- Improvement of the basic knowledge, technical expertise and design skills of the team in the field of industrial ultrasonic applications.
- Improvement of the technological capabilities and performances of the classic injection moulds and of the parts quality, especially for small and thin wall thermoplastic components

### Research Centre

Research Centre for Integrated Engineering

### Applicability and transferability of the results

For injection moulds providers, as design concept and an innovative technical solution for improving the performances of the forming devices, transferable within the framework established by the contract with ANCS and by the IP specifications of POS-CCE grant program.

### Project implemented by

S.C. Nano Inteliform srl Timisoara, Calea Mosnitei, nr. 21, Timisoara

### Implementation period

February 2013 – October 2013

### Financed through/by

MEdCI-ANCS, contract de finantare POS-CCE nr. 439/14.01.2013, cod SMIS-CSNR: 41361

### Fields of interest

Manufacturing of the small and thin wall thermoplastic components in various industrial branches: home appliance, automotive, electronics, domestic goods e.a.:

- increase productivity and quality of the above mentioned products;
- decrease the manufacturing costs.

### Research team

Daniel Stan, Aurel Tulcan, Cristian Cosma, Adrian Dume, Liliana Tulcan, Cristian Turc, Andrei Adam



### Contact information

Assoc. Prof. Daniel STAN, PhD  
Department of Materials and Manufacturing Engineering  
Address: Bd. Mihai Viteazu, No.1, RO300222, Timisoara  
Phone: (+40) 256 403 611  
E-mail: daniel.stan@upt.ro  
Miomir Perita Vlascici  
S.C. Nano Inteliform  
Calea Mosnitei, nr. 21, Timisoara, mv@inteliform.ro

## INNOVATIVE SOLUTIONS IN THE FIELD OF LARGE SURFACE AREA CERAMIC NANOPOWDER PREPARATION VIA COMBUSTION SYNTHESIS

### Goal of the project

Preparation of ceramic powders with controlled properties under advantageous conditions using the solution combustion synthesis: BaAl<sub>2</sub>O<sub>4</sub>, Al<sub>2</sub>TiO<sub>5</sub>, ZrAl<sub>2</sub>O<sub>4</sub>, LaAlO<sub>3</sub> or YAlO<sub>3</sub>. The project proposes several innovative solutions, which will optimize the combustion method, thus allowing the preparation of nanocrystalline compounds of practical interest, with large surface area. The project is expected to have a high impact and lead to remarkable scientific and economical results.

### Short description of the project

The project approaches the preparation of some ceramic powders, which currently develop high economical interest for a number of applications: BaAl<sub>2</sub>O<sub>4</sub>, Al<sub>2</sub>TiO<sub>5</sub>, ZrAl<sub>2</sub>O<sub>4</sub>, LaAlO<sub>3</sub> or YAlO<sub>3</sub>. With a view to obtain the designed powders with tailored properties (as for example crystalline nanopowders with large surface area) in the most advantageous conditions directly from the reactions, with no supplementary conditioning being needed, solution combustion synthesis route is being explored and improved according to the specific of each reaction product. The obtained results are disseminated and confirmed at the same time within the scientific community by communications made during international conferences from the country and abroad, as well as articles published in ISI-ranked journals. At the same time, some results represent the basis of a patent proposal. Project funding is also used for acquiring laboratory equipments to support the research work developed by the implementation team.

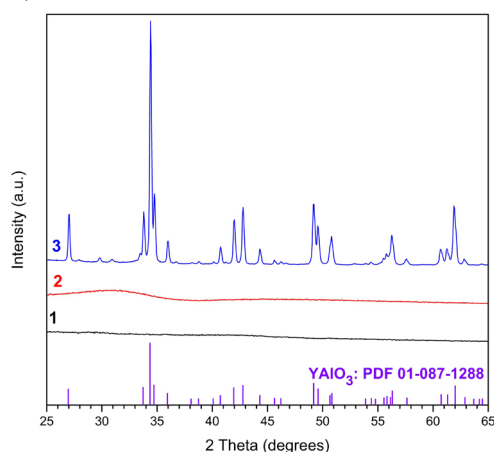

### Project implemented by

Politehnica University of Timișoara.

### Implementation period

01.10.2011 - 30.09.2014

### Main activities

The whole system consisting of radar sensor, sensor fusion, risk assessment and vehicle control has a high potential to be launched in serial cars because the majority of components is already standard equipment in series cars. The additional equipment required should not be a show-stopper from a pure technical point of view.

Measures for VRU protection might be divided into passive and active systems. Because of basic physical properties, passive measures can provide limited protection potential only. Therefore (active) actuators are necessary to achieve the desired protection for VRUs. For example, vehicle deceleration seems to be a potential approach for active VRU protection with high benefit and high potential for high volume series cars, as they are already in use in high-end limousines.

The environmental sensing will be conducted with a novel high performance but low-cost 24 GHz narrowband radar system. From an operational viewpoint, this RF frequency fits exactly into the existing ISM band from 24,000 GHz to 24,250 GHz. Due to this techno-political feature this radar has a long term perspective on European and world-wide markets.

### Results

Two articles published in ISI-ranked journals:

- Chemical oxidation of residual carbon from ZrAl<sub>2</sub>O<sub>4</sub> powders prepared by combustion synthesis, Robert Ianoș, Radu Lazău, Ioan Lazău, Cornelia Păcurariu, Journal of the European Ceramic Society 32(8), July 2012, Pages 1605–1611, Impact Factor: 2.360, Relative Influence Score - 4.076.
  - Nanocrystalline BaAl<sub>2</sub>O<sub>4</sub> powders prepared by aqueous combustion synthesis, Robert Ianoș, Radu Lazău, Roxana Băbuță, Silvana Borcănescu, Cristian Boruntea, Ceramics International, 39(3) April 2013, Pages 2645–2650, Impact Factor: 1.789, Relative Influence Score - 2.688.
- Four papers communicated within international scientific meetings from abroad and four papers communicated within international scientific meetings from the country.

Two literature studies.

## Applicability and transferability of the results

The results achieved within the project may represent the starting point for industrial applications in the synthesis of the approached compounds. Therefore, the results are disseminated and subjected to scientists and technician's attention using large visibility ISI-ranked journals and international conferences, which are representative for the research field. A patent proposal is also in progress. The results may also be transferred to the students as part of their training in the field of micro and nanomaterials, ceramics synthesis and processing or multifunctional intelligent materials.



## Fields of interest

Ceramic nanopowders preparation, solution combustion synthesis, zinc spinel, alkaline earth and rare earth aluminates, tialite, yttrium aluminate, perovskites, phosphor materials.

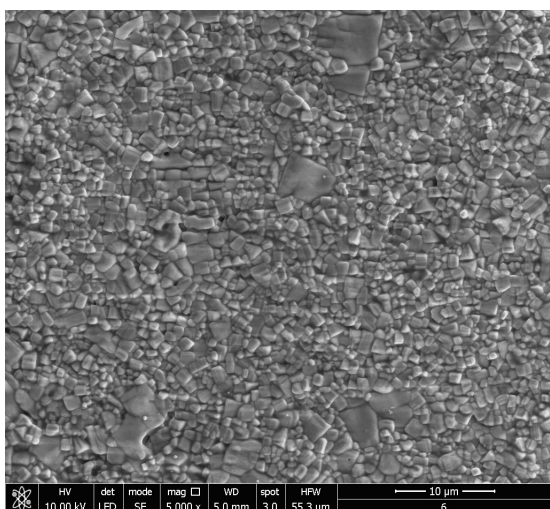

## Research centre

Research Centre for Inorganic Materials and Alternative Energies

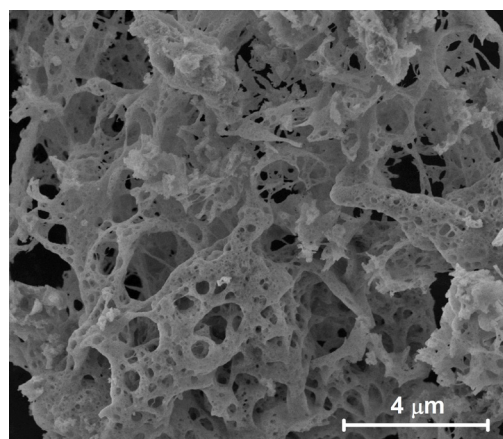

## Financed through/by

The project is financed by the Executive Agency for Higher Education, Research, Development and Innovation Funding UEFISCDI, Human Resources PROGRAMME, Research projects for the stimulation of the funding of young independent research teams (TE). Project ID: PN-II-RU-T E- 2011-3-0024.

## Research team

Ianoș Robert - project leader  
Lazău Radu - researcher  
Borcănescu Silvana - researcher  
Băbuță Roxana - researcher

## Contact information

Assist. Prof. Robert IANOȘ, PhD / Assist. Prof. Eng. Radu LAZAU, PhD  
Faculty of Industrial Chemistry and Environmental Engineering  
Address: P-ta Victoriei, No.2, RO300006, Timisoara,  
Phone: (+40) 256 404 167  
Fax: (+40) 256 403 060  
E-mail: robert.ianos@upt.ro, radu.lazau@upt.ro  
Web: <http://www.upt.ro/pfe10.php>



## TEMPERATURE ASSESSMENT OF A VERTICAL STEEL MEMBER SUBJECTED TO LOCALISED FIRE PROJECT (LocaFi)

### Goal of the project

The main goal of the project is to improve the existing knowledge on the effects of the localized fires in a building compartment. With the actual methodology included in the Eurocodes for the fire design of buildings, it is only possible to assess the temperature of a steel element in the vertical axis of the localised fire. It is impossible to assess the temperature or the flux received by a vertical member at a given distance of the fire source.

### Short description of the project

The project is devoted to the development of an analytical model for the calculation of the temperatures in the vertical structural steel elements of a building, subjected to localised fires.

The new method, developed by means of experimental and numerical research, will provide the fluxes received in any point of a building compartment subjected to a localised fire.

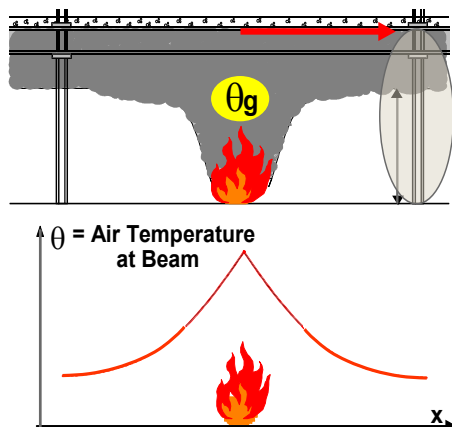

### Project implemented by

- ArcelorMittal Luxembourg (coordinator)
- Centre Technique et Industriel de la Construction Métallique, France
- Politehnica University of Timisoara, Romania
- Universite de Liege, Belgium
- University of Ulster, Ireland

### Main activities

- Collection of the different national annexes and national parameters for the application of the Natural Fire Models in different European countries and implementation of these parameters in a Software;
- Definition and realisation of laboratory tests assessing the effect of the real flame emissivity for element engulfed into the fire;
- Definition and realisation of laboratory tests assessing the fluxes received by an element subjected to localised fire but not engulfed in the fire;
- Development and validation using CFD models of simplified analytical model for the evaluation of the fluxes received by an element in any point of a compartment;
- Implementation of the developed analytical model in a user-friendly tool;
- Redaction of a design guide for the application of the new methodology including design examples.

### Results

Design procedures based on the analytical models developed within the project will be proposed.

### Implementation period

1 July 2012–30 June 2015

## Applicability and transferability of the results

The analytical models developed within the project will be introduced in a user friendly software and in an advanced calculation model for fire design, in order to offer a large utilization of the procedure for the construction market.

## Research team

Associate Professor Raul Zaharia (coordinator for Politehnica University of Timisoara)  
Professor Dan Dubina, C.M. of the Romanian Academy  
Lecturer Dan Pintea

## Research centre

Research Center for Mechanics of Materials and Structural Safety - CEMSIG

## Financed through/by

EUROPEAN COMMISSION  
DIRECTORATE-GENERAL FOR RESEARCH AND INNOVATION  
Research Fund for Coal and Steel - RFCS

## Fields of interest

Design of buildings in fire situation.

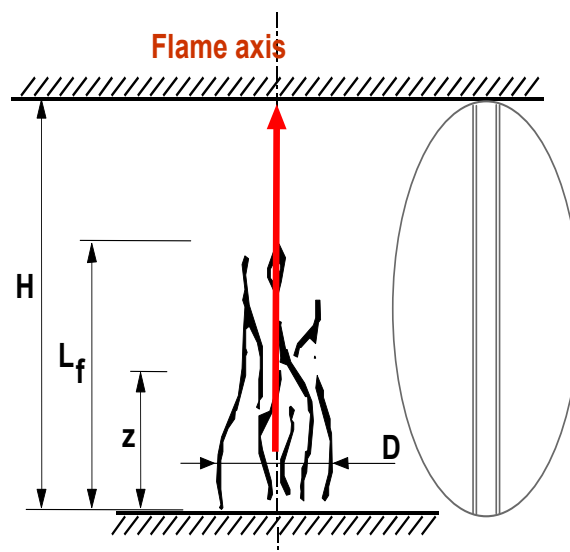

## Contact information

Assoc. Prof. Raul ZAHARIA, PhD  
Department of Steel Structures and Structural Mechanics, Faculty of  
Civil Engineering  
Address: Str. Ioan Curea, No. 1, RO300224. Timisoara  
Phone: (+40) 256 403 922  
E-mail: raul.zaharia@upt.ro



## FULL-SCALE EXPERIMENTAL VALIDATION OF DUAL ECCENTRICALLY BRACED FRAME WITH REMOVABLE LINKS (DUAREM)

### Goal of the project

The proposed research aims at reducing the repair costs and downtime of a structure hit by an earthquake. There are three main objectives: to validate experimentally the recentering capability of dual structures with removable dissipative members, to investigate the interaction between the concrete slab and the steel structure in the link region and to assess global seismic performance of dual EBFs with removable links, including replacement of damaged links.

### Short description of the project

Improved seismic performance of multi-storey structures is to be attained through removable dissipative members and re-centering capability. These two concepts are to be implemented in a dual structure, obtained by combining steel eccentrically braced frames with removable bolted links with moment resisting frames.

The bolted links are intended to provide the energy dissipation capacity and to be easily replaceable, while the more flexible moment resisting frames would provide the necessary re-centering capability to the structure. The columns are to be realised from high strength steel, in order to keep these members in the elastic range even under strong seismic input. The validation of the proposed solution is to be realised through a pseudo-dynamic test of a fullscale model of a dual eccentrically braced structure. The research will demonstrate the feasibility of the proposed concept clearing the route toward implementation into design practice.

### Project implemented by

- CEMSIG - The Research Center for Mechanics of Materials and Structural Safety - Research and Technical
- Development unit of Politehnica University Timisoara, at the Faculty of Civil Engineering, Department of Steel Structures and Structural Mechanics.

### Implementation period

01.06.2010 – end of 2013

### Main activities

- Numerical simulations on the test structure and links were done in order to investigate the possibility to replace bolted links following significant inelastic deformations and the practical feasibility of the replacement procedure;

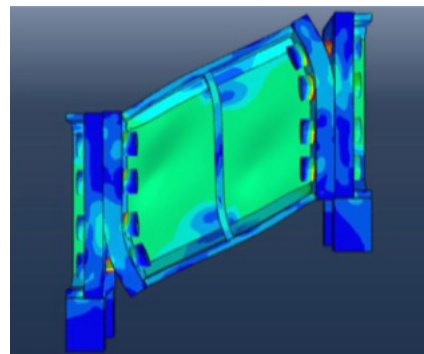

- Practical solutions regarding order in which bolted links need to be replaced were developed;
- A solution that uses temporary braces with viscous dampers mounted on the structure during link removal was analysed and chosen in order that the link removal process to be a safe one;
- Some experimental tests on one-storey one-span frames were used in order to calibrate the numeric model of the DUAREM test structure, before applying the link removal procedure.
- The link replacement order is investigated in a more complex high-rise structure.

### Results

Experimental tests on a one-storey frame concluded that both the web and flanges have to be flame cut and proved the concept to be feasible, while these results were used in order to calibrate an improved numerical model of the eccentrically braced frame with removable links. Numerical simulation of the link removal order showed that there is negligible redistribution of forces among stories.

Therefore, the link replacement procedure can be performed on a story by story basis, starting from the least to the most loaded ones (from the upper story toward the lower one). As a concern of operating personnel safety during the flame cutting of links (possible sudden release of link shear force) there were analysed and adopted temporary bracing and damper system in the moment resisting bays.

## Applicability and transferability of the results

After the pseudo-dynamic experimental validation of the main concepts, the experimental results interpretation and numerical model validation and calibration, the system can be applied to new, higher, multi-storey steel dual structures in seismic areas.

A design methodology for dual eccentrically braced steel frames with removable links thus can be developed, as well as a guide for link replacement technology.

The system may also be extended to buckling restrained braced (BRB) and steel plate shear walls (SPSW) systems.

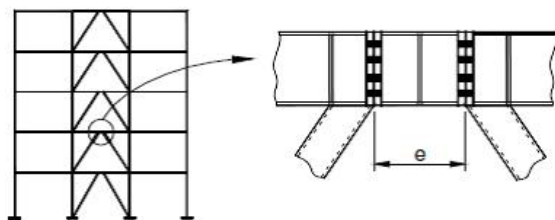

## Fields of interest

- Re-centring structures.
- Performance-based design.
- Bolted link connections.
- Pseudo-dynamic structural experimental tests.

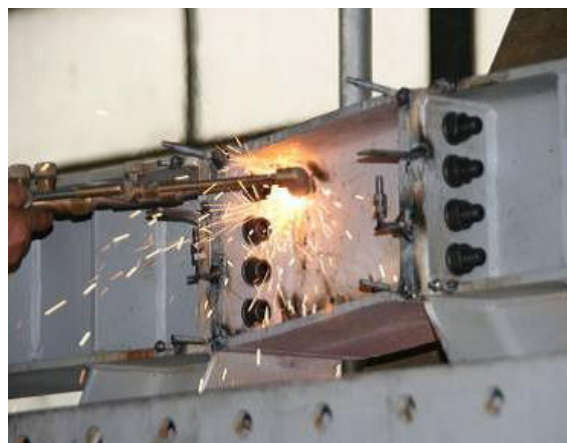

## Research centre

Research Centre for Mechanics of Materials and Structural Safety (CEMSIG)

## Financed through/by

European Community's Seventh Framework Programme [FP7/2007-2013] for access to the European Laboratory for Structural Assessment of the European Commission – JRC under grant agreement n°227887 + European Community's Research Fund for Coal and Steel under grant agreement n°RFSR-CT-2009-00024 "High strength steel in seismic resistant building frames"

## Research team

- Politehnica University Timisoara, Romania (coordinator) – Prof. Dan Dubina, Assoc. Prof. Aurel Stratan, PhD. St. Adriana Ioan
- University of Liege, Belgium – Prof. Jean-Pierre Jaspart
- University of Naples "Federico II" – Faculty of Architecture, Italy – Prof. Raffaele Landolfo
- University of Ljubljana, Slovenia – Prof. Darko Beg
- University of Coimbra, Portugal – Prof. Luis Simoes da Silva

## Contact information

Prof. Dr. H.C. Dan DUBINĂ, PhD  
Corresponding Member of Romanian Academy  
Department of Steel Structures and Structural Mechanics, Faculty of Civil Engineering  
Address: Str. Ioan Curea, No. 1, RO300224, Timisoara  
Phone: (+40) 256 403 920  
E-mail: dan.dubina@upt.ro

## SUSTAINABLE BUILDING PROJECT IN STEEL (SB\_STEEL) RESEARCH FUND FOR COIL AND STEEL PROJECT

### Goal of the project

The project aims at concepts of sustainable steel building both for new-built and renovation, and based on this approach, at a novel decision-making platform that supports selection of steel-intensive solutions in the early phases of a building project. The importance of an improved knowledge basis and also methods for the early phases is highlighted by the fact that framing and typical related technologies are also selected then. The decision-making platform will be made available to various operators of the steel construction sector by The European Convention of Constructional Steelwork – ECCS.

### Short description of the project

The approach of the project to sustainable building is based upon holistic valuing processes that include environmental, economic and social dimensions.

SB\_Steel develops methods and tools that are needed in the early phases of a building project. It is well known that pre-design decisions are crucial for the success of the entire construction project and for the performance and value of the completed building. The project will develop a software that will be available to various stakeholders of the steel construction sector. In order to achieve the goals, the R&D objectives of the project are:

- to build-up a sustainability assessment methodology for a new or renovation building project;
- to develop a multi-criteria assessment method for an early phase of a building project;
- to develop knowledge base for performance-based requirements management;
- to develop a decision-making platform that supports selection of steel-intensive solutions;
- to develop a piloting version of the service concept.

The sustainable building or renovation concept comprises the key indicators by which a building or renovation project can be steered, and later on the overall performance of a completed building can be monitored and evaluated. A hierarchy of performance criteria includes sustainability requirements.

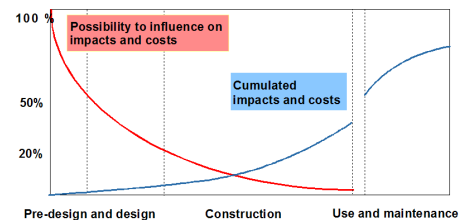
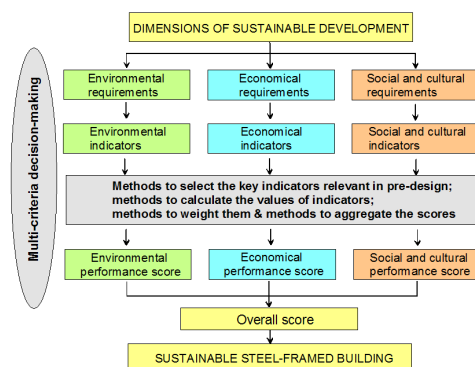

### Project implemented by

VTT Technical Research Centre of Finland.

### Main activities

- Identification of key indicators of sustainable steel-framed building projects;
- Assessment of the overall life-cycle's impacts of steel framed buildings on the sustainable development, special emphasis on energy and material flows;
- Concept development for overall performance issues and their verification methods for a completed building during its whole life cycle (for a new build or renovated building);
- Development of a comprehensive approach to the pre-design and preliminary phases;
- Development of Environmental Software Tool aimed at a quick evaluation, at the pre-design stage, of the sustainability of steel-framed buildings, from the points of view of environmental life-cycle performance and energy efficiency;
- To provide case-studies on three steel-intensive projects in order to apply and validate the LCA-based methodology and the software tool developed.

### Implementation period

01.10.2010 – 30.09.2013

## Results

- Identification of the case-studies; development of a data-bank of all case-studies; reference design of the case studies; localization of the case studies for the various climatic regions;
- Conceptual development of the architecture of the software and flowcharting: assembly of general methodology for environmental and energy assessment of steel framed buildings;
- Implementation of the software. Based on the alternative designs, which are stored in the database, and according to the priorities given by the user to each criterion, the program provides a ranking of the alternative solutions;
- Calibration and validation of the software based on case-studies.

## Applicability and transferability of the results

The early phases of a building project are known to be most crucial for the success of the construction work and for the performance and value of the completed building. The platform is available to various operators of the steel construction sector. The piloting web-based service will be run by the European Convention of Constructional Steelwork.

## Research centre

Research Center for Mechanics of Materials and Structural Safety (CEMSIG)

## Financed through/by

Research Fund for Coal and Steel.

## Research team

VTT Technical Research Centre of Finland (coordinator); Acciona Infraestructuras S.A., Spain; Fundacion Tecnalia, Spain; "Politehnica" University of Timisoara, Romania; Mostostal Warszawa S.A., Poland; University of Coimbra, Portugal; University of Minho, Portugal; Aristotle University of Thessaloniki, Greece; European Convention for Constructional Steelwork ECCS, Belgium; ArcelorMittal, Luxemburg.

## Fields of interest

Sustainability of new and existing steel structures.

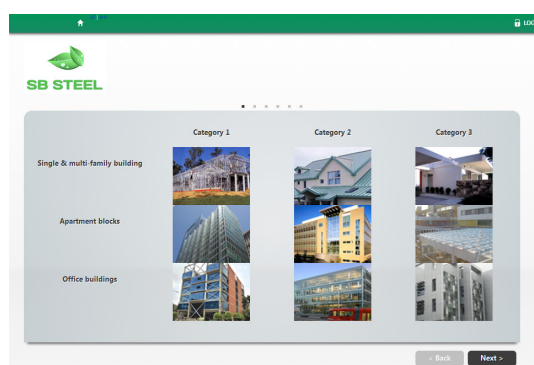

## Contact information

Prof. Viorel UNGUREANU, PhD  
Department of Steel Structures and Structural Mechanics  
Address: str. Ioan Curea, No. 1, RO300224, Timisoara  
Phone: (+40) 256 403 927  
E-mail: viorel.ungureanu@upt.ro

## STABILITY OF STEEL FRAMES MADE OF ELEMENTS WITH VARIABLE SECTIONS: INFLUENCE OF IMPERFECTIONS AND LATERAL RESTRAINTS

### Goal of the project

The objective of the project is to bring to the attention of structural engineers, manufacturers and contractors, the importance of initial imperfections and lateral restraints in the real behavior of the steel frame, in order to obtain well configured and erected steel structures and prevent component elements stability loss, an unacceptable aspect.

### Short description of the project

Steel structures in form of members, plates and shells must frequently be investigated by advanced numerical methods, in order to take into account specific cases of loadings, boundary conditions, geometrical and material imperfections. The aim of the present research program is to find some answers to the following answer: What is more important, the shape or the size of the initial imperfection?

For this purpose parametric studies made by performing computer programs were used. Experimental tests were performed in the CEMSIG laboratory, in order to calibrate numerical models. The obtained results will be thereafter compared with the analytical ones, following the design methods/specifications of SR-EN1993-1-1.

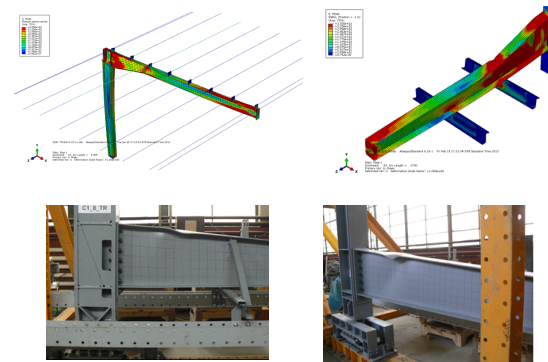
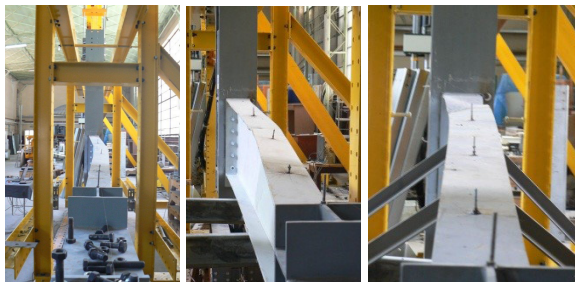

### Applicability and transferability of the results

The results obtained during the project emphasize in a more realistic manner the behavior of tapered elements, made of plated steel, when lateral restraints and initial imperfections apply. Besides this the actual design (not covered very clear by the codes) of these types of elements can be made accounting for all external influences and boundary conditions.

### Main activities

Imperfection influence study on isolated members with variable cross section (beams, columns) under combined bending and compression. The influence of different type lateral restraining on the element behavior - variable cross-section columns.

Imperfection influence study on single storey steel frames with slender elements under gravitational loading (permanent, technological and snow load) and extreme horizontal loading. Experimental testing of laterally restrained single storey steel frames. Calibration and parametrical study on the behavior of steel frames with elements of variable cross section.

### Project implemented by

CEMSIG research Center, Department of Steel Structures and Structural Mechanics, Politehnica University of Timisoara.

### Implementation period

01.09.2010-31.07.2013



## Results

The out-of-plane buckling of the frame elements was noticed to be the main failure mode indifferent of the applied lateral restraints. There were cases for which the global lateral-torsional buckling of the frames was coupled with local buckling of the web. This was mainly observed when the restraints applied on the frame element are more effective against overall buckling (e.g. type 3 restraints). It was noticed that the considered imperfections has a low to significant influence on the final capacity of the frame, function of the applied lateral restraints. The difference between considered imperfections is significant mainly for the combined cases. The difference between elastic (actual) and rigid lateral restraints increases by the span increasing, a maximum 10 % difference was recorded.

In what concerns the seismic behavior, even though the obtained behavior factor for type 1 and 2 lateral restraints characterizes the frames as low dissipative, this value can be improved significantly if more effective lateral restraints are applied.

The finite element modeling is reliable in predicting the ultimate capacity of the elements with tapered web under both compression and bending with sufficient accuracy.

From the experimental results - the restraining contribution from the purlins alone is reduced (their effect is small) for all specimen series. This might be explained by the small influence of the axial compressive force on the behaviour of beam-column elements with variable cross sections. The cross section twists rather than buckles laterally, due to the distribution of the normal stresses on the height of the cross section. The ultimate capacity can be improved by applying a supplementary restraining at the compressed flange, but this is only possible with the use of thicker web element (i.e.  $t=8\text{mm}$ ).

## Research centre

The Research Center for Mechanics of Materials and Structural Safety - CEMSIG

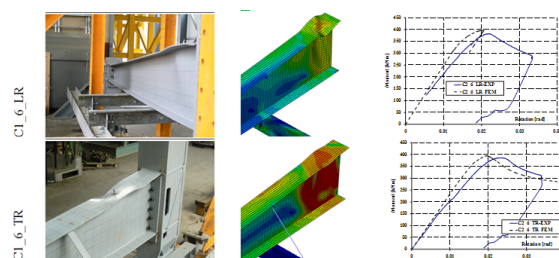

## Fields of interest

The main field of interest, connected with the aim of the project, could be considered as follows: the stability and ductility of steel structures, design of steel structures, behavior of steel structures under extreme loadings, behavior of thin walled structured made of plated elements, reliability analysis of steel structures

## Financed through/by

Ministry of Education, Research and Innovation. The National Authority for Science Research

## Research team

Phd. Eng, Senior Lecturer Mircea Cristuțiu  
 Phd. Eng, Senior Lecturer Adrian Dogariu  
 Eng, Research assistant, Daniel Nunes  
 Phd. Eng, Assitant, Sorin Bordea

## Contact information

Assist. Prof. Mircea CRISTUȚIU, PhD  
 Faculty of Architecture  
 Address: Str. Traian. Lalescu, No 2. , RO300223 Timisoara  
 Fax: (+40) 361 814 159  
 Mobile: (+40) 723 281 859  
 E-mail: mircea.cristutiu@upt.ro  
 Web: www.arh.upt.ro

## NEARLY ZERO ENERGY BUILDING AND PASSIVE HOUSE – SUSTAINABLE SOLUTIONS FOR RESIDENTIAL BUILDINGS

### Goal of the project

The main activities of the NEZ EBUILD research project are related to the design and detailing of technical solutions in order to achieve the nearly zero energy building standard. Further, the main goal of the project is to validate the selected solutions through extensive monitoring. Design and execution refer to construction elements, finishes and installations system.

### Short description of the project

In Dumbravita (near Timisoara), a residential building was built as a duplex. Half of the duplex was conceived and equipped as a passive house (PH) and the other half as a nearly zero energy building (NZ EB). For the construction of the house were used common materials such as reinforced concrete, bricks, wood and polystyrene. Opaque elements of the envelope were insulated with polystyrene plates. By monitoring the house from Dumbravita, the energy consumption is measured and thermal comfort parameters are kept under observation. The monitoring system registers and collects data which is uploaded to a web server. The components of the monitoring system result from the need to make data available online and the physical measurements that had to be taken. Therefore the system contains a central unit and a number of ambient/energy sensors. The PH is being monitored for over a year and relevant conclusions can be drawn regarding energy efficiency of the building and the thermal comfort.



### Project implemented by

Project Partnership comprising Politehnica University of Timisoara - CCI Department and Arhitim.

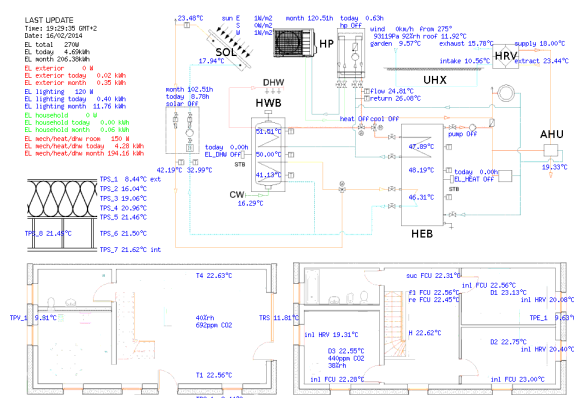

### Main activities

- Design and detailing of NZ EB system including procurement of materials, equipment and elaboration of energy performance certificate for NZ EB.
- Elaboration of research reports and scientific papers.
- Energy performance assessment of the passive house using the recorded data from the monitoring system.
- Execution of finishes for the NZ EB, mounting of HVAC system and procurement of all the other necessary equipment.
- Design of the monitoring system and initiation of the monitoring activities for the NZ EB.
- Elaborating a comparative PH vs. NZ EB study on energy efficiency; optimization of global cost for NZ EB; lifecycle assessment of NZ EB.
- Dissemination of recommendations and general rules for implementing energy efficient residential houses in temperate climate.

### Research centre

Research Centre for Retrofitting of Constructions – RECO

### Implementation period

2012-2015

## Results

Expected final results of the NEZ EBUILD project consist in the elaboration of a recommendation design guide regarding NZ EB systems based on experimental research. Until this point of the project development, the most relevant results consist in:

- validation, verification and centralization of data obtained through the monitoring system installed in the passive house;
- interpretation and analysis of the monitoring data and energy certification based on actual measured energy consumption of PH;
- continuous monitoring of the interior hygrothermal parameters of the building;
- completion of the finishing and equipping works on the NZ EB;
- installation of the monitoring system and initiation of the monitoring for NZ EB.

## Applicability and transferability of the results

The topic of the project is closely related with the increasing concern of nowadays society on reducing the energy consumption in buildings. The targeted groups of the project are scientist, specialists in the energy efficiency field and stakeholders. The project deliverables will assure the transfer of knowledge, generating further „know-how” for scientific community and for practicing specialists (civil and environmental engineers, electrical and energy engineers, architects, technicians).

## Fields of interest

Energy efficiency;  
Nearly Zero Energy Building;  
Passive House;  
Sustainable design of residential houses;  
Environmentally and economically impacts of the energy efficient houses.



## Research team

PROJECT MANAGER:

Prof. PhD. Eng. Daniel DAN

UPT TEAM MEMBERS:

Prof. PhD. Eng. Valeriu ST OIAN

Lecturer PhD. Eng. Tamas NAGY-GYORGY

As. PhD. Eng. Sorin-Codruț FLORUȚ

As. dr. Eng. Cosmin DAESCU

Eng. Simon PESCARI, PhD student

As. dr. Eng. Călin SEBARCHEVICI

ARCHITECT TEAM MEMBERS:

Arh. Dan ST OIAN, PhD student

Eng. Cristina TĂNASĂ, MSc student

Eng. Cristian SABĂU, MSc student

## Financed through/by

This work was supported by a grant of the Romanian National Authority for Scientific Research, CNDS – UEFISCDI, project number PN-II-PT-PCCA-2011-3.2-1214-Contract 74/2012.

## Contact information

Prof. Daniel DAN, PhD

Department of Civil Engineering and Equipments

Address: Str. Traian Lalescu, No. 2, RO300223, Timisoara

Phone: (+40) 256 403 005

E-mail: daniel.dan@upt.ro



## PERFORMANCE ASSESSMENT OF ENERGY EFFICIENT HOUSES THROUGH MONITORING - PASSHOUSE

### Goal of the project

The main goal of the project is to conceive and setup a monitoring system through which all the hydrothermal parameters of a building are to be registered. All the recorded parameters are analysed in order to conclude the efficiency of the system. Another important aspect is to validate or improve energy consumption calculation methods, through real, measured data of energy consumption and to provide cost-benefit calculations for investors, architects, constructors and for private people.

### Short description of the project

In Dumbravita, (near Timisoara) Timis county, a residential building has already been constructed as a double house. Under these circumstances, constant monitoring of hygro-thermal parameters is being carried out. Based on the data provided by the monitoring system, a detailed evaluation of energetic performance shall be carried out.

In respect with the monitored elements, the equipment can be divided into 10 major groups. Naturally, it can be stated that all the important hygro-thermal and climate parameters will be monitored.



### Main activities

- Procurement of monitoring equipment and energy performance certification for PASSHOUSE / research reports / scientific papers.
- Evaluation of energetic performances for the PH using recorded monitoring data, design of the monitoring system, procurement and set-up of equipment and initializing of the monitoring activities.
- Transfer of know-how to interested specialists through workshops and technical meetings.

### Results

Expected results of the project as well as end products go hand-in-hand with the appointed objectives of the project. Thus, the main end products are the deliverables, in the form of detailed guidelines, plans and recommendations that shall be drawn up. Documents which attest the build-up the finishing and installation system and Energy certification of the Passive House building using real energy consumption

Recording the comfort parameters of the PASSHOUSE and report charts of monitored parameters. Monthly Monitoring Data Sheets related to the envelope and to indoor and outdoor conditions. The main results consist of exhaustive knowledge and fathom of PASSHOUSE system. However, during implementation of the project is most probable that the research team will achieve important new findings and will generate patents for some subassemblies.

### Project implemented by

Project partnership comprising of "Politehnica" University of Timisoara - CCI Department and SolarTech South Plain Nonprofit.

### Implementation period

2011-2012

### Research centre

Research Centre for Retrofitting of Constructions

## Applicability and transferability of the results

Knowledge transfer to people about energy-efficient solutions. The target groups of the project are stakeholders who can do something for sustainable energy consumption.

The topic of the project and the issues that it addresses are of great importance not only for Romania and Europe, but for all of the developed countries in the world which can afford to apply measures for enhancement of energy efficiency.

The most important target groups of individuals, to whom the results and end products of the project will be most interesting, is represented by the scientists and specialists working on energy-consumption projects. Another targeted group of the project are stakeholders who can take real actions for sustainable energy consumption by adjusting the way they approach buildings, both new and existing ones.

All issued documents in the shape of deliverables will assure the transfer of knowledge intra- and inter-disciplinary, generating further know-how for scientific community and for practicing specialists. Furthermore, the guidelines would enable and encourage architects and planners to properly consider the optimal combination of improvements in energy efficiency and use of energy from renewable sources when planning, designing, building facilities.



## Financed through/by

Hungary-Romania Cross-Border Co-operation Program 2007-2013 ([www.hurocbc.eu](http://www.hurocbc.eu)) and is part-financed by the European Union through the European Regional Development Fund, Hungary and Romania, Action 2.2.3. Cooperation between sectors involved in R&D, contract id HURO/ 1001/221/2.2.3.

## Fields of interest

Energy efficiency; Health Monitoring; Passive House; Advancement of energy-efficiency of buildings with all aspects of environmentally, economically and socially sustainable construction sector.

## Research team

PROJECT MANAGER: Prof. dr. ing. Valeriu STOIAN

TEAM MEMBERS: Assoc.Prof. dr. ing. Daniel DAN

Sl. dr. ing. Tamas NAGY-GYORGY

As. dr. ing. Sorin-Codrut FLORUT

Dr. Ing. BRATA Silvana

Dr. Ing. DORHOI Sebastian

## Contact information

Prof. Valeriu STOIAN, PhD

Department of Civil Engineering and Equipments

Address: Str. Traian. Lalescu, No 2. , RO300223 Timisoara

Phone: (+40) 256 403952/ (+40) 256 403 958

E-mail: [valeriu.stoian@upt.ro](mailto:valeriu.stoian@upt.ro)

## DIGITAL MECHANISM AND GEAR LIBRARY GOES EUROPEANA

### Goal of the project

The European project thinkMOTION is intended to offer knowledge in the field of mechanisms and machine science through the portal Europeana on a specialized site called DMG-Lib. The content posted on DMG-Lib presents information in more categories: books, articles, proceedings, PhD thesis, contributions, journals, reports, biographies, images, interactive animations, software and so on. One of the main goals of the project is the retrieval of mechanism science in its history.

### Short description of the project

DMG-Lib is a digital library, which provides content originating from universities, libraries, patent offices, individual owners, etc. Almost all content before 1990 exists in analogue form, written, printed or drawn on paper support. Gathering national historical treasures in a well-organized collection requires digitization of a large amount of documents. The processing of an item starting with an analogue document or a physical model and ending up with high-quality digital information pursued the following workflow:

- locating of content providers
- obtaining the rights of use from IPR owners
- performing the primary digitization (fig. 1)
- processing of the raw files (to fulfill the standards imposed by Europeana - fig. 2)
- digitization of images
- generating movies, interactive animations and CAx files inspired by physical models (fig. 3)
- contributing with Romanian scientists' biographies to a Who-is-Who European Collection
- posting the web-compliant items online.

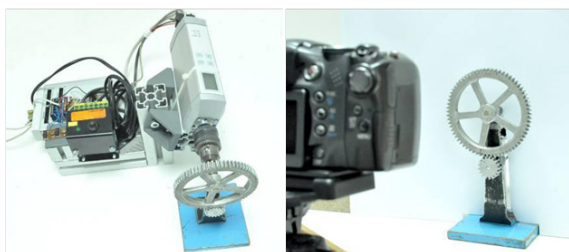

### Project implemented by

- Ilmenau University of Technology (Germany)
- University of Basque Country (Spain)
- Politehnica University of Timisoara (Romania)
- RWTH Aachen (Germany)
- French Institute of Advanced Mechanics (France)
- University of Cassino (Italy)

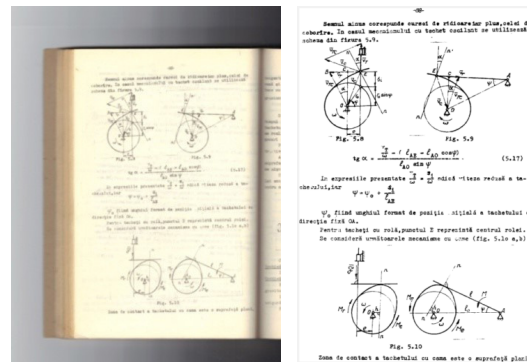

### Main activities

The workpackages within the project are briefly described below:

- WP1: Coordination, project management and quality assurance
- WP2: Adaptation to interfaces to Europeana
- WP3: Locatong and providing relevant sources and clarification of rights of use
- WP4: Digitizing heterogeneous input content
- WP5: Processing of digitized content and integration into DMG-Lib
- WP6: Entering metadata for content
- WP7: Collection and systematization of information about important persons in mechanism science
- WP8: Multilingual translation of metadata
- WP9: Sustainability and exploitation
- WP10: Dissemination, awareness activities and staff development

The partner University Politehnica of Timisoara was leader on workpackage 5

### Implementation period

10.06.2012-31.05.2013

## Results

Several highlights at the end of the project are:

- 71.525 items online in DMG-Lib (115% of the estimated 62.000 Europeana items). The distribution per item type is:
- 26.150 text documents (among which important historical books – fig. 4)
- 33.178 images
- 2.563 mechanism models
- 3.414 movies
- 2.796 animations
- 1.890 CAx files
- 1.534 personas and vitas.

Furthermore, the consortium can state:

- 1076 users/day on DMG-Lib
- 578 newsletter subscribers in 24 countries
- 447 agreements signed for non-public domain content
- 7386 multilingual thesaurus terms in the database
- 6 languages supported by the DMG-Lib portal
- 62 scientific papers published.

The final reviewing performed by the European Commission in September 2013 assessed the project with the mark “Excellent progress”.

## Applicability and transferability of the results

ThinkMOTION contributed to the objectives of CIP program by incorporating more than 71.000 items and securing access to them through Europeana. This unique content has potential for use in many sectors, such as e-Education (support in technical studies and enhancer of knowledge on historical background of mechanical engineering). Users may be students, engineers, teachers and others. The 3D animations may be of interest for the audiovisual/advertising movie industry. The work in small scanning units and the innovative way in obtaining IPR agreements may be transferred to other domains.



## Fields of interest

- mechanism and mobile mechanical systems
- history of machine science
- digitization of analogue documents
- software development and implementation
- multilingual digital library

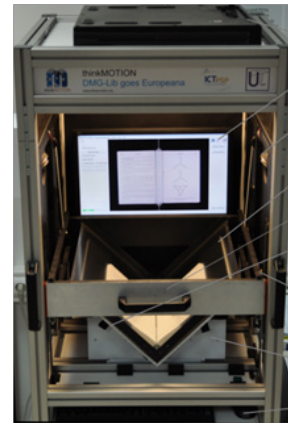

## Research centre

Research Centre for Mechatronics and Robotics

## Financed through/by

thinkMOTION, developed within the FP7, was funded under the Information and Communication Technologies Policy Support Programme. Area: CIP-ICT-PSP.2009.2.3 - Digital Libraries: European Digital Library Digitising content for Europeana.

## Research team

E.Lovasz, C.Gruescu, I.Cărăbaș, V.Ciube, D.Mărgineanu, R.Militaru, C.Sticlaru, A.Lovasz, E.Zăbavă, D.Perju, L.Dehelean, N.Dehelean, I.Maniu, V.Dolga, I.Bogdanov, D.Resiga, V.Argeșanu, A.Dobra, E.Ianoși, C.Moldovan, S.Grigorescu, G.Savii, D.Țucu, L.Bereteu, V.Văcărescu, V.Mesaroș-Anghel, A.Diaconu, I.Doroftei, D.Stan, D.Mândru, A.Repanovici, C.Rădulescu, L.Ciurdariu, D.Grosseck .

## Contact information

Assoc. Prof. Erwin-Christian LOVASZ, PhD  
Assoc. Prof. Corina Mihaela GRUESCU, PhD  
Department of Mechatronics  
Address: Bv. Mihai Viteazu, No.1, RO300222, Timisoara  
Phone: (+40) 403 542/ (+40) 403 557  
E-mail: erwin.lovasz@upt.ro  
E-mail: corina.gruescu@upt.ro

## NEW HAPTIC ARM EXOSKELETONS FOR ROBOTICS AND AUTOMATION IN SPACE

### Goal of the project

The project seeks to develop in Romania the capacity to design and manufacture special assemblies meant to work in the field of Robotic Exploration. The overall goal is to stimulate Romania's participation to international space missions and programs, in collaboration with ESA (European Space Agency), as its 19th member. The practical task is to develop a new haptic arm exoskeleton designed to enable in-space force-feedback telemanipulation with redundant robotic arms.

### Short description of the project

EXORAS will provide a new haptic arm exoskeleton for robotic exploration. The exoskeleton is desired to explore future ways of commanding a manipulator arm in space. It will be created a prototype with special features of the design, namely several shortcomings of previous telemanipulation systems will be removed. The new system pursues requirements regarding weight, ease of wearing and comfort of the human operator. The project assumes the full design, assembling and testing of the prototype. All aspects are taken into account: kinematics, dynamics, sensorics, wireless control, haptic feed-back, actuation, materials and so on.

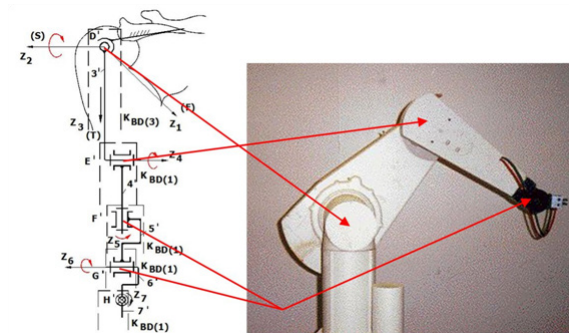

### Project implemented by

- Technical University of Cluj-Napoca – Coordinator
- University "Transilvania" Brasov – Partner 1
- University Politehnica of Timisoara – Partner 2

### Implementation period

2012 - 2015

### Main activities

- Research on the development of exoskeleton haptic systems for robotic exploration (existing solutions and development of new solutions; establishment of basic components with functional and technical specifications)
- Concept, design and assembly (mechanical design, kinematic analysis, development of control software, simulation)
- Testing and optimizing of prototypes (assembling, testing and optimizing of prototypes)

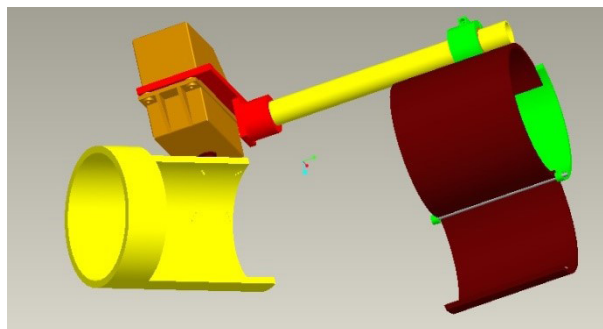



## Results

At this stage, the research work on existing solution lead to the design and partial implementation of new six solutions of exoskeleton arm. A generic scheme of the general concept from kinematic point of view is given in figure 1.

The solutions developed until now focused mainly to the elbow joint, which, functionally, is considered the most representative. The six variants of exoskeleton under study use:

- servo rotary drive mounted directly on the shaft of the joint (fig. 2)
- linear actuation and transformation of motion (fig. 3)
- free motion and electromagnetic brake (movement transmission via a wire mechanism)
- free motion and electromagnetic brake (fig. 4)
- haptic feedback generated by myostimulation
- haptic feedback generated by vibration modules.

## Applicability and transferability of the results

EXORAS fulfills entirely the scope of STAR program (of Romanian Space Agency) that aims increasing of the research competitiveness for participation of academic entities to activities of ESA, included in the law no. 262/2011 regarding the membership status to ESA. This project is going to produce clear benefits to the consortium partners and beyond, regarding the competitiveness of the market for hi-tech mechatronics and robotics. In addition, the gain in knowledge is going to be transferred into the higher-education support.

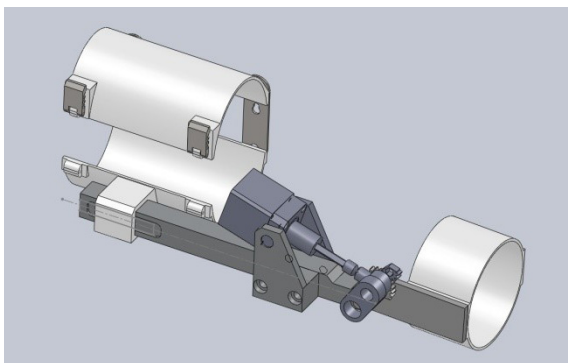

## Fields of interest

- robotics
- haptic devices
- mechanisms science
- automated control
- space exploration

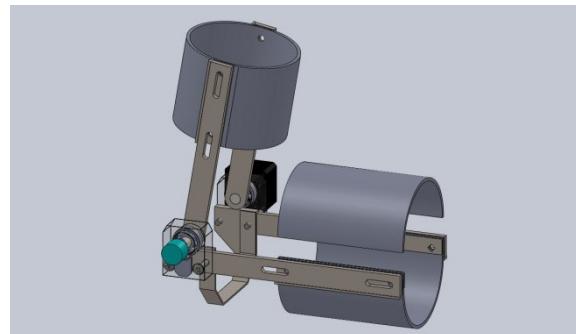

## Research centre

Research Centre for Mechatronics and Robotics

## Financed through/by

Funded by the Romanian Space Agency (ROSA) through Contract nr. 13/19.11.2012 within the program STAR 2012 – Projects of RDI, Research direction: S1 Research

## Research team

E.-C. Lovasz, V. Ciupe, D. Mărgineanu, C. M. Gruescu, I. Cărăbaș, E. Zăbavă, A. Diaconu, I. Maniu, V. Dolga, M. Mateaș.

## Contact information

Assoc. Prof. Erwin-Christian LOVASZ, PhD  
Department of Mechatronics  
Address: Bv. Mihai Viteazu, No.1, RO300222, Timisoara  
Phone: (+40) 256 403 542  
E-mail: erwin.lovasz@upt.ro

## EXPLORATION SYSTEM FOR OPTIMIZATION OF SHAPE MEMORY ACTUATION IN COMPOSITIONAL SPREADS

### Goal of the project

The project aims to design, fabricate and develop a combinatorial exploration system for optimization of microactuation using the sputtering technique of thin film compositional spreads.

### Short description of the project

The project has as main fundamental objectives the development of an exploration system that would allow:

- a combinatorial optimization of actuation using the sputtering technique to generate compositional spreads;
- the development of models for combinatorial systems adapted for investigation of actuation;
- the implementation of the combinatorial exploration system for the case of intelligent materials, with focus on shape memory alloy families;
- the development of microactuators with controlled and optimized functionality;
- the investigation or modelling of systems for the exploration, and
- the microfabrication of materials with "on demand" properties, adapted for applications in microsystem engineering.

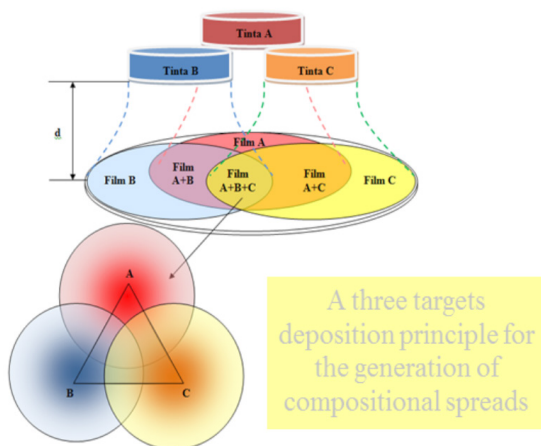

### Main activities

Several experimental objectives have been defined:

- identification of specific design requirements for a system dedicated to generating combinatorial libraries of metallic materials;
- design of an exploration path for specific functionalities;
- design and fabrication of an exploratory system that allows sputtering of compositional spreads;
- design and microfabrication of substrates for the investigations of functional libraries;
- microfabrication of sputtered compositional spreads based on shape memory alloy compositions;
- microstructural-compositional characterization of libraries;
- design of an actuator based on thin film microfabrication.

The exploratory system aims to accelerate the innovation process in the fabrication of micro sensors and actuators.

### Project implemented by

A research group of the Department of Materials and manufacturing Engineering of the "Politehnica" University of Timisoara

### Implementation period

2011-2014

## Results

A combinatorial deposition system was designed and is in the process of being finalized for the smart materials investigations. A model for the prediction of actuation in bimorphs based on shape memory alloy films was identified. Substrates for deposition of thin films were manufactured by laser cutting.

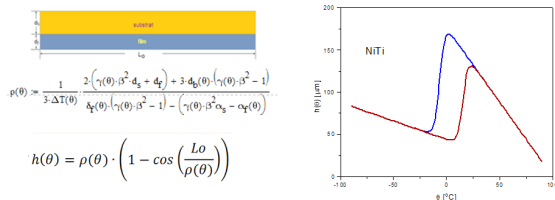

## Applicability and transferability of the results

The output of the project is related to the development of a high-performance research instrument which will facilitate the initiation of accelerated innovation processes in the advanced functional materials field. Actuators like the ones for which the project develops an advanced R&D tool are expected to increase the development of miniaturized products and expected to take over a variety of functions in microsystem dedicated to future aircraft, translating electronic or optical equipments.

## Fields of interest

Materials Engineering, Smart Sensors and Actuators, Micro and nanoengineering, Microsystems.

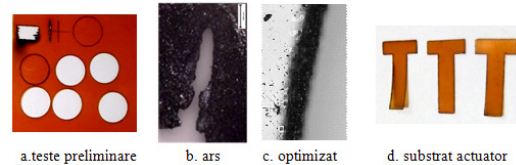

## Research centre

R research Centre for Processing and Characterization of Advanced Materials

## Financed through/by

Romanian National Authority for Scientific Research, grant CNCS – UEFISCDI, project number PN-II-ID-PCE-2011-3-0837

## Research team

Members and collaborators of the Department of materials and Manufacturing Engineering:

- Assoc. Prof. Corneliu M. Craciunescu
- Prof. Victor Budau
- Prof. Ion Mitelea
- Assoc. Prof. Aurel Ercuta

## Contact information

Assoc. Prof. Corneliu M. Craciunescu, PhD  
 Department of Materials and Manufacturing Engineering  
 Address: Bd. Mihai Viteazu, No. 1, RO300222, Timisoara  
 Phone: (+40) 256 403 655  
 Fax: (+40) 256 403 523  
 E-mail: corneliu.craciunescu@upt.ro



## HIGH PERFORMANCE LIGHTWEIGHT PANELS WITH A NEW OPTIMIZED DESIGN FOR ADVANCED AIRCRAFT STRUCTURES

### Goal of the project

Design of aircraft panels, made of metal and composite material, flat and curved, with improved performances.

### Short description of the project

Evaluation of the properties of some sandwich panels having an ultra light core, spatially folded. An increase of their performances with respect to the honeycomb core sandwiches is expected.

Designing and evaluation of simple solutions as to achieve constructive orthotropic panels with increased carrying capacity, having double or triple core. By choosing the materials and the component geometry the mechanical properties will be conveniently changed from one layer to another.

The designing of hybrid assembly solutions (structural adhesives and mechanical fastening) of sandwich plates having the core and skins made of dissimilar materials.

The use of prefabricated and commercially available materials, such that the costs of the designing, manufacturing and homologation of the designed panels will be minimized.

Development of procedures for simulating the mechanical response of the panels, using homogenization method for a more simple and efficient design process.

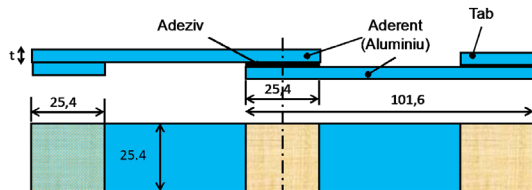

### Project implemented by

- University Politehnica Bucuresti - Coordinator
- Straero S.A - Partner 1
- University Politehnica Timisoara - Partner 2
- INAS S.A. - Partner 3
- SMART Mechanics S.R.L. - Partner 4

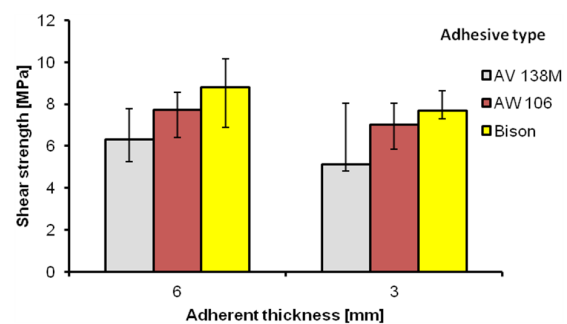

### Main activities

- Characterization of three types of structural adhesives: Araldit AV138 M1 + HV 998, Araldit AW 106 + HV 953U and Bison using tensile tests and vibration excitation technique.
- Characterization of mechanical properties of metallic materials used for faces and cores in sandwich structures
- Static tests on single and double lap joints for the characterization of the behavior of structural adhesives at ambient temperature.
- Numerical simulations of the behavior of doubler adhesive joints.
- Numerical simulation of the adhesive joints under four point bending.

### Implementation period

02.07.2012 - 30.06.2015

### Research centre

R research Centre for Processing and Characterization of Advanced Materials

## Results

Identification of new mechanical interconnection solutions for the skins, using elements that cross the core of the sandwich, which are simpler, more efficient and cheaper than those currently in use. Skins interconnection is more convenient in the case of rigid polymeric foam core. Thus, the risk of delamination is reduced and this procedure is expected to increase the rigidity and resistance of the designed panels.

Conference Papers:

- Negru R., Marsavina L., Caplescu C., Filipescu H., Assessment of brittle mixed -mode fracture using the theory of critical distances, Proceedings of International Conference on Innovative Technology, IN-TECH 2013, Budapest 10-13.09.2013, p. 313-316, ISBN 978-953-6326-88-4

## Applicability and transferability of the results

Results and design solutions will be transferred to sandwich structure manufacturers to improve their technologies. Also, companies involved on design of aircraft will benefit by our developed sandwich structures and hybrid assembly solutions.

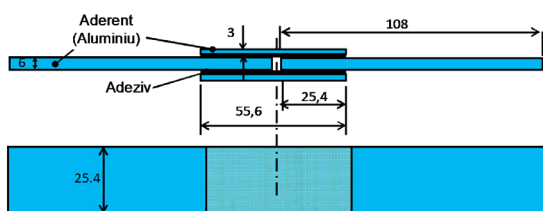

## Financed through/by

PN-II-PT-PCCA-2011-3.2-0068 CONTRACT 206/2012, EXECUTIVE AGENCY FOR HIGHER EDUCATION, RESEARCH, DEVELOPMENT and INNOVATION FUNDING (UEFISCDI)

## Fields of interest

- Composite and sandwich structures
- Mechanical testing of composite materials
- Finite Element Analysis of sandwich structures
- Fracture and Damage Mechanics of composite structures

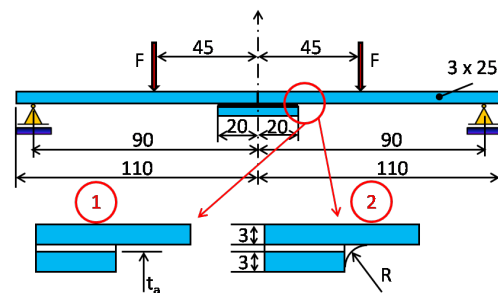

## Research team

Prof. Dr. Eng. Liviu Marsavina  
 Prof. Dr. Eng. Nicolae Faur  
 Dr. Eng. Mihai Hluscu  
 Dr. Eng. Radu Negru  
 Dr. Eng. Anghel Cernescu

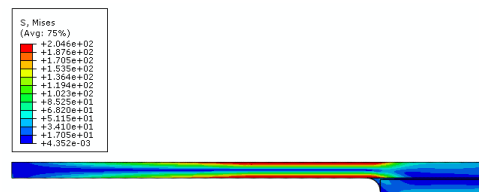

## Contact information

Prof. Liviu MARSAVINA, PhD  
 Department Mechanics and Strength of Materials  
 Address: Bd. Mihai Viteazu, No. 1, RO300222, Timisoara  
 Phone: (+40) 256 403 577  
 Fax: (+40) 256 403 523  
 E-mail: liviu.marsavina@upt.ro

## IMPROVEMENT OF THE TITANIUM WEAR RESISTANCE BY ELECTRON BEAM REMELTING OF THE PRE-DEPOSITED THERMAL

### Goal of the project

Improvement of the exploitation performance of the titanium, especially wear behavior, without influencing its good corrosion resistance.

### Short description of the project

Titanium is one of the most promising metals in field of high specific strength engineering. Although it offers attractive mechanical, chemical and physical properties, its surface properties are deficient, possessing poor fretting fatigue resistance and poor wear resistance properties. Thermal spray coatings is one of the most common ways to improve the surface characteristics of the materials being used in a wide range of industries to improve the abrasive, erosive, and sliding wear of machine components.

The proposed theme focuses on the improving of the titanium wear resistance by electron beam (EB) remelting of the pre-deposited oxidic powder Al<sub>2</sub>O<sub>3</sub>-TiO<sub>2</sub> using the high velocity oxygen fuel (HVOF) and atmospheric plasma spraying (APS) methods. The EB treatment may lead to the elimination of porosity, enhancement of the coating strength and chemical homogeneity, and the development of metallurgical bonding at the coating-substrate interface producing strengthened coatings adhesion.

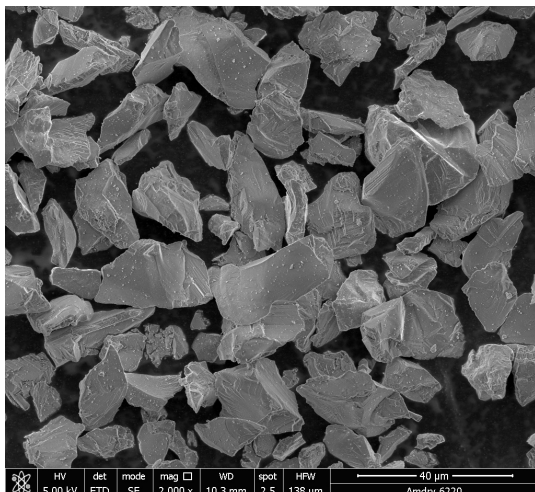

### Main activities

- State of the art and perspectives evaluation in surface coatings technique used as a method in order to improve the wear behavior of the titanium;
- Development of HVOF and APS sprayed Al<sub>2</sub>O<sub>3</sub>-TiO<sub>2</sub> coatings on the surface of titanium and their remelting using the electron beam (EB) method;
- Analysis and characterization of the obtained HVOF sprayed Al<sub>2</sub>O<sub>3</sub>-TiO<sub>2</sub> coatings before and after the electron beam remelting treatment;
- Study of the wear and corrosion behavior of the coatings before and after the electron beam remelting;

### Results

For the first stage of the project it has been obtained the following results:

- study regarding the analysis of the factors which cause the tendency of using the surface protection coatings as a method to improve of the titanium
- Study regarding of the analysis of technologies which produce these coatings
- researches about opportunity of production and possibility of applying these coatings

### Project implemented by

Politehnica University of Timisoara

### Implementation period

02.09.2013-30.11.2015

## Applicability and transferability of the results

The results which will be obtained in frame of the project will be transferred to companies in the field of automotive industry and not only. Also they will be presented to national and international conferences and published in scientific journals.

## Fields of interest

The main fields of interest approached in the project are: material science, surface engineering, advanced materials.

## Research centre

Research Centre for Processing and Characterization of Advanced Materials

## Financed through/by

EXECUTIVE UNIT FOR FINANCING EDUCATION HIGHER RESEARCH DEVELOPMENT AND INNOVATION (UEFISCDI)

## Research team

Project manager: Ion-Drăgoș UTU

Team members:

Viorel-Aurel SERBAN – senior researcher

Cosmin CODREAN – senior researcher

Carmen OPRIS – senior researcher

Iosif HULKA – postdoc researcher

## Contact information

Assist. Prof. Ion-Drăgoș UȚU, PhD

Materials and Manufacturing Engineering Department, Faculty of Mechanical Engineering

Address: Bd. Mihai Viteazu, No. 1, R0300222, Timisoara

Phone: (+40) 256 403 656

E-mail: dragos.utu@upt.ro

## PROCESSING OF MECHANICAL PARTS RESISTANT TO WEAR AND TEMPERATURE USING REACTIVE SINTERING OF AL-AL<sub>2</sub>O<sub>3</sub> COMPOSITES

### Goal of the project

The main purpose of the project is to develop a class of specific composites based on aluminum and nanoparticles of aluminum oxides. These advanced cermets preserve their properties at high temperatures and are wear resistant.

### Short description of the project

This project aims to obtain new materials and advanced technologies with large applicability and with rapid development of this field. The parts obtained using these materials are of high class, given by their technical and economical performances. They also contribute to the reduction of environment pollution by low emanation of heat and combustion gases in the atmosphere.

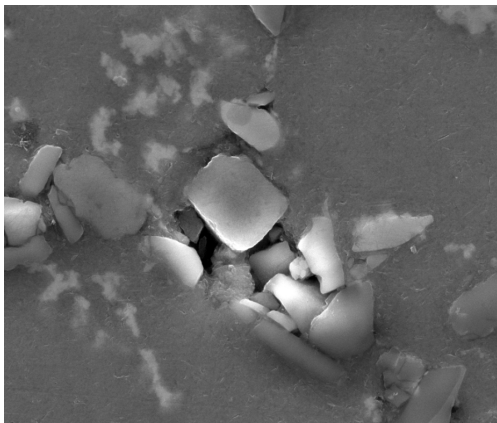

### Main activities

For the first stage of the project, the main activities include the analysis on the intergrain phenomena that take place in the morphology of the pores during reactive sintering of the composites.

### Project implemented by

SC ICPT TEHNOMAG CUG SA Cluj Napoca - coordinator of the project, Politehnica University of Timisoara, Department for Materials Engineering and Fabrication – Partner 1, SC TEHNOMAG SA Cluj Napoca – Partner 2 and SC TEHNOEXPERT SRL Cluj Napoca – Partner 3

### Results

- Study of the intergrain phase transformation at reactive sintering
- Study regarding the computer processing of morphologic modifications of pores and structure at reactive sintering
- Computer modelling of the morphologic transformation by diffusion at sintering
- Characterization of the cermets properties related to pores morphology and compounds resulting at reactive sintering

The main goal achieved during the first stage of the project was to emphasize the methods for control and analysis of the intergrain phenomena and pore modification during sintering of the Al-Al<sub>2</sub>O<sub>3</sub> cermets. The morphology of the pores (size, shape, characteristic dimensions, dimensional distribution) as well as the size and distribution of the compounds resulted after sintering were investigated by optical and scanning electronic microscopy (SEM). The images obtained were afterwards computer processed to find all the details about this new class of materials.

A computer model of the morphologic transformations by diffusion at reactive sintering was also elaborated in this stage.

### Implementation period

2012-2015

### Research centre

Research Centre for Processing and Characterisation of Advanced Materials

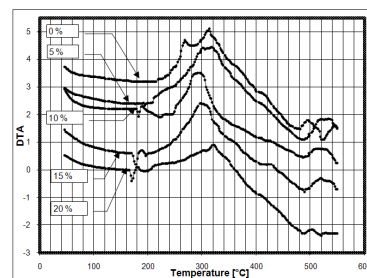

## Applicability and transferability of the results

The results obtained during the project will be transferred to companies in the field of automotive industry and will be presented on a web page accessible to all large public. Also, they will be presented during the AMS '13 Advanced Materials and Structures International Conference, a conference organized by the Department of Materials and Manufacturing Engineering from the Politehnica University of Timișoara.

## Fields of interest

The main fields of interest connected with the project applicability and implementation are: materials engineering, composite materials, environment protection.

## Financed through/by

UEFISCDI, PN II type project, Partnership in priority domains

## Research team

UPT team: Conf.dr.eng. Mircea Nicoară, director of the project, prof. dr.eng. Viorel-Aurel Șerban, conf.dr.eng. Aurel Răduță, As.dr.fiz. Cosmin Locovei, As.dr.eng. Carmen Opreș, Lector.dr.eng. Daniel Țunea, Conf.dr.eng. Dănuț Șoșdean

SC ICPT TEHNOMAG CUG SA: Dr.eng. Gheorghe Tudor Șurdeanu – director

SC TEHNOMAG CUG SA: Eng. Liviu Daianu – director

SC TEHNOEXPERT SRL: Eng. Viorel Mureșan – director

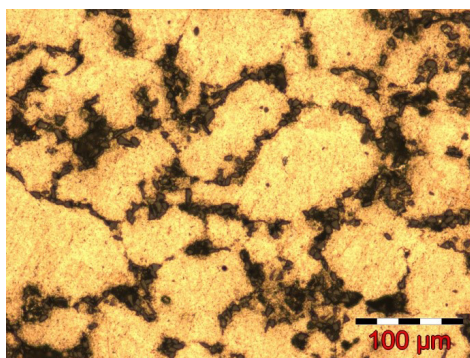

## Contact information

Assoc. Prof. Mircea NICOARĂ, PhD  
Department for Materials and Manufacturing Engineering  
Address: Bd. Mihai. Viteazu. No. 1, RO300222, Timisoara  
Phone/Fax: (+40) 256 403 626  
E-mail: mircea.nicoara@upt.ro

## MICROSTRUCTURE - MECHANICAL PROPERTIES RELATIONSHIP FOR METALLIC FOAMS

### Goal of the project

Intensification of the already existing, up to date on volunteer basis, international scientific and technological cooperation between Universitatea POLITEHNICA din Timisoara (UPT) ROMANIA and Institute of Materials and Machine Mechanics (IMMM) from Slovak Academy of Sciences (SAS) Bratislava, SLOVACIA. This will be achieved by elaboration of common journal papers, and reciprocal sustain of scientific events organised on the partner country, preparation of joint international projects on European basis.

### Short description of the project

The technology for foaming of aluminum alloys has been considerably improved in last decade worldwide.

Aluminum foam can undergo static loading, and accidentally dynamic or impact loading during the crash accident. Unfortunately, there is still missing detailed connection between static and dynamic mechanical behaviour of foams.

The project investigates the mechanical properties of metallic foams under dynamic and static loading with respect to foam microstructure.

The project belongs to the priority domain "7 New Materials, Micro and Nanotechnologies – 7.1 Advanced Materials". Cellular metals are a class of advanced materials and investigation on graded cellular metals (cellular structures with different densities in different part of the piece) will also be investigated in present project.

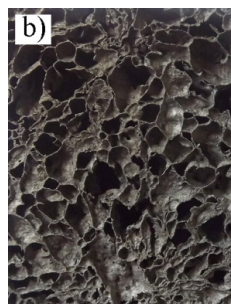
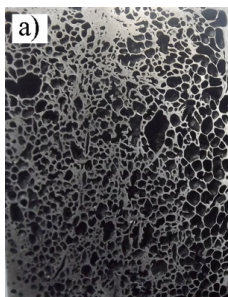

### Project implemented by

- Politehnica University of Timișoara, ROMANIA
- Institute of Materials and Machine Mechanics (IMMM) from Slovak Academy of Sciences (SAS) Bratislava, SLOVAKIA

### Main activities

- Production of aluminium foams by the Slovak partners.
- Mechanical testing of aluminum foams under static loading. Compression, tensile and bending tests will be carried on aluminum foam specimens. The relation between manufacturing parameters, density and mechanical properties will be investigated.

- Mechanical testing of aluminum foams under dynamic loading. Impact compression tests will be performed on aluminum foam specimens.

- Investigation of fatigue behavior of aluminium foam.

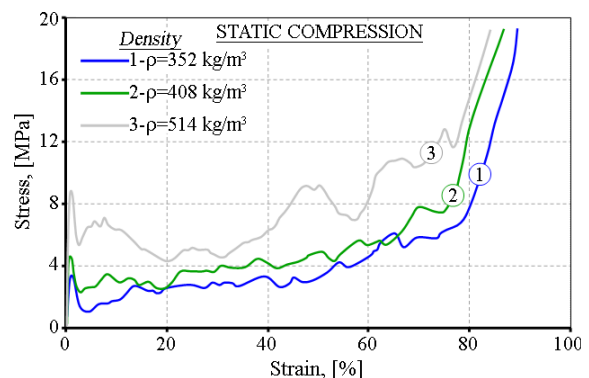

### Results

Journal Papers:

- E. Linul, T. Voiconi, L. Marșavina, J. Kováčik, A comparison between static and dynamic compression behavior of metal foams, International Journal of Impact Engineering (submitted)

Conference Papers:

- T. Voiconi, E. Linul, L. Marșavina, J. Kováčik, M. Kneć, Experimental determination of mechanical properties of aluminium foams using Digital Image Correlation, Key Engineering Materials (in press accepted paper).

### Implementation period

01.03.2013 – 10.12. 2014



## Applicability and transferability of the results

Results will be used by metallic foams manufacturers. Also, companies using foam components from automotive industry will benefit by our results in order to design better foam components as energy absorbers.

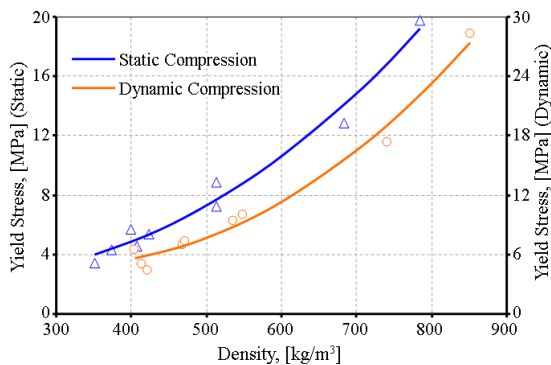
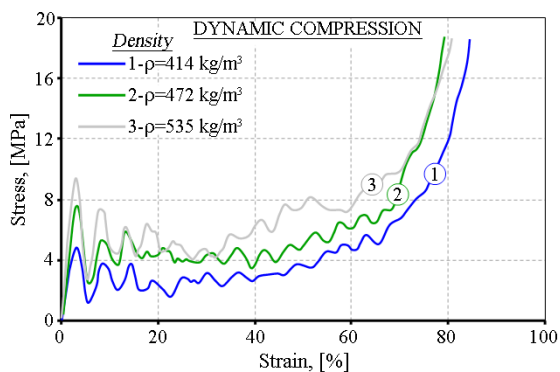

## Financed through/by

Contract Nr. 653/2013, by Romanian Ministry of National Education, through UEFISCDI

## Research team

at Politehnica University of Timișoara, ROMANIA

Prof. Dr. Eng. Liviu Marsavina – Coordinator

Prof. Dr. Eng. Dan M. Constantinescu

Dr. Eng. Emanoil Linul

Dr. Eng. Dragos A. Apostol

Eng. Dan A. Serban

Eng. Tudor Voiconi

at Institute of Materials and Machine Mechanics (IMMM) from Slovak Academy of Sciences (SAS) Bratislava, SLOVAKIA

Dr. Eng. Jaroslav Kovacik – Coordinator

Dr. Eng. Jaroslav Jerz

Dr. Eng. Roman Florek

Dr. Eng. Martin Nosko

Dr. Eng. Natalia Minarikova

Eng. Jana Harnuskova

## Research centre

R research Centre for Processing and Characterization of Advanced Materials

## Contact information

Prof. Liviu MARSAVINA, PhD

Department Mechanics and Strength of Materials, Faculty of Mechanical Engineering

Address: Bd. Mihai Viteazu, No. 1, R0300222, Timisoara

Phone: (+40) 256 403 577

Fax: (+40) 256 403 523

E-mail: liviu.marsavina@upt.ro



## MICRO-MECHANICAL MODELLING OF CELLULAR MATERIALS WITH REFINEMENTS ON FRACTURE AND DAMAGE

### Goal of the project

Cellular materials are widely used as cores in sandwich composites, for packing and cushioning. The main characteristics of foams are light weight, high porosity, high crushability and good energy absorption capacity. Present project propose to develop micro-mechanical models in order to predict the mechanical properties of cellular materials with a focus on modeling the fracture and the influence of damage on the mechanical response.

### Short description of the project

Project combines analytical methods, with numerical micro-mechanical finite element analysis and experimental investigations: materials testing and investigating the damage mechanisms by Digital Image Correlation and Thermoelastic Stress Analysis. The novelty of the project will be highlighted by the size and notch effect for cellular materials, and by investigating the effect of microstructural damage on the mechanical response of cellular materials.

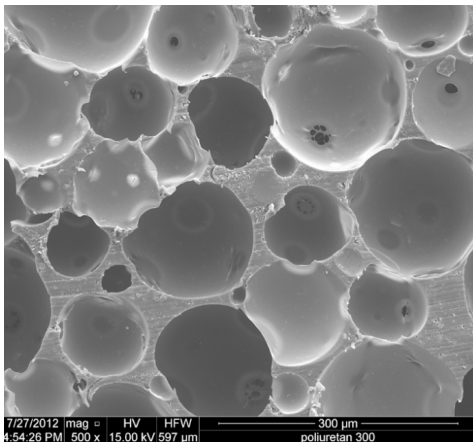

### Project implemented by

- Lublin University of Technology, Lublin, Poland
- Slovak Academy of Science, Bratislava, Slovakia
- Polymer Competence Center Leoben, Austria
- ILK, TU Dresden, Germany

### Implementation period

05.10.2011 – 04.10. 2014

### Main activities

Better understanding of mechanical behavior of cellular materials.  
Develop micro-mechanical models to estimate mechanical properties of cellular materials.

Implementation of constitutive material models in Finite Element Analysis.

Investigating the size effect and notch effect on cellular materials  
Evaluating the behavior of cellular materials under dynamic (impact and fatigue) loading.

Identification of damage mechanisms in cellular materials.

Investigating the effect of microstructural damage on the mechanical properties of cellular materials.

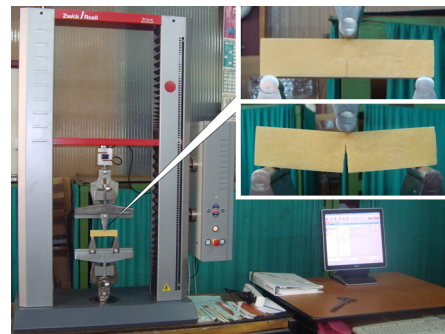

### Results

Main results for 2013 year:

- Journal Papers:
  - L. Marsavina, E. Linul, T. Voiconi, T. Sadowski, A comparison between dynamic and static fracture toughness of polyurethane foams, *Polymer Testing* 32 (2013) 673–680.
  - L. Marsavina<sup>1</sup>, D.M. Constantinescu, E. Linul, D. Apostol, T. Voiconi, T. Sadowski, Refinements on Fracture toughness of PUR foams, *Engineering Fracture Mechanics*, 2013, On-line accepted paper.
- Conference Papers:
  - E. Linul, L. Marșavina, T. Voiconi and T. Sadowski, Study of factors influencing the mechanical properties of polyurethane foams under dynamic compression, *Journal of Physics: Conference Series*, 451, 2013.

- L. Marsavina, D.M. Constantinescu, L. Linul, T. Voiconi, D.A. Apostol, T. Sadowski, Damage Identification and Influence on Mechanical Properties of Closed Cell Rigid Foam, CDROM Proceedings of the 13th International Conference on Fracture, Beijing, China, 16-21 June 2013.

• Book Chapter:

- E. Linul and L. Marsavina, Mechanical Characterization of Rigid PUR Foams Used for Wind Turbine Blades Construction, Book Chapter (Chapter 10) in "Advances in Materials Science and Applications", The World Academic Publishing Co., Ltd., p. 171-193, 2013

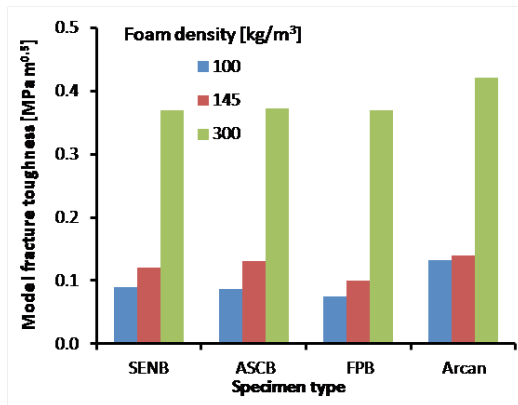

## Research centre

Research Centre for Processing and Characterization of Advanced Materials

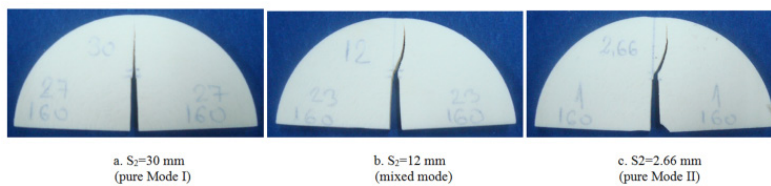

## Applicability and transferability of the results

Results will be used by foams manufacturers Necumer and Spumotim to improve their technologies. Also, companies using foam components like TRW Automotive and Adidas will benefit by our developed micro-mechanical models to characterize their components and in the product design.

## Fields of interest

- Composite and cellular materials
- Mechanical testing
- Finite Element Analysis
- Fracture and Damage Mechanics

## Financed through/by

Grant PN-II-ID-PCE-2011-3-0456, Contract Nr. 172/2011, by Romanian Ministry of National Education, through UEFISCDI

## Research team

Prof. Dr. Eng. Liviu Marsavina – Project Manager  
 Prof. Dr. Eng. Dan M. Constantinescu – Senior Researcher  
 Dr. Eng. Emanoil Linul – Postdoctoral Researcher  
 Dr. Eng. Cristian Nes – Postdoctoral Researcher  
 Dr. Eng. Dragos A. Apostol – Postdoctoral Researcher  
 Eng. Dan A. Serban – Postdoctoral Researcher  
 Eng. Tudor Voiconi – PhD student  
 Eng. Florin Stuparu – PhD student

## Contact information

Prof. Liviu MARSAVINA, PhD  
 Department Mechanics and Strength of Materials, Faculty of Mechanical Engineering  
 Address: Bd. Mihai Viteazu, No. 1, R0300222, Timisoara  
 Phone: (+40) 256 403 577  
 Fax: (+40) 256 403 523  
 E-mail: liviu.marsavina@upt.ro

## HIGH MAGNETIZATION MAGNETIC NANOFUIDS AND NANO-MICRO COMPOSITE MAGNETIZABLE FLUIDS-MAGNANOMICROSEAL

### Goal of the project

The project is oriented to the extension of performances of rotating seals and adaptive motion control devices to meet the requirements of several well-defined new applications, by high and very high magnetization sealing fluids and new type of magnetorheological fluids to be synthesized.

### Short description of the project

The project concept and objectives are illustrated schematically in figure 1.

The workflow is organized as follows: lab- and micropilot scale synthesis of high magnetization and radiation resistant magnetic nanofluids and nano-micro composite fluids for heavy duty rotating seal and semi-active magnetorheological motion control applications; advanced structural, magnetic, rheological, magnetorheological characterization of the new magnetizable fluids; accelerated ageing and sealing capacity tests; design, manufacturing and experimental testing of leakage-free rotating seals for nuclear equipments and magnetorheological rotation speed controller devices for hydraulic turbomachines. The seal systems proposed for nuclear equipments offer much higher level of environmental protection over traditional sealing units due to the leakage-free property of magnetic fluid rotating seals, increasing the commercial value of the solutions proposed.

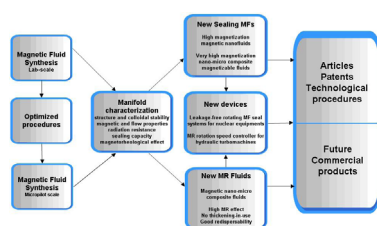

### Project implemented by

- Romanian Academy – Timisoara Branch (project coordinator), Politehnica University of Timisoara (Partner 1),
- SC ROSEAL SA Odorheiu Secuiesc (Partner 2) and National Institute for R&D in Electrical Engineering ICPE-CA Bucuresti (Partner 3).

### Main activities

- (1) Synthesis, surface coating and dispersion of nano and micron size magnetic particles in non-polar and polar carriers. Influence of composition, particle size and volume fraction on colloidal stability, magnetic properties and flow behavior;
- (2) Magnetic nanofluids and nano-micro composite magnetizable fluids for high pressure rotating seals and magnetorheological devices. Magnetic nanofluids for heavy duty rotating seals. Qualification Procedure;
- (3) Design, fabrication and testing of magnetofluidic rotating seals for special exploitation conditions;
- (4) Design, fabrication and testing of a semi-active MR rotational speed controller for hydraulic turbomachines.

### Results

The main results of this project refer to the elaboration of the following: (i) technological procedures: synthesis of high magnetization sealing fluids; synthesis of nano-micro structured magnetorheological fluids; and (ii) qualification 1 procedures: magnetic nanofluids for sealing applications in nuclear equipments; magnetic nanofluids for rotating seals for nuclear equipments.

The contributions of Politehnica University of Timisoara refer mainly to complex magnetic, rheological and magnetorheological analyses of the magnetic sealing fluids and nano-micro structured magnetorheological fluids.

Also, the involved procedures, technologies, devices and know-how are favourable for patent applications, as well as for development and exploitation by the industrial partner from the project.

### Implementation period

2012-2015

## Applicability and transferability of the results

The technological progress is strongly evidenced by future commercial products planned for the industrial partner SC ROSEAL SA: 16 new type of magnetically controllable fluids, 1 prototype and 3 functional models of magnetofluidic devices for nuclear and hydraulic power engineering.

## Fields of interest

Synthesis of magnetic nanofluids and nano-micro composites; accelerated ageing test procedures for organic compounds; magnetic, magneto-rheological and thermal investigation of magnetizable fluids; design and manufacturing of rotating seal devices; investigation of swirling flow phenomena.



## Research centre

Research Centre for Complex Fluid Systems Engineering

## Financed through/by

Ministry of National Education - Executive Agency for Higher Education, Research, Development and Innovation Funding (UEFISCDI) through the PN II Program Partnerships in Priority Areas, Collaborative Applied Research Projects.

## Research team

Dr. Ladislau VÉKÁS, Project coordinator; Research team at Politehnica University of Timisoara (Partner 1): Assoc. Prof. Dr.-Eng. Floriana D. ST OIAN, project responsible, Phys. Oana MARINICĂ, Lect. Dr.-Eng. Mat. Sorin HOLOT ESCU, Assoc. Prof. Dr.-Eng. Nicolae CRANIC, Lect. Dr.-Eng. Andreea DOBRA, Lect. Dr.-Eng. Adelina HAN, Res. Assist. Florica BĂLĂNEAN, Res. Assist. George GIULA.

## Contact information

Prof. Ladislau VÉKÁS, PhD  
Center for Fundamental and Advanced Technical Research,  
Romanian Academy-Timisoara Branch  
Address: Bd.Mihai Viteazu, No. 24, RO300223Timisoara  
E-mail: vekas@acad-tim.tm.edu.ro  
Phone: (+40) 256-403 700; (+40) 256-403 703  
Fax: (+40) 256-403 700

Assoc. Prof. Floriana Daniela STOIAN, PhD  
Address: Bd. Mihai Viteazu, No. 1, RO300222, Timisoara  
Phone: (+40) 256 403 671  
E-mail: floriana.stoian@upt.ro  
Web: <http://acad-tim.tm.edu.ro/magnanomicroseal/>

## SELF-INDUCED INSTABILITIES OF THE SWIRLING FLOW IN HYDRAULIC TURBINES FAR FROM THE BEST EFFICIENCY REGIME

### Goal of the project

The project purpose is to develop an integrated methodology for a-priori quantitative assessment of the swirling flow unsteadiness in hydraulic turbines, thus providing the necessary tool for swirl optimization before actually designing the turbine runner. Such a methodology is required in order to answer the current requirements for modern turbines, which must operate safely within a large range of discharge values, quite often far from the best efficiency point.

### Short description of the project

We develop mathematical models, numerical algorithms and computer codes for axisymmetric turbomachinery swirling flows including the axisymmetric vortex sheet developed downstream the runner at off-design operating regimes. Then, we analyze the stability of the axisymmetric swirling flow with a central stagnant region bounded by a vortex sheet.

The scenario for axisymmetric vortex sheet instability and further development of a precessing helical vortex (vortex rope) is investigated by unsteady, three-dimensional, turbulent flow computations in real geometries of hydraulic turbine draft tube, in order to validate the main hypothesis adopted in the present study. Validation of the methodology for quantitative a-priori assessment of the unsteadiness level of the swirling flows issued from the hydraulic turbine runners when operating far from the best efficiency point will use experimental data obtained on a swirl apparatus, including both LDV and unsteady pressure measurements.

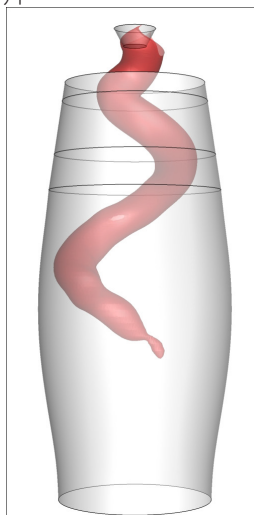

### Project implemented by

Turbomachinery Hydrodynamics Division, Research Centre for Complex Fluid Systems Engineering, Politehnica University Timișoara

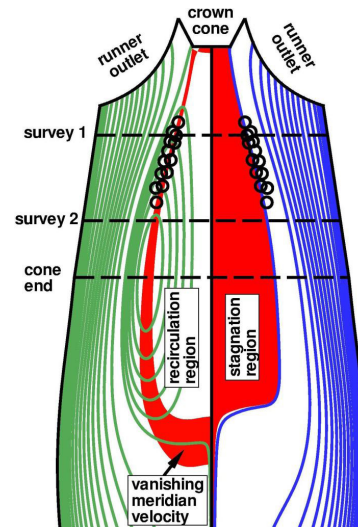

### Main activities

Objective 1. Develop mathematical models, numerical algorithms and computer codes for axisymmetric turbomachinery swirling flows including the axisymmetric vortex sheet developed downstream the runner at off-design operating regimes.

Activity 1.1. Development of the mathematical model for 2D swirling flow, with stagnant region.

Activity 1.2. Implementation of the numerical algorithm and code development

The project develops a novel model to account for the swirling flow within the meridian cross-section of the turbine, which also solve the problem of singularity at the axis, currently dealt with by truncating the computational domain away from the axis. The vortex sheet originates from an inviscid separation on the runner crown, and evolves into the conical diffuser further downstream.

### Implementation period

2013-2015

## Results

Within the period sep.–dec. 2013 we validated a novel variational formulation for axisymmetric, steady swirling flows. While the functional for the Bragg–Hawthorne equation is minimized within the flow region, the new augmented functional which includes the contribution of the stagnant region is maximized with respect to the stagnant region extent.

From physical point of view, this corresponds to the minimization of the swirl number for the equilibrium configuration of the swirling flow, as expected. Our model considers that the stagnant region is bounded by a vortex sheet with a velocity jump but with continuous static pressure, as required for a fluid interface. A simple example for free swirl in a pipe shows that development of a central stagnant region avoids the axis singularity.

## Applicability and transferability of the results

The basic research in turbine hydrodynamics was traditionally focused on improving efficiency of hydraulic-to-mechanic energy conversion at peak efficiency or in the neighborhood. However, the need to compensate in real time the wind-power fluctuations requires new approaches to safely increase the flexibility in operating hydraulic turbines. In particular, there is a need for methodologies to assess and minimize the flow instabilities and associated severe pressure fluctuations, and this project is developing the foundation to answer such demands through basic research developments.

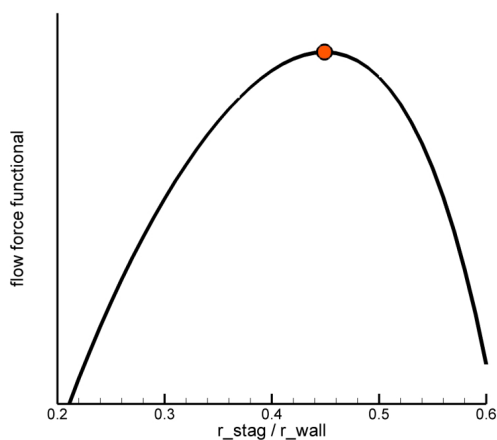

## Fields of interest

- Turbomachinery hydrodynamics, optimized design and flow control at off-design regimes
- Swirling flow hydrodynamics and instability
- Mathematical models and numerical algorithms for swirling flows
- Experimental investigation of swirling flows (Laser Doppler Velocimetry, unsteady pressure measurements)

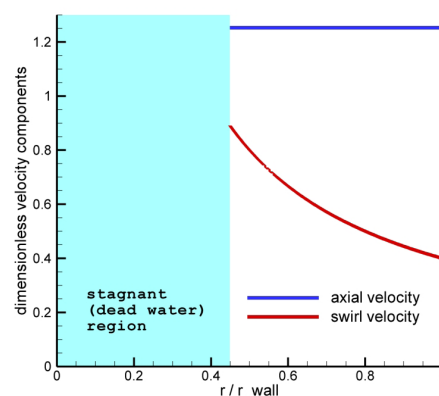

## Research centre

Research Centre for Complex Fluid Systems Engineering

## Financed through/by

This work is supported by a grant of the Ministry of National Education, CNCS – UEFISCDI, project number PN-II-ID-PCE-2012-4-0634.

## Research team

Romeo SUSAN-RESIGA, PhD, Professor, project director  
 Sebastian MUNTEAN, PhD, Senior Researcher  
 Adrian STUPARU, Postdoctoral researcher  
 Alin BOSIUC, PhD, Postdoctoral researcher  
 Constantin TĂNASĂ, Postdoctoral researcher  
 Tiberiu CIOCAN, Doctoral student  
 Cosmin IGHÎȘAN, Doctoral student

## Contact information

Prof. Romeo SUSAN-RESIGA, PhD  
 Department of Mechanical Machines, Equipment and Transportation  
 Address: Bv. Mihai Viteazu, No.1, RO300222, Timisoara  
 Phone: (+40) 256 403 689  
 E-mail: romeo.resiga@upt.ro



## ANALYTICAL AND NUMERICAL METHODS FOR LINEAR AND NONLINEAR STABILITY ANALYSIS OF SWIRLING FLOWS

### Goal of the project

The main objective of the project is to elaborate an improved methodology for investigating swirling flows stability using the mathematical analysis of hydrodynamic instabilities. The proposed methods are based on the application of stability and bifurcation analysis techniques in order to understand the dominant linear/ nonlinear instability of the swirling flows problems with applications in turbomachinery.

### Short description of the project

The project approaches the fundamental problem of hydrodynamic stability of swirling flows. A large area of applications in problems of meteorological, aerodynamical or fluid dynamics significance has renewed the interest in the stability analysis of swirling, inviscid flows domain and the relation between the onset of vortex breakdown and hydrodynamic instability of the flow has been put under consideration. The occurrence of the precessing vortex and other instabilities in turbomachinery applications, address the mathematical modeling, the dynamic and stability of swirling flows, as well as the vortex breakdown phenomenon, which are all examples of fundamental problems in fluid dynamics.

We propose spectral methods based methodology that can be used for investigating classical questions addressed for swirling flows. Linear and non-linear stability theory offer a quantitative description of the flow behavior when infinitesimal disturbances are superimposed on the basic flow. Most fluid flows display either a growth in space or a complex spatio-temporal growth of disturbances. The main purpose is to conduct stability investigations based on the analysis of self-induced perturbations propagation in the swirling flow which will allow the recovery of the most relevant information using available computer resources in a very short time for a set of parameters.

### Project implemented by

The Department for Mathematics, University "Politehnica" of Timisoara, numerical data and equipment from National Center for Engineering of Systems with Complex Fluids (NCESCF) (at University "Politehnica" of Timisoara).

### Implementation period

05.10.2011-04.10.2013

### Main activities

The main activities are adequate for the proposed objectives:

- Analytical analysis of spectral methods for investigating the stability of the flow with a research on efficient implementations of linear solvers in the area
- Validate the results with data obtained by the experimental programs considered at NCESCF
- Actual application of the methods to problems triggered by swirling fluid dynamics
- Verification under industrially relevant conditions which will help in establishing the validity of the developed models

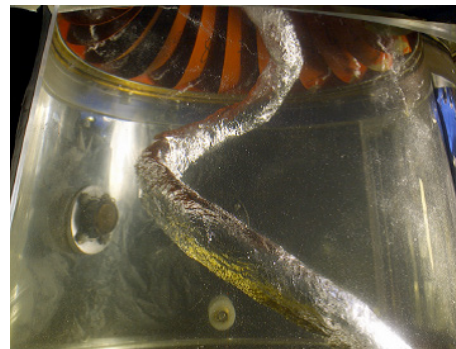

### Fields of interest

The related physics problem is complex with important engineering applications. Solving of the problem using CFD techniques is challenging and time consuming. The approach of the problem using spectral method, which offers an alternative method can reveal important and complex physics and thus to improve engineering design in an efficient way. The researches of the project imply solving present days problems in turbomachinery hydrodynamics in order to understand fundamental aspects of the swirling flow hydrodynamic mechanisms so that one can chose the most efficient flow control method.

## Results

- Numerical results on the physical parameters values for the swirling flows problems with application in turbomachinery
- Numerical analysis for the eigenvalue problems governing the linear stability of swirling flows
- Convective/absolute instability analysis of swirling flows
- Extension of the 1D solver for solving columnar swirling flows to the 2D case

The results were presented to international meetings on the subject and/ or published in international journals or proceedings.

1. Dijkstra, H. A., Wubs, F.W., Cliffe, A. K., Doedel, E., Dragomirescu, F.I., Eckhardt, B., Gelfgat, A.Y., Hazel, A., Lucarini, V., Salinger, A.G., Phipps, E.T., Sanchez-Umbria, J., Schuttelaars, H., Tuckerman, L. S., Thiele, U., Numerical Bifurcation Methods and their Application to Fluid Dynamics: Analysis beyond Simulation, submitted to Communications in Computational Physics (submitted 24.09.2012)
2. Dragomirescu, F. I., Efficient polynomials based method for a temporal stability investigation in a swirling flow stability problem, Proceedings 9th International Conference on Mathematical Problems in Engineering, Aerospace and Sciences (ICNPAA), Vienna University of Technology, Vienna, Austria, 10-14 Iulie, 2012, AIP Conf. Proc. 1493, pp. 322-329.
3. Dragomirescu, F.I., Susan-Resiga, R., Muntean, S., On the Laguerre functions based Galerkin type method in a swirling flow stability problem with applications in turbomachinery, Proceedings of the conference Mathematical Models in Engineering Science, Paris, Dec. 2012, 228-233.
4. Dragomirescu, F. I., Siddheshwar, P. G. Ene, R. D., Influence of micropolar parameters on the stability domain in a Rayleigh-Benard convection problem - A reliable numerical study, acceptat spre publicare in Italian Journal of Pure and Applied Mathematics, vol. 31, acceptat 16.06.2012.
5. Dragomirescu, F. I., Moisa, I., On Convective/Absolute Instabilities Quantification in Swirling Flows in Turbomachinery, Proceedings of the 13th International Conference of Mathematics and its Applications ICMA2012, Timisoara, Noiembrie 2012, 211-216.
6. Dragomirescu, F. I., Nonclassical polynomials based Galerkin formulation in a swirling flow stability problem, Proceedings of APLIMAT 2013, Bratislava, Feb. 5-7, 2013, p.17, 8pages.

The conclusions and a final report will be delivered at the end of the project.

## Applicability and transferability of the results

The feasibility of the project is sustained by its significantly important engineering theme, with the results of importance for both applied mathematics and engineering. The main, and most important, goal is to explore the application of our methods modeling techniques to other applications involving simulation of fluid flow. The results are better designs, lower risk and faster time to the market place for these processes. Immediate applications within our research group include numerical stability results for analytical and discrete velocities profiles.

## Financed through/by

Romanian National Authority for Scientific Research, CNCS - UEFISCDI, project number PN-II-RU-PD-2011-3-0153, 31/ 5.10.2011.

## Research team

Lect. Univ. Dr. Florica Ioana Dragomirescu;  
Prof. Univ. Dr. Ing. Romeo Susan-Resiga.

## Contact information

Assist. Prof. Ioana DRAGOMIRESCU, PhD  
Department of Mathematics  
Address: P-ta Victoriei, No.2, RO300006, Timisoara  
Phone/Fax.: (+40) 256 403 098  
E-mail: ioana.dragomirescu@upt.ro



## RANDOM MATRIX TECHNIQUES IN QUANTUM INFORMATION THEORY (RMT QIT)

### Goal of the project

Quantum Information Theory (QIT) is a recent and rapidly developing field, originating in physics, whose significance ranges from fundamental issues in quantum theory to new state-of-the-art methods for secure transmission of information. Quantum information theory is a multi-faceted field, with a multitude of mathematical connections. Our project focuses on the exploration of the open question from QIT using tools from random matrix theory.

### Short description of the project

RMT QIT project is built around a new and ambitious idea: to use random matrix techniques to solve big open problems in QIT. Although recent developments in QIT represent excellent progress, many major problems remain and substantial opportunities have arisen. The aim of our project is to explore and provide answers for questions in QIT about random quantum states and quantum channels. Such problems have appeared in the last decade very naturally in connection to fundamental issues in the theory, such as entanglement theory and classical (or quantum) capacities for channels. Since explicit answers for non-trivial dimensions are hard to give, physicists and computer scientists turned to typical states and channels, that is random states or channels. These examples proved to be very rich and they were the key ingredient to some very spectacular results, such as the non-additivity of the Holevo quantity for quantum channels or thresholds for the entanglement of typical quantum states.

### Project implemented by

In Romania the project is implemented by The Department of Mathematics, Politehnica University of Timișoara and, in France, by Laboratoire de Physique Théorique de Toulouse, Université Paul Sabatier Toulouse III.

### Implementation period

1st March 2013–29th February 2016

### Main activities

RMT QIT project goals three main problems. The first task is Random quantum channels: capacities and their image. It is of interest to study the Minimum Output Entropy (MOE) of a random quantum channel and to understand how big can be the violation of the additivity of MOE. The second task is Typicality of entanglement in large quantum systems.

The key problems here are the understanding of the statistical properties of random quantum states. We would like to analyze new models of randomness and problems related to multipartite entanglement. The third task is Random positive maps between matrix algebras. We want to construct large ensembles of positive maps, using the criteria for complete positivity known from QIT, by requiring that the criteria for complete positivity should be violated.

### Results

Our project has an inter-disciplinary character and this is one of its main advantages, its results interesting both mathematical and physical communities. The results obtained so far in are the followings:

1. M. A. Jivulescu, N. Lupa, I. Nechita, On the reduction criterion for random quantum states, to be submitted
2. Serban T. Belinschi, Benoit Collins, Ion Nechita - Almost one bit violation for the additivity of the minimum output entropy - arXiv:1305.1567
3. Daniel Braun, Olivier Giraud, Ion Nechita, Clement Pellegrini, Marko Znidaric - A universal set of qubit quantum channels - arXiv:1306.0495

### Applicability and transferability of the results

Results of the research activity will be published in journals of specialty. The members of RMT QIT project will also present their results at the major international scientific conferences and workshops in the fields of Quantum Information Theory, Mathematical Physics and Random Matrix Theory.

A website of the project is established: <https://sites.google.com/site/rmtqit2013/>.

It is maintained up-to date with all the information about the state-of-the-art of the project (the project goals and a database of all publications that will be thus made freely available to the public).

## Fields of interest

Quantum Information Theory, Mathematical Physics, Random Matrix Theory

## Financed through/by

Unitatea Executivă pentru Finanțarea Învățământului Superior, a Cercetării, Dezvoltării și Inovării (UEFISCDI), Romania and L'Agence Nationale de la Recherche (ANR), France

## Research team

Lecturer Dr. Maria Anastasia Jivulescu, head of the team from Timișoara

Dr. Ion Nechita, head of the team from Toulouse

Assist. Dr. Nicolae Lupa, research assistant at Timișoara

## Contact information

Assist. Prof. Maria Anastasia JIVULESCU

Department of Mathematics

Address: P-ta. Victoriei, No 2, RO300006, Timisoara

Phone: (+40) 256 403 098

Mobile: (+40) 740 517 340

Fax: (+40) 256 403 109

Email: maria.jivulescu@upt.ro

Web: <http://www.mat.upt.ro/>, <https://sites.google.com/site/rmtqit2013/>

## RESGAS2011: RESEARCH FOR BIOGAS PRODUCTION AND SUITABLE RENEWABLE ENERGY CARRIER

### Goal of the project

The main objective of the project is to perform research and development activities in support of innovation in the field of biogas production. A major shift in the energy policy of both countries could only come from updated technologies, together with best practice exchange. The partners identified possible improvements of the biogas production in both liquid and solid phase, based on different input materials.

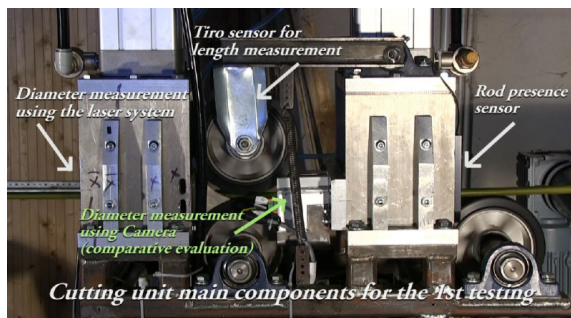

### Short description of the project

By the end of the project, the partners will have undertaken several joint research projects aiming at providing added value for the field. The goal is to connect technology, policy, industry, education, finance and public services in order to increase the understanding of the challenges brought by the immense consume of energy, combined with the limited character of the resources. This can be an opportunity for fundamental change in the way the world produces and consumes energy. The synergy between the project partners has a multiplication effect on both sides of the border.

### Fields of interest

The main fields of interest connected with the project applicability and implementation are: biotechnology (analytical characterisation for the chosen substrates); overall characterisation of process in regards to anaerobic fermentation general parameters (temperature, pH, produced quantities, partial composition of biogas in terms of methane and CO<sub>2</sub> percentages); ways of potentially optimize biogas production both in terms of the used materials and process control.

### Project implemented by

Research centre for Thermal Machines and Equipment, Transportation and Pollution Control of UPT, in partnership with the University from Szeged, USAMVB Timișoara and Alapítvány Foundation from Szeged..

### Main activities

Studies connected with fermentation of pre-treated and hydrolyzed biomass as way to increase the biomass conversion ratio and energetic capitalization of biogas. Based on the previous detailed investigations appropriate suggestions will be made on the use and monitoring of the proper microbiological community to be employed for the anaerobic digestion of various organic waste substrates. Methods will be optimized and recommended for the characterization of the biogas production technologies from a microbiological point of view and interested users will be educated to carry out the necessary tests.

Recommendations were formulated for the future advancement of the biogas biotechnology, such as the large scale production of the key microbes and enzymes to be employed.

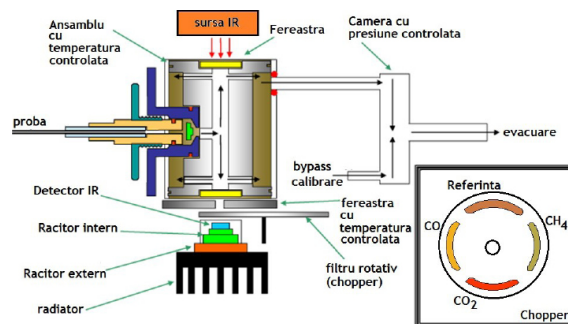

### Implementation period

01.06.2012-30.11.2013

### Research centre

Research centre for Thermal Machines and Equipment, Transportation and Pollution Control

## Results

- Study regarding & Technological description for the energetic capitalization of biogas;
- Integrated biogas technology description provided for a number of applications;
- Testing different substrates at small scale and inside a pilot installation;
- Report concerning the fermentation of pre-processed biogas of novel biogas improvement technologies;
- Joint book with CD covering the main experimental results of the project and the achieved reports, as well additional theory.

The main results of the joint scientific activity belong to the public domain and were already and will continue to be published in recognized international scientific journals by the Partners and will be presented at domestic and international conferences. Training in modern molecular biology techniques were carried out. The final results and conclusions over the undertaken activities and a final report were delivered.



## Financed through/by

Hungary-Romania Cross-Border Co-operation Program 2007-2013 ([www.hurocbc.eu](http://www.hurocbc.eu)) and is part-financed by the European Union through the European Regional Development Fund, Hungary and Romania, Action 2.2.2. Realization of joint research projects, contract id HURO/ 1001/193/2.2.2.

## Research team

UPT team:

Prof. Dr. Ing. Ioana Ionel  
Dr. Ing. Adrian Eugen Cioabla  
Dr. Ing. Laurențiu Călin  
Dr. Ing. Ramon Balogh  
Dr. Ing. Daniel Bisorca  
Dr. ing. Delia Călinoiu  
Ec. Iris Mihai



USAMVB team:

Ș.I. dr. Vintila Teodor  
Dr. ing. Neo Simina

Szeged University and Alapítvány Foundation from Szeged team:

Prof. Dr. Kornél L. Kovács  
Dr. Zoltán Bagi  
Peter Heffner

## Applicability and transferability of the results

The results obtained during the joint research project can be further tested and potentially applied (after thorough consideration) inside semi – industrial or low scale installations for determining the real potential of the different types of materials used for obtaining biogas.

## Contact information

Prof. Ioana IONEL, PhD  
Department of Mechanical Machines, Equipment and Transportation  
Address: Bd. Mihai Viteazu, No. 1, RO300222, Timisoara  
Phone/Fax: (+40) 256 403 670  
E-mail: [ioana.ionel@upt.ro](mailto:ioana.ionel@upt.ro)  
Web: <http://www.mec.upt.ro/resgas2011>

## SUSTAINABLE DEVELOPMENT OF A RESEARCH CENTER IN BANAT REGION AND DANUBE FLOW AREA THROUGH SCIENTIFIC RESEARCH AND ENVIRONMENTAL SIMULATION TOOLS TO ASSESS AND EVALUATE POTENTIAL THREATS.

### Goal of the project

Main project objectives are: strengthening the cross-border cooperation between Banat Universities; evaluating the environmental quality (air & water) in the Banat and Danube flow area; protection of regional environment by means of identification of the pollution risk; increasing the importance of R&D in cross-border area; creation of 2D and 3D area pollutants dispersion maps for the BANAT region and Identification of the high polluted hot-spots in the Banat region; dissemination of know-how.

### Short description of the project

The project activities are structured in two stages. In the first stage the necessary air and water quality monitoring equipment will be acquired on both universities, knowledge will be disseminated and learned "by doing", the set-up will be conducted in Zrenjanin and Timisoara and joint Romanian-Serbian scientist's team will collect the water samples from main Danube tributaries and major Banat rivers. The second stage of the project will be focused on knowledge transfer and scientific research and dissemination of results.



### Project implemented by

Francisc Popescu

### Implementation period

12.06.2013 – 11.06.2014

### Main activities

Project start-up, planning and development; Equipment acquisitions; Dissemination (workshop, conference, media, book); Data acquisition and field samples collection; Creation of iso-concentration maps.

### Results

Acquisition of high resolution equipment's for air and water quality monitoring and necessary software for simulations and creation of pollutants iso-concentration maps; Intensive training of students and Serbian scientists in use of Lagrangian and Gaussian models for air pollutant dispersion; an academic database with all resulted iso-concentration maps for Banat region; dissemination workshops and book.

### Applicability and transferability of the results

The main core result of the project is the creation of an extensive database (envirobanat.ro) with water quality measurements in Banat area and Danube flow tributaries, main air pollutants concentrations, reports and guide's that will be available for further analysis for academic scientists, students, policy makers.

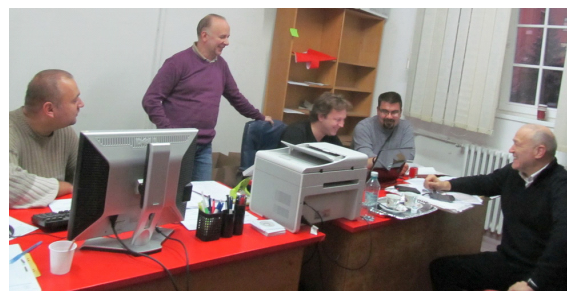



## Fields of interest

Air quality monitoring, water quality monitoring, spectrophotometry, light scattering – particle sizing, aerosols, environmental protection.



## Research centre

Research centre for Thermal Machines and Equipment, Transportation and Pollution Control

## Financed through/by

EU Commission, Romania-Republic of Serbia IPA Cross-Border Cooperation Programme, Measure 1.4 - Support increased levels of R&D and innovation in the border region.

## Research team

Francisc Popescu  
Dorin Lelea  
Ioan Laza  
Gavrilă Trif-Tordai  
Adrian-Eugen Cioabla  
Olivia Bundău  
Marinela Balut  
Gavril Brateanu



## Contact information

Assist. Prof. Francisc POPESCU, PhD  
Department of Mechanical Machines, Equipment and Transportation  
Address: Bv. Mihai Viteazu, No.1, RO300222, Timisoara  
Phone: (+40) 256 403 666  
Mobile: (+40) 721 832 730  
E-mail: francisc.popescu@upt.ro  
Web: envirobanat.ro

## AUTOMATIC HARVESTING SYSTEM FOR SRC NURSERIES - ROD-PICKER

### Goal of the project

The main objective of the project is to provide the newest development in SRC harvest technology. The ROD - PICKER prototype will be developed as an automatically working, harvesting, sorting and packaging system, thus greatly reducing the needed manpower and costs for harvesting SRC cutting in tree nursery quarters.

### Short description of the project

Biomass is increasingly being seen as an important energy resource for Europe. However, due to sustainability requirements the biomass which can be harvested from European forests has only a limited growth potential. Therefore, the political focus has changed to the production of fast growing biomass Short-Rotation-Coppice (SRC). In parallel, the economic situation for European farmers deteriorated during the last decade, due to increasing cost pressures on agricultural products, especially energy prices and ecological control. SRC are a very promising alternative source of income, as a sustainable and continuous source for bio-energy generation. SRCs are highly efficient biomass production systems, with additional environmental contributions such as biodiversity, soil protection and local climate.



In order to reach the political climate protection targets Europe would need more than 4,2 million hectares of Short-Rotation-Plantations by 2030. To cover the corresponding demand of planting material approximately 1,410 hectares of tree nurseries have to be produced each year. Harvesting on these areas is carried out during the winter months only and is characterized by a high degree of manual work presently. Automatic and cost-efficient harvesting techniques for SRC cuttings are urgently needed to meet the future demand economically. Based on this background the SME proposers are planning to develop, construct and test an automatic harvesting and sorting system for SRC cuttings.

### Project implemented by

A multidisciplinary team covering mechanical, computational, electronic engineering from UPT (at the initiative of the Research centre for Thermal Machines and Equipment, Transportation and Pollution Control), in partnership with EGEDAL MASKINFABRIK A/S from Denmark (project coordinator), Salix Energi (Sweden), Lempe GbR (Germany), TU Dresden (Germany), and TTZ Bremerhaven from Germany.



### Main activities

- Determination of technical and economic requirements for the ROD-PICKER system;
- Development and design of the ROD-PICKER prototype;
- Construction and testing of the ROD-PICKER prototype;
- On-site testing and optimization of the ROD-PICKER prototype at tree nursery farm, monitoring and evaluation;
- Assessment the effects on environmental, social and economic sustainability of the developed ROD-PICKER system;
- Dissemination the project results for the later commercialization and exploitation of the ROD-PICKER system and system components





## Results

- ROD-PICKER concept for all modules and units development, using a novel concept;
- Prototype mechanization, automatization & control unit;
- Testing, analysis of results and retrofit of proposed solutions;
- Manual and dissemination materials.



## Implementation period

01.10.2012 - 30.09.2014

## Research centre

Research Centre for Thermal Machines and Equipment, Transportation and Pollution Control

## Fields of interest

Cutting, Sorting and Bundling – Prototype Unit for SRC nurseries.

## Financed through/by

European Union's Seventh Framework Programme managed by RES – Research Executive Agency.

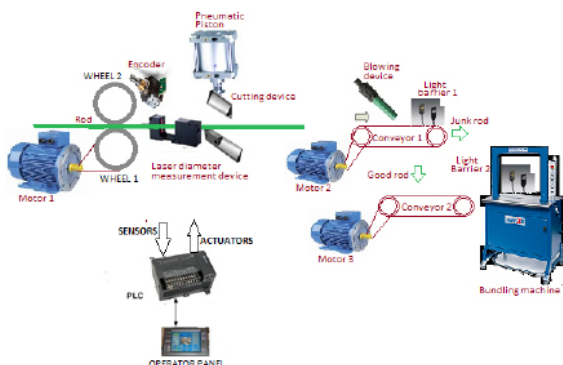

## Research team

. UPT team:

Prof. Dr. Eng. Ioana IONEL  
 Prof. Dr. Eng. Dumitru TUCU  
 Prof. Dr. Eng. Sorin NANU  
 Assoc. Dr. Eng. Daniel DAN  
 Assoc. Dr. Eng. Mircea VASILESCU  
 Lect. Dr. Eng. Luisa Izabel DUNGAN  
 Lect. Dr. Eng. Raul Ciprian IONEL  
 Lect. Dr. Eng. Ciprian DUGHIR  
 Dr. Eng. Dumitru CEBRUCEAN  
 Dr. Eng. Laurentiu CALIN  
 Dr. Eng. Ramon BALOGH  
 Dr. Ion VETRES  
 Dr. PhD. Alexandru SMARANDA  
 Eng. Zoltan SZUCS  
 Eng. Gavril BRATEANU  
 Gheorghe-Nicolae SOSDEAN  
 Horia-Ionut POP  
 Claudiu-Andrei BOTA  
 ec. Simona FILIPAS  
 ec. Marilena BALUT

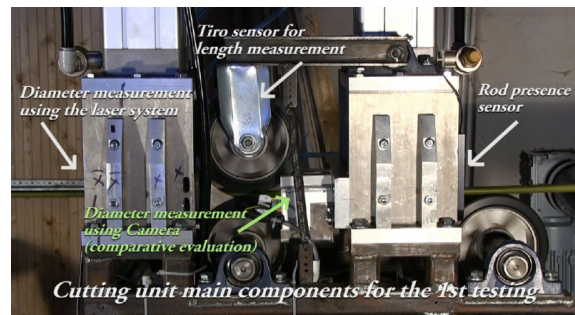

## Applicability and transferability of the results

Production of the prototype for sorting, cutting and packaging the SRC cuttings

## Contact information

Prof. Ioana IONEL, PhD  
 Department of Mechanical Machines, Equipment and Transportation  
 Address: Bd. Mihai Viteazu, No. 1, RO300222, Timisoara  
 Phone/Fax: (+40) 256 403 670  
 Mobile: (+40) 723 349 337  
 E-mail: ioana.ionel@upt.ro  
 Web: <http://rod-picker.eu/>

## NOVEL TOOL FOR URBAN AIR QUALITY MONITORING – AIRQ

### Goal of the project

- to parameterise some particular mechanisms of turbulent mass and momentum transfer that are likely to happen in specific urban forms named hereafter street-half-canyon. Those mechanisms are not addressed by the current models;
- to introduce that parameterisation in an existing air quality model used for regulatory purpose in France, SIRANE, so as to make this code able to address the question of industrial emissions in densely populated areas located directly around city centres;
- to investigate the responses given by the model with emissions cadastre of different resolutions. That point is of particular interest to evaluate the quality of the simulations when traffic data remain poorly documented (current situation for several European Union members);
- to validate the new version of SIRANE with real life data provided by measurements taken in an urban environment submitted to industrial emissions;
- to apply SIRANE for the city of Timișoara.

### Short description of the project

Air quality is a pressing issue, especially in high population density areas, where several sources of pollutant emissions can result in exceeding the limits imposed on admissible concentrations. Environmental laws stipulate acceptable levels of pollutant concentrations, as well as the number of allowed instances where concentrations are higher than imposed maximum limits, within one year timeframe. If an European Union member reports too many cases when pollutant concentrations exceed imposed limits, the infringement procedure can be triggered, with severe penalties for local authorities. The project is the cooperation between France and Romania. The main goal of the research team in France is to investigate the turbulent mechanisms responsible for dispersion over street-half-canyon, to develop the new module for the dispersion model, to provide an adapted methodology for the building of an emission cadastre, to configure the dispersion model for a specific domain of Timișoara, and to provide the results for the specific case of the city of Timișoara. The team in Romania provides the data required for running the software and perform measurements for validation of the calculated data. Expected results include an environmental cadastre of emissions, including anthropogenic and natural pollution sources. Three dimensional maps of pollutant species concentrations would be available as a result of the research developed in this project. The novel version of SIRANE developed during the project would allow decision factors to identify the most likely reason for exceeding imposed limits. Also, based on the results provided by this new tool, a better urban planning would be possible, and a higher air quality can be ensured.

### Implementation period

03.01.2012-30.12.2014



### Main activities

- parameterization of turbulent mechanisms responsible for pollution dispersion in specific urban forms;
- implementation of that parameterization in an existing urban air quality model;
- validation of the entire modeling chain by measurements in the city of Timișoara;
- quantification of uncertainty in the results resulting from the quality of the emission cadastre;
- development of a warning system that identifies episodes of exceeding imposed concentrations limits;
- development of improved urban planning strategies.

## Financed through/by:

UEFISCDI (Unitatea Executivă pentru Finanțarea Învățământului Superior a Cercetării Dezvoltării și Inovării), as Ideas, in cooperation with ANR (Agence National de Recherche), as a Blanc International II project.

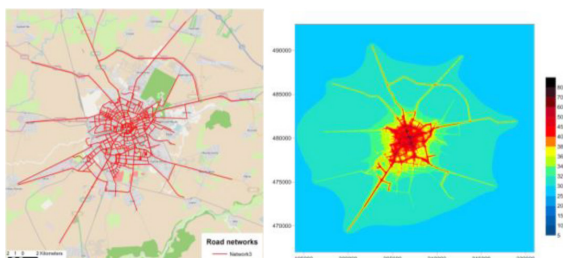

## Project implemented by

Politehnica University of Timisoara (€240,000), in partnership with École Centrale Lyon and NUMTECH from France (€258,245).



## Research centre

Research Centre for Thermal Machines and Equipment, Transportation and Pollution

## Results

A new dispersion model, new air quality monitoring tool for urban air quality, database containing pollutants concentrations.

## Research team

Prof. Dr. Eng. Ioana IONEL  
Lect. Dr. Eng. Luisa Izabel DUNGAN  
Dr. Eng. Nicolae LONTIS  
Dr. Eng. Ion VETRES  
Dr. Phys. Delia CALINOIU  
Phys. Doina NICOLAE  
Camelia TALIANU  
Silviu MEGAN  
dr. Ramon BALOGH  
lect. dr. ing. Dan STEPAN

## Applicability and transferability of the results

Authorities, research for the urban development, air quality control, traffic analysis, corrective measures for existing infrastructure, epidemiologic and social analysis, etc.

## Contact information

Prof. Ioana IONEL, PhD  
Department of Mechanical Machines, Equipment and Transportation  
Address: Bd. Mihai Viteazu, No. 1, R0300222, Timisoara  
Phone/Fax: (+40) 256 403 670  
E-mail: ioana.ionel@upt.ro  
<http://mec.upt.ro/airq/>

## CONTRIBUTION TO SUSTAINABLE DEVELOPMENT BY ASSESSING THE TRANSBOUNDARY AIR POLLUTION UPON THE CULTURAL&TURISTICAL HERITAGE IN HU - RO BORDER - TRANSAIRCULTUR

### Goal of the project

Protection of cultural regional heritage by means of a novel scientific tools consisting of identification of the pollution risk.

### Short description of the project

Transboundary pollution is a natural phenomena, specific to vicinity regions, generated by national sources, under the influence of shared climate. The specific target regions (two counties) share the footprint of both nations and are of joint interest concerning raising the environmental awareness. The project demonstrates that a high level of environmental performance provides a long term competitive advantage, as it is focusing on establishing of the cross border pollution impact assessment versus the cultural & touristy natural heritage.



### Main activities

Cultural, architectural & touristy sites identification in Timis/Csongrad area - identification and recording of important/relevant sites belonging of the cultural, architectural and touristy cross-border heritage; In-situ air quality monitoring campaigns in order to establish by direct pollutant concentration measurements (CO, NOx, SO2, O3, PM10 and VOC) the site air pollution and possible risks; Simulations/predictions of air pollutants impact on cultural/architectural/touristy sites.

### Project implemented by

The Department for Mechanic Machines, Equipment and Transportation from UPT in partnership with University of Szeged from Hungary and Diaspora Foundation from Romania.

### Results

Action plan needed for both counties, Timis and Csongrád, and include cultural and architectural sites from both parts of the border; iso-concentration charts/maps were achieved for both counties, for the first time, including specific important sides on it, targeting the trans-boundary impact, as well of common interest.

### Research centre

Research Centre for Thermal Machines and Equipment, Transportation and Pollution Control

### Financed through/by

Hungary-Romania Cross-Border Co-operation Program 2007-2013 ([www.hurocbc.eu](http://www.hurocbc.eu)) and is part-financed by the European Union through the European Regional Development Fund, Hungary and Romania.

### Research team

UPT team:

Prof. Dr. Eng. Ioana IONEL;

Prof. Dr. Eng. Sevastean-Ioan IANCA;

Lect. Dr. Eng. Francisc POPESCU;

Lect. Dr. Eng. Luisa Izabel DUNGAN;

Assist. Dr. Olivia-Mihaela BUNDAU;

Dr. Eng. Nicolae LONTIS;

Dr. Eng. Ion VETRES;

Eng. BRATEANU Gavril.

### Implementation period

01.04.2012 - 31.03.2013

### Contact information

Prof. Ioana IONEL, PhD

Department of Mechanical Machines, Equipment and Transportation

Address: Bd. Mihai Viteazu, No. 1, RO300222, Timisoara

Phone/Fax: (+40) 256 403 670

E-mail: [ioana.ionel@upt.ro](mailto:ioana.ionel@upt.ro)

## IMPROVEMENT OF LIFE QUALITY IN CHILDREN WITH CYSTIC FIBROSIS BY THE IMPLEMENTATION OF A NEW STRATEGY REGARDING PHYSICAL THERAPY BASED ON INCENTIVE TECHNIQUES AND INDIVIDUALIZED PHYSICAL TRAINING

### Goal of the project

In terms of research, the project aims to increase the quality of life for young Romanian people with CF by implementing a new strategy based on physical therapy and incentive techniques. The goals are:

- Creating a research program that aims to optimize physical therapeutically intervention in patients with cystic fibrosis,
- Building an interdisciplinary team,
- Validation of a complex physical therapy protocol,
- Increase the international visibility of the research team and UPT.

### Short description of the project

We believe that by developing a protocol based on the combination of incentive techniques, respiratory clearance techniques, and individual physical training, we will increase the quality of life. We conducted a study lasting 25 months which will include 40 subjects aged between 14 and 18 years, diagnosed with CF and whom have the agreement of their legal gardiens to participate in this research project. subjects will be randomly assigned into: groups (study) - they will make individualized physical training based on the modern technologies available in the project (multi-bio-impedantometry, dynamometer, myotest systems and monitoring heart rate with pulsmeters); incentive therapy techniques (using device Trainair) and respiratory clearance; and group c (control)- they will follow standard physical therapy programs conducted in the national center for CF, with no incentive therapy techniques. the initial evaluation will be followed by reassessment of the same parameters at 6, 12 and 24 months. The design and monitoring of physical therapy programs will be based on data provided by the initial assessment and re-evaluations during the semester.

### Project implemented by

UEFISCDI and University Politehnica of Timisoara

### Implementation period

01.08.2010-31.07.2013

### Main activities

Assessment of the patients: somatometric examination and evaluation of body composition by multifrequent impedantometry, determination of maximum muscle force, the evaluation of flows, volumes and rest capacities of the lung, evaluation of the life quality, evaluation of maximum breathing pressure and respiratory muscle training  
Design and monitoring of physical therapy programs;  
Statistical analysis and interpretation of data;  
Participation at international and national conferences;  
Publishing the articles and books;  
Lecturers at different conferences, organizing conference;  
Implementing the protocol into the hospitals and in Romanian National CF Center.

### Results

- 1 ISI article with impact factor;
- 5 ISI proceedings;
- 6 international data base;
- 1 monography;
- Award received by UEFISCDI and UPT for the paper: Artificial intelligence techniques: an efficient new approach to challenge the assessment of complex clinical fields such as airway clearance techniques in patients with cystic fibrosis.

### Applicability and transferability of the results

Protocol implemented at Romanian National Cystic Fibrosis Center  
Transferability of the results to all the patients from Romanian National CF Centre

Recognition by the Romanian Cystic Fibrosis Association  
Monography published which becomes the gold standard in CF physiotherapy treatment in Romania.

### Fields of interest

- Sport and Physical Education
- Physiotherapy
- Medical
- Adapted Activities for Persons with Special Needs

### Financed through/by

UEFISCDI; PN II, Human Resources, Research projects for young independent teams of research.

### Research team

Bogdan Almajan-Guta- Project Director  
Claudiu Avram  
Ornela Cluci  
Alexandra Rusu

### Contact information

Assist. Prof. Bogdan ALMAJAN GUȚA, PhD  
Department of Physical Education and Sports  
Address: Bd. Mihai Viteazu, No.2, RO300223, Timisoara  
Mobile: (+40) 722 723 537  
E-mail: bogdan.almajan-guta@upt.ro



## TAF CITY – THE AGE FRIENDLY CITY

### Goal of the project

The project brings public and private sector agencies and enterprises together to address the needs of an ageing population and improve the services and opportunities for social cohesion within the urban environment, bridging public authorities/municipalities responsible for policy and planning and private enterprise, with the need to train enterprises and employees in new skills that meet the needs of an ageing population. This need is met with the development of the TAF CITY course which addresses ageing strategies and provision of service for all.

### Short description of the project

The project builds on the results and experiences from 2 other projects: TACTALL and ViCaDiS. It brings together the TACTALL delivery methodology and learning resources promoting accessibility within tourist enterprises and the new learning technologies incorporating social and ICT tools developed by ViCaDiS.

ViCaDiS offers an open resource environment and tools allowing learners to learn and work together using Wiki, blog, forum, podcasting, instant messaging, conferencing, mobile learning.

TACTALL project built a training programme addressing the issues of Accessibility, whereby the future needs of the increasing numbers of people with functional diversity might experience a better quality of service. It concluded that existing networks such as the World Health Organisation offered a practical opportunity to embed its learning programme, whilst ViCaDiS has the potential to meet the needs of Business enterprises, employees, adult learners, unemployed and Vocational Training actors.



### Implementation period

01.10.2011 – 31.09.2013

### Project implemented by

Politehnica University of Timisoara, Romania  
CDEA San Sebastian, Spain  
Norton Radstock College, UK  
Euro Contact Business School, Budapest, Hungary  
Matia Innova, Donostia, Spain  
INSIGNARE Ourem, Portugal  
EFVET Brussels, Belgium  
SSGT Maribor, Slovenia

### Main activities

- Research and analysis of the training needs: done with target groups, business enterprises & employees, vocational education teachers
- Development of the training tools: done based on previous projects' results – Virtual Campus for Digital Students (ViCaDiS platform, developed by UPT) and TacTall course (developed by CDEA)
- Adoption of the e-learning platform
- Development of the TAF City course (learning resources, session plans, scheme of work)
- Test of the pilot, with the relevant target groups
- Evaluation of the "Age Friendly" product (by participants and by teachers) in order to assess sustainability and viability
- Dissemination to policy makers, municipalities, VET providers, SME, organisations working with older people
- Development of the TAF City course as a sustainable product



## Applicability and transferability of the results

The project enables partners to share and exchange ideas about developing age-friendly cities and broaden the ideas and practices available. It is felt that communities can be strengthened and economies developed across Europe.

Added value comes in the form of training products that can be shared and customized across the partnership resulting in wider use and economy of scale.

The development of a sustainable online Age-Friendly community will support the further exploitation of the Age-Friendly City product across Europe. Sharing good practice and different perspectives allows all to benefit.

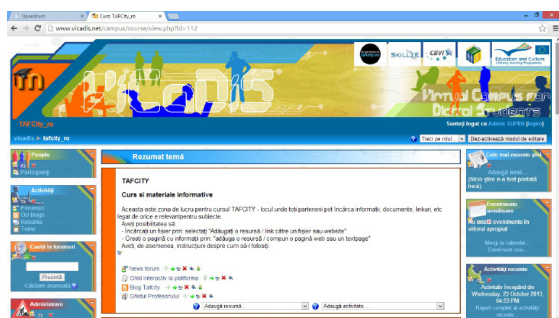

## Fields of interest

Age friendly concept, growth of urban older generation, social inclusion through municipality behavior, friendly city for different categories of citizens, solidarity, accessibility for all generations, age friendly city networks, improving quality of life, e-learning, training for delivering age friendly cities, social educational tools.

## Financed through/by

EACEA – Education, Audiovisual and Culture Executive Agency, Lifelong Learning Programme, Transfer of Innovation

## Research centre

Center for eLearning



## Results

- Needs Analysis Survey: conducted in all partner countries, identified the primary needs of the target groups;
- Individual country report on training needs;
- Specific Web 2.0 (social media) tools, integrated in the ViCaDiS platform, the Virtual Campus of UPT;
- Teacher guide for the TAFCity course;
- Pilot course evaluation following pilot courses in all partner countries;
- Recommendations for changes following pilot course;
- Dissemination and Valorisation Plan;
- Promotional materials (brochures, presentations, press releases, newsletters, conferences, research papers);
- Sustainability Report;
- Quality Management and Assurance Plan;
- External Evaluation Report.

## Research team

Diana Andone  
 Radu Vasiu  
 Vlad Mihaescu  
 Mihai Onita  
 Andrei Ternauciu  
 Silviu Vert

## Contact information

Diana ANDONE, PhD  
 Center for e-Learning  
 Address: Bd. Vasile Pârvan, No. 2, RO300223, Timisoara  
 Phone/Fax: (+40) 256 403 300  
 Email: [diana.andone@upt.ro](mailto:diana.andone@upt.ro)  
 Web: <http://elearning.upt.ro/>, <http://elearning.upt.ro/proiecte/eu/tafcity/144> <http://www.tafcitu.eu/>



## Research-Adjacent Projects

Field	Total number of projects	Source of financing	Number of projects
Systems Engineering	1	Structural Funds	1
Electronics and International Telecommunication Engineering	1	Structural Funds	1
Learning	7	Structural Funds	7



## DRIVING COMPETITIVENESS OF ENTERPRISES THROUGH TRAINING AND SPECIALIZATION OF HUMAN RESOURCES NEW TECHNOLOGIES IN A KNOWLEDGE-BASED SOCIETY AND DEVELOPMENT SUSTAINABLE

### Goal of the project

The overall objective is to develop a system directed towards supporting adaptability of industrial enterprises and those in the service industry, the new requirements of the knowledge economy, for: - providing and updating skills necessary for employees holding positions of technical and technological innovation and / or Research Development,

- training in advanced technology entrepreneurs, managers and employees directly involved in the design/development in sectors competitive with high grow.

### Short description of the project

The project aims to promote a positive attitude towards entrepreneurship in the region through development V-S-V improvement activities and supporting human 's resources, managerial and entrepreneurial skills. Actions aim is to increase competitiveness, performance and profitability.

Action will be the support, guidance, and offer consulting and training activities new innovative entrepreneurs for the creation and consolidation of new businesses in developing regions V-S-V. There will also be targeted and interregional and transnational activities to promote entrepreneurial culture.

Target groups

- entrepreneurs, managers and employees of small and medium-sized enterprises
- local suppliers, training and retraining programs
- contractors who founded a business and / or will to manage their business
- employees who have completed retraining programs .

### Project implemented by

Polytechnic University of Bucharest

Politehnica University of Timisoara

Technical University of Cluj-Napoca

University "Gheorghe Asachi" Iasi

Design Institute for Automation Bucharest,

Chamber of Commerce and Industry Buc.

INT EROP-VLAB from France

### Implementation period

July 2010- June 2013

### Main activities

1. Conducting training programs in a pilot mode.
  - 1.1 Conduct training programs in the pilot module, the methodology set.
  - 1.2 Evaluation of the results obtained in following completion of the pilot module, developed previously.
  - 1.3 Improving methodology and training programs as assessment results.
2. Activities of providing training programs, according to the results of previous activities and optimizations in the RNCFPS, current activities CNFPS maintenance and development.
3. Activities - support advice and assistance to members of specific target groups trained to ensure internal reorganization processes correlated with the introduction of the latest technologies in ICT, automation and knowledge management and developing an electronic library to support the information on the scale.

ID	Indicatori [1 output]	Valoare
306	Numărul cursurilor în management și organizarea muncii	200
307	Numărul cursurilor în management și organizarea muncii, din care: femei	100
308	Numărul cursurilor pentru actualizarea și îmbunătățirea competențelor	1800
309	Numărul cursurilor pentru actualizarea și îmbunătățirea competențelor, din care: medii	0
310	Numărul cursurilor pentru actualizarea și îmbunătățirea competențelor, din care: asistente	0
313	Număr de participanți la instruire - formare profesională continuă	0
314	Număr de participanți FSE - femei	400
315	Număr de evenimente de comunicare și promovare - formare profesională continuă	0
316	Numărul cursurilor de formare profesională cofinanțate	100
317	Numărul cursurilor de formare profesională cofinanțate, dintre care: în TIC	80
318	Numărul cursurilor de formare profesională cofinanțate, dintre care: în probleme legate de mediu	6
319	Numărul cursurilor de formare profesională cofinanțate, dintre care: în probleme legate de sănătate și securitate	0

### Fields of interest

According to EU documents, each Member State is required to contribute to the joint space by establishing a support strategy in research, technological development and innovation. National Network of Centres of specific training, created in the project, is one such framework.

## Results

- national collaborative network of experts in new ICT technologies, Advanced Automatic and knowledge management
- electronic library nationwide, according to the results of interrelated activities
- national study to identify the specific needs of target group members
- National Training Center network specifications and Regional Centers specific training
- Web portal to facilitate development of collaborative working training programs for communication between network members
- one catalog consists of a total of 100 courses in classical and eContent organized in flexible programs developed and oriented to specific training of human resources involved in research, innovation, design, development, entrepreneurship and offer ICT services, advanced automation, knowledge management.

## Applicability and transferability of the results

One purpose of the Romanian National Reform Programme is to promote the competitiveness of industrial enterprises as well as those in the service industry. Features of any competitive companies with sustainable development should include:

- Adaptability and dynamic macro and micro context change;
  - Forecasting and opportunity management techniques and systems introduction intelligent supervision, management and optimization of processes with IT support;
  - Ability to continue education of all groups of employees.
- This project develops these traits.

## Financed through/by

EUROPEAN SOCIAL FUND

Sectoral Operational Programme Human Resources Development 2007 - 2013

Priority axis no. 3 "Increasing adaptability of workers and enterprises"  
Key Area of Intervention 3.2 "Training and support for enterprises and employees to promote adaptability"

Romanian - POSDRU /81/3.2/S/53084

## Research centre

Research Centre for Automatic Systems Engineering (CCISA)



## Research team

Prof.dr.ing. Ioan SILEA -coordinator

As.dr.ing. Octavian ST EFAN

S.I.dr.ing. Adrian BUT

Prof.dr.ing. Toma-Leonida DRAGOMIR

S.I.dr.ing. Petrica DORINA

Assoc.prof.dr.ing. Florin DRAGAN

As.ing.drd. Emil VOISAN

## Contact information

Prof. Ioan SILEA, PhD

Assist. Octavian STEFAN

Department of Automation and Applied Informatics

Address: Bv. Vasile Pârvan, No. 2, RO300223, Timisoara

Phone: (+40) 256 403 247

E-mail: ioan.silea@upt.ro

E-mail: octavian.stefan@upt.ro

Web: <http://www.comhightech.ro/>

## 4D-POSTDOC – DEVELOPMENT AND SUPPORT FOR POSTDOCTORAL MULTIDISCIPLINARY PROGRAMMES IN PRIORITY TECHNICAL FIELDS ACCORDING TO THE NATIONAL RESEARCH–DEVELOPMENT–INNOVATION STRATEGY

### Goal of the project

The main objective of the project is to increase the quality of the management for postdoctoral research projects in the three involved universities. The aim is to develop human resources involved in research, with the view of economic growth and creation of the knowledge based society. The project financially supports young researchers, in order to increase integration in the European Research Space and economic competitiveness by applying innovative technologies resulted from applied research.

### Short description of the project

Specific objectives:

- Increase of the participation rate of the experienced researchers in developing a career in research in technical fields; the aim is to increase financial support for working, researching, publishing and to offer a better research infrastructure;
- Improvement of the postdoctoral research programmes, in: number of researchers, number of priority research subjects, quality of outcome publications;
- Improvement of the access to the research infrastructure, through co-operation with universities and research institutes in the EU;
- Improvement of the postdoctoral research programmes' management in the three partner Romanian universities;
- Financial support for 16 postdoctoral researchers in UPT, for their research (including periods abroad) and for their participation to international conferences;
- Increase of the research results visibility through publication in the main stream of international journals and conferences.

### Main activities

- Development of a framework for selecting the target group of researchers to be financed, based on competition;
- Institutional building for managing the postdoctoral programs in the 3 partner universities;
- Financial support for the selected researchers, through monthly research grants (maximum 1000 Euro/month, during 34 months);
- Financial support for researchers' participation to international research conferences, symposiums, seminars, congresses taking place within the EU space;
- Additional monthly financial support during the research periods spent abroad in research centers/institutes or universities from EU;
- Tutoring and scientific guidance for researchers;
- Development of a training/specialization program in specific research topics;
- Dissemination within 3 project conferences.

### Results

- 16 researchers from UPT selected;
- Financial support for 15 researchers (one has withdrawn after 3 months, due to family problems);
- 70 published research papers in different international journals, by the UPT researchers;
- 48 presented research papers to different international conferences, by the UPT researchers;
- 53 ISI publications by the UPT researchers;
- 15 agreements with industrial companies for transferring research results;
- 17 agreements signed with EU research institutions/universities for exchanging researchers and/or expertise;
- 15 research periods of up to 3 months spent in different EU research laboratories for conducting joint research.



### Project implemented by

Politehnica University of Timisoara  
Technical University Cluj-Napoca  
Technical University of Iasi

### Implementation period

01.04.2010 – 31.03.2013



## Applicability and transferability of the results

Management of modern postdoctoral research programs is a necessary ability for any university that intends to integrate itself in the European Research Area. The under-financing of the Romanian educational and research system created a gap between generations of researchers. The experience gained by this project in getting European support in organizing research programs, can be transferred to any other interested Romanian university. On the other hand, researchers' experience gained through the project already created cooperation links with researchers from other European research institutes.



## Fields of interest

Research projects' management, Romanian research infrastructure, European Research Space, Scientific Entrepreneurship, Scientific innovation, Technology transfer, Third Millennium engineering principles, Sustainable development through research, Green IT, Modeling systems with complex fluids, Modeling and simulating computer systems and networks.



## Research centre

Research Centre for Multimedia

## Financed through/by

European Social Fund, Development of Human Resources

## Research team

Radu Vasiu, Alimpie Ignea, Daniel Grecea, Nicolae Muntean, Vasile Gui, Lia Dolga, Carmen Grecea, Stefan Kilyeni, Dumitru Toader, Petru Andea, Flavius Surianu, Ioana Ionel, Liviu Marsavina, Marius Ottesteanu, Sorin Deaconu, Miranda Naforntita, Alexandru Isar, Liviu Anton, Ioan Jurca.

## Contact information

Prof. Radu VASIU, PhD  
Centre for E-learning/ Multimedia Research Centre  
Address: Bd. Vasile Pârvan, No. 2, RO300223, Timisoara  
Phone/Fax: (+40) 256 403 300  
Email: radu.vasiu@upt.ro  
Web: www.cm.upt.ro, <http://4dpostdoc.utcluj.ro>

## IS – SIMULATED ENTERPRISE FOR WORKING SKILLS IN TECHNOLOGICAL COMPANIES

### Goal of the project

The project aimed mainly at increasing the employability of university graduates in terms of training and development of the engineering practical skills required by employers, by developing and implementing an integrated information platform that simulates the real working technology companies and hiring specialists from these companies for students' practical training and for developing supporting materials. These goals were accomplished by using an innovative tool for Romanian higher education: simulated enterprise.

### Short description of the project

To implement the simulated enterprises it was established one laboratory in each partner University and tutors from the private sector were used to prepare students for the labour market through training, simulations and applied exercises. Subsequently, 240 students with outstanding results from a total of 600 learners benefited of internships in the companies.

At the Politehnica University Timisoara, the project was coordinated and managed by the Center for eLearning, with the support of the Faculty of Automation and Computers and the Faculty of Electronics and Telecommunications and with the involvement of 8 specialists from companies: OCE Canon, Continental Automotive Romania, HELLA, Flextronics Romania, ETA2U, Lasting Systems, Expert Consulting, MMD Design.

The project developed a methodology for conducting internship and student assessment that included instructional working methods, curricula for 90 hours, the assessment module and innovative use of ICT in the concept of virtual practice.



### Project implemented by

Ministry of National Education, Bucharest  
Politehnica University of Timisoara  
Politehnica University of Bucharest  
"Constantin Brancusi" University of Targu-Jiu  
Novensys Corporation, Bucharest  
Gold Agama Consulting, Bucharest

### Implementation period

01.04.2010 – 31.09.2013

### Main activities

1. Establish the administrative framework for project implementation;
2. Development of local/regional campaigns and workshops for promoting the project idea;
3. Selection of the technological companies willing to implement virtual internships;
4. Establish the requirements and development of the software application for virtual laboratories;
5. Development of the IT platform for virtually simulating the case studies prepared by companies;
6. Selection of the students;
7. Preparation of the case studies in all companies;
8. Establish a virtual laboratory in each university;
9. Running the pilot virtual internships;
10. Analysis of the results and feedbacks from students and companies;
11. Integration of the developed platform and methodology with the management systems in all partner universities.

### Results

- 214 UPT students in four study areas have been selected for project development (IT, computers and information technology, electronics and communications engineering and systems engineering)
- Tutors from 8 companies interested in selecting, recruiting and training students in skills necessary to the spirit at work have been trained within the project
- Creation of a laboratory for simulated enterprise in each partner university, that is used for assisting students to virtually do an internship in one of the partner companies
- Preparation of minimum 5 case studies in each of the 8 companies working with UPT
- Testing of the developed platform for training 212 students, on a virtual internship with the technological companies
- Development of a guide for working in a simulated enterprise.



## Applicability and transferability of the results

The developed framework can be transferred to any university looking for the implementation of virtual internships at various levels of the academic curricula.

Based on the pilot project, more technological companies can be involved in providing students with valuable skills, that might increase their employability, with the help of a software platform, thus not implying perturbation within the day to day work in the company.

Based on bilateral agreements, the universities will be able to offer valuable working experience for all their students, virtually, in the best technological companies.



## Fields of interest

Virtual internships, virtual mobilities, IT platforms for virtual training, employability skills for students, virtual laboratories and training, blended-learning, modern educational technologies, engineering teaching, curricula development, virtual campus.



Investiție în oameni!  
Proiect cofinanțat din Fondul Social European prin  
Programul Operațional Sectorial pentru Dezvoltarea Resurselor Umane 2007-2013



### Curios să vezi cum se lucrează într-o companie de succes?

Urmează cursurile întreprinderii simulate și vei lua parte la simulări virtuale ale proceselor de lucru dintr-o companie reală, cu asistența unor tutori specializați. În plus, ai șansa la un stagiu de practică într-o companie de succes.



## Research centre

Center for eLearning

## Financed through/by

European Social Fund, Development of Human Resources

## Research team

Diana Andone, Radu VasIU, Nicolae Robu, Mihai Onita, Delia Tanase, Andrei Ternauciu, Muguras Mocofan, Bogdan Dragulescu.



## Contact information

Diana ANDONE, PhD

Center for e-Learning

Address: Bd. Vasile Pârvan, No. 2, RO300223, Timisoara

Phone/Fax: (+40) 256 403 300

Email: [diana.andone@upt.ro](mailto:diana.andone@upt.ro)

Web: <http://elearning.upt.ro/>, [www.intreprindere-simulata.ro](http://www.intreprindere-simulata.ro)

## eSTART – MULTI-REGIONAL MASTER STUDY PROGRAMME IN THE FIELD OF eACTIVITIES

### Goal of the project

The project's goal is to create new learning opportunities, training and development at the master level, based on a multi-regional approach, by developing a program of study focused on the use of ICT technologies and collaborative environments in the organization, teaching and operation according to Bologna process.

The program will be piloted in the training of professionals in the use, implementation and development of e-services, e-work, e-applications and platforms and related technologies.

### Short description of the project

Specific objectives:

- acquisition at institutional level of the procedures and methodologies in the organization, implementation and promotion of master programs developed at multi-regional level, supported by new ICT solutions
- achieving an open structure of organization and operation of a Master program, student-centered, developed multi-regionally and allowing flexible access (time, location, curriculum)
- description in terms of skills of a relevant curriculum and implementation of e-activities program (with specialization e-Business, e-Health, e-Government&administration, e-Media)
- providing a program of study focused on an integrated platform using online education and training, based on blended-learning and support offered by ICT for intelligent monitoring and evaluation of educational activities to promote quality
- conduct a pilot program using the procedures, methodology, educational materials and technology implemented with the creation of a virtual community of e-activities.



### Project implemented by

Politehnica University of Timisoara  
Technical University of Cluj-Napoca  
"Transilvania" University of Brasov  
Babes-Bolyai University of Cluj-Napoca



### Main activities

Development of a framework for implementing multi-regional study programs, at Master level, which are making use of new ICT technologies and modern educational paradigms, such as blended-learning;

Implementing an educational platform for blended-learning, able to facilitate students and teachers co-operation in a multi-regional context;

Curriculum development for the proposed master program on e-Activities, with specializations in e-Business, e-Government, e-Media and e-Health;

Development of the study program, including course materials, practical application, interactive presentations, testing materials and other supporting educational resources;

Implementation and running of the pilot program and evaluation of the feedback from the participants;

Accreditation of the new training program.

### Implementation period

01.10.2010 – 30.09.2013

## Results

- Framework guide for the implementation of multi-regional study programs, which are making use of new ICT technologies and modern educational paradigms (blended-learning, online learning, e-tutoring)
- Introduction of 4 new occupational codes in the Romanian legislation: specialist in e-Business (COR 251301), specialist in e-Government (COR 251302), specialist in e-media (COR 251303) and specialist in e-Health (COR 251304)
- Development of 26 new blended-learning courses (6 coordinated by UPT)
- Publication of 6 course materials as books to an educational publisher
- Implementation and test of a platform, used for learning management and educational content management
- More than 200 students enrolled for the pilot program in e-Activities (50 from UPT)
- 22 UPT graduates of the full-program.

## Applicability and transferability of the results

The developed framework can be transferred to any Romanian university looking for the implementation of blended-learning programs at various levels.

The curricula and educational resources developed are used by the partner universities in running graduate programs and for post-university training, being nationally accredited. The curricula can be transferred nationally or internationally, based on educational agreements.

The developed model, based on open educational resources (OER) can be used by Romanian universities for developing their first MOOCs (Massive Open Online Courses).



## Fields of interest

Blended-learning, online learning, instructional design, modern educational technologies, engineering teaching, curricula development, virtual campus, OER - Open Educational Resources, MOOCs – Massive Open Online Courses.



## Research centre

Center for eLearning

## Financed through/by

European Social Fund, Development of Human Resources

## Research team

Radu VasIU, Diana Andone, Florin Alexa, Marian Bucos, Mihai Onita, Muguras Mocofan, Andrei Ternauciu, Silviu Vert, Vlad Mihaescu, Bogdan Dragulescu, Iasmina Ermalai, Aurel Gontean, Lacramioara Stoicu-Tivadar, Vasile Stoicu-Tivadar, Sorin Nanu, Marius Otesteanu, Inocentiu Maniu, Nicolae Robu, Vasile Gui, Dan Lascu, Vladimir Cretu, Delia Tanase, Dan Pescaru, Gheorghe Popa, Viorel Serban.

## Contact information

Prof. Radu VASIU, PhD  
Multimedia Research Centre  
Address: Bd. Vasile Pârvan, No. 2, RO300223, Timișoara  
Phone/Fax: (+40) 256 403 300  
Email: radu.vasiu@upt.ro  
Web: www.cm.upt.ro, http://cominpro.cm.upt.ro



## DIDATEC – LIFELONG LEARNING AND TRAINING FOR HIGHER EDUCATION TEACHERS IN THE TECHNICAL SCIENCES AND ENGINEERING FIELDS

### Goal of the project

DidaTec, a word that associates the “didactic” process with “technology”, started as an initiative of the main technical universities in Romania for the effective implementation of modern educational instruments and blended-learning technologies in the teaching-learning activity.

The project’s goal is to create the framework for the adaptation of the current higher education environment in the field of engineering to a world and a way of living that follows the digital revolution.

### Short description of the project

The general objective of the project is the improvement of education and training processes in the technical higher education (engineering sciences) through a complete and unitary program (national approach) of lifelong learning and training for higher education teachers. The project’s aim is the acquiring of competencies in interactive techniques of teaching & learning and IT&C, as a key factor for a relevant education in accordance with the specific needs of the economy.

The vision in mind is that of a true, active and engaging experience for the university student, based on her/his gadget-filled life in which science and engineering blend in, having the teacher as a companion.

The project will influence directly over 1,000 beneficiaries performing in technical universities in Romania during the implementation period, and an indirect estimate of over 20,000 students in the following 3 years.



### Project implemented by

Politehnica University of Timisoara  
Technical University of Cluj-Napoca  
“Transilvania” University of Brasov

### Implementation period

01.09.2010 – 31.12.2013

### Main activities

Implementing a pilot program, consisting of 6 courses on modern educational instruments and the use of IT&C for over 800 existing higher education teachers;

Implementing a mentorship program for over 200 young specialists/professionals starting a career in the field of engineering education;

Offering assistance and technical guidance for restructuring over 900 courses taught in universities throughout Romania in the field of engineering education;

Elaboration of a “Standard of quality for the program of lifelong learning and training for higher education teachers & trainers” and of a “Personal development plan” & “Career plan” - guidelines for the higher education teachers;

Teachers’ training and assistance for successfully use the modern teaching & learning techniques, based on IT&C support.

### Results

- Elaboration of the Standard of quality for the program of blended-learning and training for higher education teachers
- Elaboration of a guide for Personal development plan and Career plan for the juniors in academic career
- Development of the DidaTec training course – the only Romanian training program in blended-learning, modern educational technologies and use of ICT in education, dedicated to higher education in engineering fields
- Running of the DidaTec program for over 784 teachers in 12 Romanian universities (126 from UPT)
- Development of the Mentoring program – designed for
- Training of 10 mentors in UPT, followed by running the mentoring program for 38 juniors
- Development of 166 new courses, based on blended-learning technologies, integrated on the UPT Virtual Campus

## Applicability and transferability of the results

The project developed a training program, accredited at national level, that provides training in the use of ICT and modern technologies in higher education. This program is an ARACIS prerequisite for academic staff that want to teach in distance learning programs, helping them to improve their teaching quality in the digital age. Initially developed for teaching engineering and technical sciences, the methodology, as well as the DidaTec training program, can be easily transferred to other fields of academic teaching. The mentoring program can be directly applied for any junior academic staff.



## Fields of interest

Blended-learning, online learning, instructional design, modern educational technologies, engineering teaching, academic career planning, mentoring system, virtual campus.



## Research centre

Center for eLearning

## Financed through/by

European Social Fund, Development of Human Resources



## Research team

Radu Vasiu, Diana Andone, Muguras Mocofan, Carmen Holotescu, Mugur Dragomir, Marian Bucos, Andrei Ternauciu, Mihai Onita, Silviu Vert, Vlad Mihaescu, Bogdan Dragulescu, Iasmina Ermalai, Carmen Alic, Daniel Grecea, Vasile Stoicu-Tivadar, Nicolae Muntean, Dan Stoiciu, Teodor Todinca, Liviu Marsavina, Vladimir Cretu, Sabin Ionel, Carmen Grecea, Viorel Serban, Toma Dragomir, Florin Alexa, Dan Lascu.

## Contact information

Prof. Radu VASIU, PhD  
Multimedia Research Centre  
Address: Bd. Vasile Pârvan, No. 2, RO300223, Timisoara  
Phone/Fax: (+40) 256 403 300  
Email: radu.vasiu@upt.ro  
Web: www.cm.upt.ro, <http://cominpro.cm.upt.ro>

## TRANSNATIONAL EDUCATIONAL NETWORK FOR CAREER GUIDANCE, COUNSELING AND PRACTICE CORRELATED WITH THE LABOUR MARKET, IN THE SOCIETY OF KNOWLEDGE – PRACTICOR

### Goal of the project

The general objective of the project is the organization of the students' practice in order to offer them increased chances, consolidated by training, in accordance with reality, as well as guidance and counseling to those who wish to have successful careers in foreground fields of engineering and to improve their skills by practice, correlating the educational process with the labour market.

The specific objectives are:

- to achieve durable partnerships with the employers for the practice of the students from the "Politehnica" University of Timisoara (Faculty of Mechanics) and the University of Pitesti respectively and to establish a good relationship with the business community, which we hope to be a long-lasting one;
- to form a network of tutors (coming from industrial, commercial, production and research units) to coordinate and guide the students' practice, in accordance with the concrete needs of the society and the present stage of the knowledge of firms and scientific and technical evolution in general;
- to develop a career guideline and counseling system integrated in the students' practice as well as in their professional and academic education in general;
- to train and develop the necessary students' competencies for their future job and in order to ensure their future, including the formation of professional opening abilities;
- to promote and disseminate the results and examples of good practice developed within the project;
- to generate the material resources to enlarge the experience for the continuity and generalization of the project idea after its finalization.

### Project implemented by

Politehnica University Timisoara, with University of Pitesti, Institute for Studies and Power Engineering and Fraunhofer - Gesellschaft zur Förderung der angewandten Forschung from Germany.

### Implementation period

01.08.2010 - 30.07.2013

### Main activities

- Preparatory activity of the student practice;
- Counseling and orientation in career;
- Practical activity of students;
- Management activity;
- Information and publicity activity;

### Short description of the project

The project proposes an innovative model (vision) of practice for the students from technical universities (UPT and UPit), in order to increase performance and quality. The revival of the notion of applicative practice, directly linked to economic units, will complement the information with which the student, after becoming a graduate, finalizes his/her studies. It also contributes to the enlargement of the selection basis of the candidates to academic education, following the activity of professional counseling of high school pupils, in correlation with the development needs of the economy.



The project also contributes to the formation of tutors coming from the economic-industrial environment (partner firms for practice) who should form the link between education and economic units, in the context of the actual requirements, thus increasing the sustainability of the operational objectives of the project. The project is the instrument by means of which students are guided and counseled to continue their studies in the field of engineering, and the students are counseled and financed so they can choose the best suited direction of specialization in order to obtain a B. Sc. degree and a M. Sc. degree, doubling their theoretical knowledge by practice and activities related to aspects of technological avant-garde and useful applications for society on the whole, through direct contact with (private and state) companies which thus become practice partners within the project.

## Results

- Students supported in the transition from school to work;
- Pupils matriculated in the national educational system;
- Beneficiaries career counseling services;
- Partnerships concluded for exchange of experience and best practices;
- Transnational partners involved in the project;
- Specialized staff with tutorial attributions, from the companies that organize practice stages (practice partners) trained in project on base of CNFPA accredited courses, etc.



## Fields of interest

Are part of the strategy of the European Council re launched the Lisbon strategy by switching emphasis on economic development and employment growth in the spirit of the Community Strategic Guidelines on Cohesion. Following options are focused:

- strengthening and stimulating student motivation involved in a program of counseling and professional orientation;
- development of an effective program for accounting students in framing their practice;
- proper dissemination of information among students for internships; the development of support materials for counseling and internship;
- creating of students' skills on techniques for searching a suitable job training acquired
- Entrepreneurial skills development;
- Offering models for the young generation, as basic scope and future scope of achievements.

## Financed through/by

European Social Fund through the Human Resources Development Operational Programme 2007 - 2013.

## Research team

Prof. Dr. Eng. Ioana IONEL  
 Prof. Dr. Eng. Dumitru TUCU  
 Prof. Dr. Eng. Ilare BORDEASU  
 Assoc. Dr. Eng. Mircea VASILESCU  
 Assoc. Dr. Eng. Georgeta-Emilia MOCUTA  
 Lect. Dr. Eng. Luisa Izabel DUNGAN  
 Ec. Iris MIHAI  
 Lect. Dr. Eng. Liliana TULCAN  
 Lect. Dr. Eng. Raul Ciprian IONEL  
 Lect. Dr. Eng. Adelina HAN  
 Lect. Dr. Eng. Adrian STUPARU  
 Lect. Dr. Eng. Ioan GROZA  
 Lect. Dr. Eng. Werner STEFANESCU  
 Dr. Eng. Dumitru CEBRUCEAN  
 Dr. Eng. Ion VETRES  
 Dana HUDAC  
 Alina ATANASESCU  
 Mihaela TILINCA etc.



## Contact information

Prof. Ioana IONEL, PhD  
 Department of Mechanical Machines, Equipment and Transportation  
 Address: Bd. Mihai Viteazu, No. 1, RO300222, Timisoara  
 Phone/Fax: (+40) 256 403 670  
 Mobile: (+40) 723 349 337  
 E-mail: ioana.ionel@upt.ro  
 www.practicor.ro



## NATIONAL NETWORK OF TRAINING FOR TEACHERS FROM PROFESSIONAL AND TECHNICAL PRE-UNIVERSITY EDUCATION – CONCORD

### Goal of the project

The main objective of the project is development of skills of teachers from professional and technical pre-university education within a complex system of “blended learning”, which includes:

- Class study, assisted by trainers;
- Individual study;
- On-line study, in an interactive learning environment.

### Short description of the project

this project supports the improvement process of the national system of education and training, human resource generator performance, competitive, creative, involved in the development of the knowledge society, from the perspective of lifelong learning.

Benefits of teachers from professional and technical pre-university education are:

- An effective learning environment possible for students to select the best activities to suit their own pace and most effective learning style, ability to investigate, explore and solve problems they encounter in learning.



- The possibility of students to “be together and apart” by the existence of the virtual community of learners who can interact anytime and anywhere, via computer-mediated educational tools.

- Opportunity to expand business dimension in school education and involvement in production or research projects. They will form a solid basis for developing creative and original modern teaching methods, E-learning Distance has to give content and personal career value in a knowledge-based society.

- Increasing competitiveness of teachers, beneficiaries of training programs proposed by the project, ensured by monitoring achievement of predefined quality standards.

The project proposes at developing human capital and lifelong learning by linking the labour market for at least 600 teachers.

### Project implemented by

Politehnica University of Timisoara, in partnership with University Politehnica of Bucharest (project coordinator), Tehnical University “Gheorghe Asachi” of Iasi, Tehnical University of Cluj-Napoca, National Centre for the Development of Professional and Technical Education and MultiMedia Sunshine Ltd. from England.



### Main activities

- Realization of a study to establish the content of teacher training university in accordance with the identified needs of the labor market and society based on knowledge, but also their interest & pre-technical education institutions;
- Promote the importance of continuous training provided by this project for teacher education;
- Developing curricula for teacher training;
- Development of 11 training programs for teachers from professional and technical pre-university education;
- Accreditation of four centers of continuous training;
- Providing of the 11 training programs.

### Financed through/by

European Social Fund through the Human Resources Development Operational Programme 2007 - 2013

### Implementation period

01.11.2010 – 30.10.2013

## Results

- Increasing the attractiveness and quality of educational programs and professional training offered by teachers from professional and technical pre-university education.
- Skills gained will enable teachers conduct modern, professional and effective thus ensuring increased quality of teaching, learning and assessment.

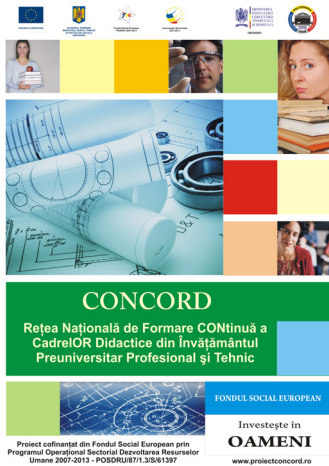

## Fields of interest

CONCORD project's overall objective consists of developing professional skills and technical up dated vocational and technical education, within a complex system of "blended learning", which includes: study on line and face to face, assisted by trainers; individual home works completed by on-line learning in an interactive environment (e-learning MOODLE platform). The EU needs creativity and competitiveness and this is based especially on innovative science education. Thus the teachers were formed more versus applicability of knowledge, in technology, engineering, mathematic, physics, environmental issues, chemistry, etc. and they also must be trained for being able to raise the attractiveness of science education and scientific carriers and boost the interest of young people to support technically the development of a democratic, knowledge-based society. The project developed 11 professional training programs, including two types of programs in accordance to the Minister Order No. 4611/2005, with a maximum of 340 hours and 105 credit points (certified by national attested body):

- (i) Environmental training program (Management and Communication and Information and Communication Techniques), and
- (ii) Thematic programs of type long way, on 4 domains and 11 sub domains, consisting of:
  - a.2 subjects from basic training
  - b.2 subjects of specialized training

## Research team

Prof. Dr. Eng. Ioana IONEL  
Prof. Dr. Eng. Sabin IONEL  
Prof. Dr. Eng. Radu VASIU  
Prof. Dr. Eng. Mircea POPA  
Lect. Dr. Eng. Marian BUCOS  
Lect. Dr. Eng. Luisa Izabel DUNGAN  
Dr. Eng. Ramon Balogh  
Dr. Eng. Diana ANDONE  
PhD. Viorica CEBRUCEAN  
Simona FILIPAS  
Iris MIHAI

## Applicability and transferability of the results:

The support of a good education starts from kindergarten, but the skills of teachers, especially these from undergraduate schools must be developed and supported, especially of those that are involved in technical domains, knowing the fact that they must generate the interest of pupils versus engineering carriers.



## Research centre

Research Centre for Thermal Machines and Equipments, Transportation and Environmental Pollution Control

## Contact information

Prof. Ioana IONEL, PhD  
Department of Mechanical Machines, Equipment and Transportation  
Address: Bd. Mihai Viteazu, No. 1, RO300222, Timisoara  
Phone/Fax: (+40) 256 403 670  
Mobile: (+40) 723 349 337  
E-mail: ioana.ionel@upt.ro  
www.proiectconcord.ro

## ASIGMA - QUALITY ASSURANCE IN INTERNATIONALIZED MASTER EDUCATION

### Goal of the project

- Improvement of university management and increase of the capacity of higher education institutions to provide internationalized master programs adapted to global market requirements
- Improvement of national internationalized master programs
- Development and implementation of internal assessment instruments for institutions that provide internationalized master programs
- Development and implementation of a quality assurance framework for the internationalized master education

### Short description of the project

The management staff with responsibilities in higher education, particularly in the development of internationalized master programs benefit of opportunities for improvement of management and educational competencies through exchanges of good practices.

The teaching staff and students involved in internationalized master programs are provided with an improved, innovative educational framework centered on learning outcomes and on involvement of all stakeholders into the educational process for development of competencies required by the labour market.

The personnel involved in institutional quality assurance are provided with instruments fit for performing relevant evaluations. These instruments contribute to increase the awareness of internationalized education paradigm for all actors involved in master education.

A quality reference framework for elaboration, upgrading and consolidation of quality assurance policies for higher education at legal and institutional level is provided.

### Project implemented by

- Babes-Bolyai University, Cluj-Napoca
- Transilvania University, Brasov
- Dunarea de Jos University, Galati
- ASE, Bucharest
- Politehnica University Timisoara
- Alexandru Ioan Cuza University, Iasi
- WUT, Timisoara
- Ovidius University, Constanta
- ARACIS, Bucharest

### Implementation period

2010-2013

### Main activities

- A1. Development of a partnership network
- A2. Exchange of good practices
- A3. Elaboration of a study concerning the internationalized master program in a European context
- A4. Development of internal evaluation instruments for internationalized master programs
- A5. Organization of the "Internationalized Education Day"
- A6. Improvement of internationalized master curricula
- A7. Development of quality assurance methodology for internationalized masters
- A8. Development of an information system for quality management and assurance in internationalized master programs
- A9. Transfer of the quality assurance methodology for internationalized master programs to the national external evaluation and accreditation methodology
- A10. Consolidation of the partnership network



## Results

- Report concerning a qualitative study of Romanian internationalized master programs in the European context
- 4 instruments of internal quality assessment according to work-teams profiles: master directors / coordinators involved in management and curricula development, professors, linguistic specialist and students
- 24 master programs evaluated and improved in what concerns infrastructure, equipment and education: curriculum development, teaching materials, cooperation, correlation of competencies with labour market requirements
- Quality assurance methodology for the internationalized master education
- 1 document – recommendation for improvement of national quality assurance methodology
- 1 partnership network
- 6 conferences
- 6 seminars
- 9 “Internationalized Education Day” type events

## Applicability and transferability of the results

The following entities are supposed to use the results of the project:

- National educational institutions that run internationalized master programs
- National agency for quality assurance in higher education
- Local, institutional boards for quality assurance in higher education
- Managers / directors / coordinators of internationalized master programs
- Higher education institutions for conception of a coherent internationalization policy
- Entities involved in evaluation, assessment and ranking of higher education institutions that use internationalization as a ranking criterion

## Fields of interest

- Quality assurance
- Higher education management
- Internationalization of higher education
- European Higher Education Area
- Conception of internationalized master programs



## Financed through/by

Ministry of Labour, Family and Equal Opportunities  
Sectorial Operational Programme  
Human Resources Development  
2007-2013

## Research centre

Center for eLearning

## Research team

Prof. Dr. Eng. Dan Stoiciu  
Prof. Dr. Georgeta Ciobanu  
Prof. Dr. Eng. Alexandru Isar  
Prof. Dr. Eng. Aldo De Sabata  
Lecturer Dr. Eng. Robert Pazsitka  
Student Eng. Calin Crisan  
Student Eng. Florentina Trif  
Financial officer Cristina Bunea  
Responsible for payroll Nicolina Adamescu

## Contact information

Prof. Dan STOICIU, PhD  
Department of Measurements and Optical Electronics  
Address: Bd. Vasile. Pârvan, No. 2, RO300223, Timisoara  
Phone: (+40) 256 403 360  
Fax: (+40) 256 403 362  
E-mail: dan.stoiciu@upt.ro



## FLEXFORM-PROFESSIONAL TRAINING PROGRAMME USING MECHATRONIC PLATFORMS

### Goal of the project

The main goal of the project consists in the elaboration and implementation of a flexible training programme using mechatronic platforms destined to upper secondary school teachers, to develop competency in applying modern educational technologies and to increase efficiency within the teaching & learning process.

### Short description of the project

Seven new regional centres in education and flexible professional training were established, using the existing structures of the departments of mechatronics, including the centre in Timisoara (for the counties Timis, Arad, Hunedoara and Caras-Severin). These are nationally accredited structures being in charge with the implementation of the training programme over the associated regions.

The network running mode offers a systemic approach that integrates training activities and guarantees an improvement of the programme management. A Virtual Centre for Competencies in Mechatronics was created; it includes libraries, knowledge-base, virtual labs, training packages. FLEXFORM Programme comprises three modules of continuous education, accredited by National Education Ministry, summarizing 65 credit points.



### Main activities

FLEXFORM offers the following modules of hybrid courses:

1st module: Informatics and educational technologies (25 cp)

- C1: Applied informatics in education and training (38 h);

- C2: Interactive environments and educational technologies (38 h).

2nd module: Mechatronics I. Mechatronic platforms for education and flexible training (25 cp):

- C3: Technology and education in mechatronics. Sustainable development (38 h);

- C4: Methods and techniques of innovation and creativity (38 h).

3rd module: Mechatronics II. Technological development and educational technologies within the knowledge-based society (15 cp):

- C5: Technological development and educational technologies (38 h).

Evaluation is sustained at the end of the training program, by a public presentation of a thesis for each module.

### Project implemented by

Department of Mechatronics in UPT, Project n. POSDRU/87/1.3/S/64069

### Implementation period

01.Sept.2010-16.Jan.2014

### Research centre

Center for eLearning

## Results

186 graduates from all the counties covered by the regional centre Timis, lectures and labs created by the team of experts, uploaded on the virtual centre platform.

## Applicability and transferability of the results

Professional training in mechatronics for any teacher in secondary schools of Romania and for any trainer in mechatronics.

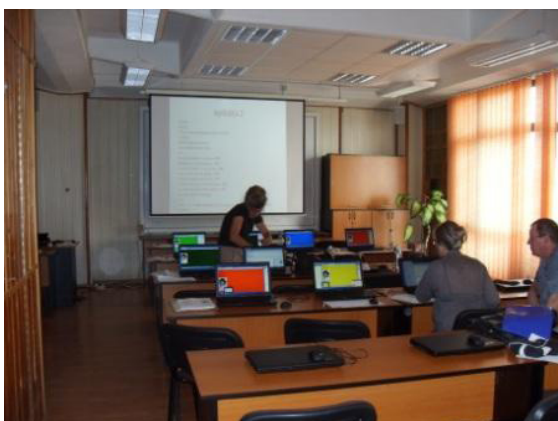

## Fields of interest

Education and training in mechatronics, educational technologies.

## Research team

Regional managerial component (Valer DOLGA, Lia DOLGA, Daniela HUDAC, Dorina RUSSET ), short term experts as course lecturers (Arjana DAVIDESCU, Andreea DOBRA, Adriana T EODORESCU, George SAVII, Iosif CARABAS, Valentin CIUPE, Cristian MOLDOVAN) and an administrator (Ioan CRASTIU).



## Financed through/by

Government of Romania, European Structural Fund POSDRU 2007-2013.

## Contact information

Prof. Valer DOLGA, PhD  
Department of Mechatronics  
Address: Bd. Mihai Viteazu, No.1, RO300222, Timisoara  
Phone: (+40) 256 403 554.  
E-mail: valer.dolga@upt.ro



## Projects supported by private funds



UPT considers that scientific research is a priority of the university mission, conferring personality and distinction to the university, and that reaching excellence in scientific research is a target on medium and long term.

A series of inter-institutional collaborations have crucially influenced UPT's ranking in the 2011 classification exercise. Two main categories of institutional collaborations are to be noted: inter-university collaborations and collaborations with enterprises. Each of them has clearly established, mutually-shared objectives: mutual support, know-how transfer, and cooperation objectives for a common output.

UPT has always maintained a close relationship with the community, with the external environment, this relationship being its own reason to exist. Beyond the actual research and formal education, the research accomplished through technological transfer has been a constant concern for the University departments, faculties and management structures, which is reflected in the number of contracts with private companies.

This chapter presents the research contracts with third parties.

Field	Total number of projects
Power Engineering	6
Mechanical Engineering	1
Electrical Engineering	1
Civil Engineering	2
Chemical Engineering	1



## PHOTOVOLTAIC SOURCES INTEGRATION IN THE ROMANIAN POWER SYSTEM. CASE STUDY FOR TIMISOARA AREA

### Goal of the project

Power system analysis and optimization for the photovoltaic sources integration in the Timisoara area of the Romanian Power System (Enel Banat Distribution Operator).

### Short description of the project

The renewable energy sources represent an important issue for the Romanian and EU energy policy and sustainable development strategy. The projects refer to photovoltaic sources integration in the Timisoara area of the Romanian Power System (Enel Banat Distribution Operator). The analysis has been performed for the North-Western, Western, Central and South-Western part of the System. Various operating condition, with the consumption forecast for 2013, 2018 and 2023, were considered, taking into account all the renewable energy sources (wind, solar, biomass, hydro). The medium voltage network for the interest area was modelled in detail.

### Project implemented by

- Alpas Fotovoltaico, Zona Studio, Solento Impianti Timisoara

### Implementation period

2013-2014

### Main activities

- power system data base validation;
- Enel Banat distribution network modeling and operating condition analysis;
- power consumption and renewable energy generation forecast;
- power flow computing for various operating condition of the North-Western, Western, Central and South-Western part of the Romanian Power System (peak and minimum type regimes, 2013, 2018, 2023);
- contingency analysis, in the presence / absence of the renewable energy sources.



### Results

- power flow corresponding to 2013 year and forecasted 2018 and 2023 years;
- power flow corresponding to the medium voltage electrical network (Enel Banat Timisoara area);
- voltage value without / with the new producers;
- quick / slow maximum voltage variation value for critical buses;
- transformer loading without / with the new producers;
- power flow through the power system elements and loading level;
- integration solution validation and system reinforcement recommendations (if necessary).

### Applicability and transferability of the results

Knowledge transfer to other photovoltaic power plants developers and designers. Electrical distribution network operator (Enel, CEZ, EON, Electrica in Romania).

### Fields of interest

- photovoltaic energy sources;
- other renewable energy sources;
- renewable sources' integration in the power systems;
- distribution network operators.

### Research Centre

Research Centre for Power Systems Analysis and Optimization

### Financed through/by

Alpas Fotovoltaico, Zona Studio, Solento Impianti Timisoara, total value: 26.500 RON (5.900 Euro)

### Research team

Stefan KILYENI, Constantin BARBULESCU, Attila SIMO, Annamaria KILYENI

### Contact information

Prof. Dr. Eng. Ștefan KILYENI/ Ș. L. Dr. Eng. Constantin BARBULESCU  
Department of Power Engineering  
Address: Bd. Vasile Pârvan, No. 2, RO300223, Timisoara  
Phone: (+40) 256 403 430/ (+40) 256 403 416  
E-mail: stefan.kilyeni@upt.ro/ constantin.barbulescu@upt.ro

## PHOTOVOLTAIC SOURCES INTEGRATION IN THE ROMANIAN POWER SYSTEM. CASE STUDY FOR SANNICOLAU MARE - JIMBOLIA AREA

### Goal of the project

Power system analysis and optimization for the photovoltaic sources integration in the Sannicolau Mare – Jimbolia area of the Romanian Power System (Enel Banat Distribution Operator).

### Short description of the project

The renewable energy sources represent an important issue for the Romanian and EU energy policy and sustainable development strategy. The projects refer to photovoltaic sources integration in the Sannicolau Mare – Jimbolia area of the Romanian Power System (Enel Banat Distribution Operator). The analysis has been performed for the North-Western, Western, Central and South-Western part of the System. Various operating condition, with the consumption forecast for 2013, 2018 and 2023, were considered, taking into account all the renewable energy sources (wind, solar, biomass, hydro). The medium voltage network for the interest area was modelled in detail.

### Project implemented by

- Cons Electrificarea Instal, Trinovolt, Duepi, Elleaerre Timisoara

### Implementation period

2013-2014

### Main activities

- power system data base validation;
- Enel Banat distribution network modeling and operating condition analysis;
- power consumption and renewable energy generation forecast;
- power flow computing for various operating condition of the North-Western, Western, Central and South-Western part of the Romanian Power System (peak and minimum type regimes, 2013, 2018, 2023);
- contingency analysis, in the presence / absence of the renewable energy sources.



### Results

- power flow corresponding to 2013 year and forecasted 2018 and 2023 years;
- power flow corresponding to the medium voltage electrical network (Enel Banat Timisoara area);
- voltage value without / with the new producers;
- quick / slow maximum voltage variation value for critical buses;
- transformer loading without / with the new producers;
- power flow through the power system elements and loading level;
- integration solution validation and system reinforcement recommendations (if necessary).

### Applicability and transferability of the results

Knowledge transfer to other photovoltaic power plants developers and designers. Electrical distribution network operator (Enel, CEZ, EON, Electrica in Romania).

### Fields of interest

- photovoltaic energy sources;
- other renewable energy sources;
- renewable sources' integration in the power systems;
- distribution network operators.

### Research Centre

Research Centre for Power Systems Analysis and Optimization

### Financed through/by

Cons Electrificarea Instal, Trinovolt, Duepi, Elleaerre Timisoara, total value: 46.000 RON

### Research team

Stefan KILYENI, Constantin BARBULESCU, Attila SIMO, Annamaria KILYENI

### Contact information

Prof. Dr. Eng. Ștefan KILYENI/ Ș. L. Dr. Eng. Constantin BARBULESCU  
Department of Power Engineering  
Address: Bd. Vasile Pârvan, No. 2, RO300223, Timisoara  
Phone: (+40) 256 403 430/ (+40) 256 403 416  
E-mail: stefan.kilyeni@upt.ro/ constantin.barbulescu@upt.ro



## PHOTOVOLTAIC SOURCES INTEGRATION IN THE ROMANIAN POWER SYSTEM. CASE STUDY FOR LUGOJ - FAGET AREA

### Goal of the project

Power system analysis and optimization for the photovoltaic sources integration in the Lugoj – Faget area of the Romanian Power System (Enel Banat Distribution Operator).

### Short description of the project

The renewable energy sources represent an important issue for the Romanian and EU energy policy and sustainable development strategy. The projects refer to photovoltaic sources integration in the Lugoj – Faget area of the Romanian Power System (Enel Banat Distribution Operator). The analysis has been performed for the North-Western, Western, Central and South-Western part of the System. Various operating condition, with the consumption forecast for 2013, 2018 and 2023, were considered, taking into account all the renewable energy sources (wind, solar, biomass, hydro). The medium voltage network for the interest area was modelled in detail.

### Project implemented by

- Instal 5F Construct, Green Paints Timisoara, Bethausen City Hall

### Implementation period

2013-2014

### Main activities

- power system data base validation;
- Enel Banat distribution network modeling and operating condition analysis;
- power consumption and renewable energy generation forecast;
- power flow computing for various operating condition of the North-Western, Western, Central and South-Western part of the Romanian Power System (peak and minimum type regimes, 2013, 2018, 2023);
- contingency analysis, in the presence / absence of the renewable energy sources.



### Results

- power flow corresponding to 2013 year and forecasted 2018 and 2023 years;
- power flow corresponding to the medium voltage electrical network (Enel Banat Timisoara area);
- voltage value without / with the new producers;
- quick / slow maximum voltage variation value for critical buses;
- transformer loading without / with the new producers;
- power flow through the power system elements and loading level;
- integration solution validation and system reinforcement recommendations (if necessary).

### Applicability and transferability of the results

Knowledge transfer to other photovoltaic power plants developers and designers. Electrical distribution network operator (Enel, CEZ, EON, Electrica in Romania).

### Fields of interest

- photovoltaic energy sources;
- other renewable energy sources;
- renewable sources' integration in the power systems;
- distribution network operators.

### Research Centre

Research Centre for Power Systems Analysis and Optimization

### Financed through/by

Instal 5F Construct, Green Paints Timisoara, Bethausen City Hall, total value: 32.300 RON

### Research team

Stefan KILYENI, Constantin BARBULESCU, Attila SIMO, Annamaria KILYENI

### Contact information

Prof. Dr. Eng. Ștefan KILYENI/ Ș. L. Dr. Eng. Constantin BARBULESCU  
Department of Power Engineering  
Address: Bd. Vasile Pârvan, No. 2, RO300223, Timisoara  
Phone: (+40) 256 403 430/ (+40) 256 403 416  
E-mail: stefan.kilyeni@upt.ro/ constantin.barbulescu@upt.ro

## PHOTOVOLTAIC SOURCES INTEGRATION IN THE ROMANIAN POWER SYSTEM. CASE STUDY FOR CARAS-SEVERIN AREA

### Goal of the project

Power system analysis and optimization for the photovoltaic sources integration in the Caras-Severin area of the Romanian Power System (Enel Banat Distribution Operator).

### Short description of the project

The renewable energy sources represent an important issue for the Romanian and EU energy policy and sustainable development strategy. The projects refer to photovoltaic sources integration in the Caras-Severin area of the Romanian Power System (Enel Banat Distribution Operator). The analysis has been performed for the North-Western, Western, Central and South-Western part of the System. Various operating condition, with the consumption forecast for 2013, 2018 and 2023, were considered, taking into account all the renewable energy sources (wind, solar, biomass, hydro). The medium voltage network for the interest area was modelled in detail.

### Project implemented by

- Solaris Gugulania Caransebes, Mino Energy Timisoara

### Implementation period

2013-2014

### Main activities

- power system data base validation;
- Enel Banat distribution network modeling and operating condition analysis;
- power consumption and renewable energy generation forecast;
- power flow computing for various operating condition of the North-Western, Western, Central and South-Western part of the Romanian Power System (peak and minimum type regimes, 2013, 2018, 2023);
- contingency analysis, in the presence / absence of the renewable energy sources.



### Results

- power flow corresponding to 2013 year and forecasted 2018 and 2023 years;
- power flow corresponding to the medium voltage electrical network (Enel Banat Timisoara area);
- voltage value without / with the new producers;
- quick / slow maximum voltage variation value for critical buses;
- transformer loading without / with the new producers;
- power flow through the power system elements and loading level;
- integration solution validation and system reinforcement recommendations (if necessary).

### Applicability and transferability of the results

Knowledge transfer to other photovoltaic power plants developers and designers. Electrical distribution network operator (Enel, CEZ, EON, Electrica in Romania).

### Fields of interest

- photovoltaic energy sources;
- other renewable energy sources;
- renewable sources' integration in the power systems;
- distribution network operators.

### Research Centre

Research Centre for Power Systems Analysis and Optimization

### Financed through/by

Solaris Gugulania Caransebes, Mino Energy Timisoara, total value: 23.200 RON

### Research team

Stefan KILYENI, Constantin BARBULESCU, Attila SIMO, Annamaria KILYENI

### Contact information

Prof. Dr. Eng. Ștefan KILYENI/ Ș. L. Dr. Eng. Constantin BARBULESCU  
Department of Power Engineering  
Address: Bd. Vasile Pârvan, No. 2, RO300223, Timisoara  
Phone: (+40) 256 403 430/ (+40) 256 403 416  
E-mail: stefan.kilyeni@upt.ro/ constantin.barbulescu@upt.ro

## PHOTOVOLTAIC SOURCES INTEGRATION IN THE ROMANIAN POWER SYSTEM. CASE STUDY FOR ARAD AREA

### Goal of the project

Power system analysis and optimization for the photovoltaic sources integration in the Arad area of the Romanian Power System (Enel Banat Distribution Operator).

### Short description of the project

The renewable energy sources represent an important issue for the Romanian and EU energy policy and sustainable development strategy. The projects refer to photovoltaic sources integration in the Arad area of the Romanian Power System (Enel Banat Distribution Operator). The analysis has been performed for the North-Western, Western, Central and South-Western part of the System. Various operating condition, with the consumption forecast for 2013, 2018 and 2023, were considered, taking into account all the renewable energy sources (wind, solar, biomass, hydro). The medium voltage network for the interest area was modelled in detail.

### Project implemented by

- Milanodue Green Energy Arad, Energy Tipari Timisoara, Ambra Service Arad

### Implementation period

2013–2014

### Main activities

- power system data base validation;
- Enel Banat distribution network modeling and operating condition analysis;
- power consumption and renewable energy generation forecast;
- power flow computing for various operating condition of the North-Western, Western, Central and South-Western part of the Romanian Power System (peak and minimum type regimes, 2013, 2018, 2023);
- contingency analysis, in the presence / absence of the renewable energy sources.



### Results

- power flow corresponding to 2013 year and forecasted 2018 and 2023 years;
- power flow corresponding to the medium voltage electrical network (Enel Banat Timisoara area);
- voltage value without / with the new producers;
- quick / slow maximum voltage variation value for critical buses;
- transformer loading without / with the new producers;
- power flow through the power system elements and loading level;
- integration solution validation and system reinforcement recommendations (if necessary).

### Applicability and transferability of the results

Knowledge transfer to other photovoltaic power plants developers and designers. Electrical distribution network operator (Enel, CEZ, EON, Electrica in Romania).

### Fields of interest

- photovoltaic energy sources;
- other renewable energy sources;
- renewable sources' integration in the power systems;
- distribution network operators.

### Research Centre

Research Centre for Power Systems Analysis and Optimization

### Financed through/by

Milanodue Green Energy Arad, Energy Tipari Timisoara, Ambra Service Arad, total value: 26.600 RON

### Research team

Stefan KILYENI, Constantin BARBULESCU, Attila SIMO, Annamaria KILYENI

### Contact information

Prof. Dr. Eng. Ștefan KILYENI/ Ș. L. Dr. Eng. Constantin BARBULESCU  
Department of Power Engineering  
Address: Bd. Vasile Pârvan, No. 2, RO300223, Timisoara  
Phone: (+40) 256 403 430/ (+40) 256 403 416  
E-mail: stefan.kilyeni@upt.ro/ constantin.barbulescu@upt.ro

## MUNTENIA NORD ELECTRICAL DISTRIBUTION NETWORK ANALYSIS AND OPTIMIZATION

### Goal of the project

Distribution network real technical losses evaluation for Electrica Muntenia Nord Distribution System Operator. Power flow computing for various operating condition of the Central, South and South-Eastern part of the Romanian Power System (peak and minimum type regimes).

### Short description of the project

The study was conducted for Electrica Muntenia Nord Distribution System Operator. An algorithm is proposed by the authors being able to compute the load dependent and non-dependent technical losses. The analysis has been performed for the Central, South and South-Eastern part of the Romanian Power System. Quantitative and qualitative on-field measurements are provided and discussed, followed by the technical losses computing based on the provided algorithm. Different necessary scenarios for the distribution network operator have been taken into consideration highlighting the optimal operating conditions.

### Project implemented by

- Servelect Cluj-Napoca, Electrica Muntenia Nord

### Implementation period

January - June 2013

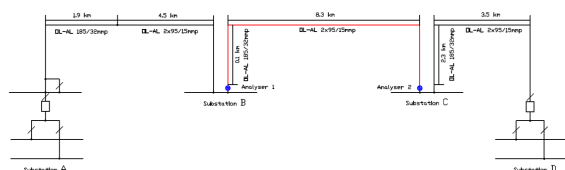

### Main activities

- on-field power flow monitoring in case of several overhead lines;
- algorithm development for technical losses evaluation;
- electrical distribution network modelling;
- optimal power flow considering different scenarios;
- comparison and analysis based on the these approaches.

### Results

- algorithm used for technical losses evaluation;
- electrical distribution network simulation model;
- technical losses' reduction methods.

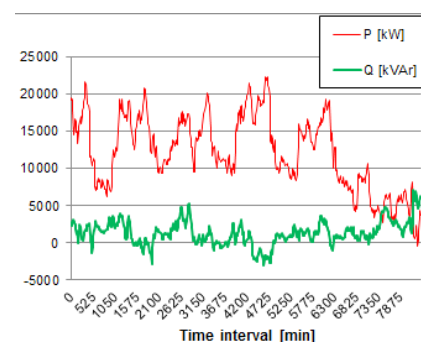

### Applicability and transferability of the results

The algorithm used for technical losses evaluation is able to be applied in case of any distribution network operator. Also, based on the achieved experience, other (or similar) technical losses reduction methods could be highlighted in case of other distribution operators.

### Fields of interest

- distribution network analysis;
- technical losses computing;
- loss reduction methods;
- distribution system operators.

### Research Centre

Research Centre for Power Systems Analysis and Optimization

### Financed through/by

Servelect Cluj-Napoca, total value: 12.000 RON

### Research team

Stefan KILYENI, Constantin BARBULESCU, Attila SIMO, Annamaria KILYENI

### Contact information

Prof. Dr. Eng. Ștefan KILYENI/ Ș. L. Dr. Eng. Constantin BARBULESCU  
 Department of Power Engineering  
 Address: Bd. Vasile Pârvan, No. 2, RO300223, Timisoara  
 Phone: (+40) 256 403 430/ (+40) 256 403 416  
 E-mail: stefan.kilyeni@upt.ro/ constantin.barbulescu@upt.ro

## ACTUAL TOPOLOGIES AND COMPONENTS FOR SINGLE-PHASE POWER FACTOR (PFC) FOR GRID TIED INVERTERS

### Goal of the project

The Customer is a leading supplier for grid-tied motor control inverters for residential White Good applications like washing machines. It expects the market for inverters in residential ambient with power levels of up to 4kW to grow fast. For these inverters a new interface for residential grids must be designed which is EMC-conform. White Good applications with a power level of up to 1 kW uses passive chokes to fulfill the harmonic limits for the mains current drawn from the grid. The Subject of this contract is the compilation of a study dealing with the analysis and evaluation of current topologies and solutions for the single phase power factor correction (PFC) for 230V mains voltage.

### Short description of the project

The evaluation of the current topologies was done in regards to electromagnetic compatibility (EMC) requirements including radio frequency interference (RFI) which is very important in the residential ambient. In a second step was decided if a standard PFC controller is used, or if the motor control DSC will also control the PFC power stage later on in the final design. For the 4 most promising topologies the efficiency versus output power (0-110%) calculation and filter requirement analysis (RFI and harmonics (EN 61000-3-2)) were done in an accurate approach to have a confident decision base. For these 4 topologies the losses in semiconductors (conduction and switching losses) and passive components (inductors, capacitors and EMI filter) were calculated. Two different topologies were selected by Diehl-Controls for prototype build for verification.

### Project implemented by

Diehl AKO Stiftung & Co. KG Germany

### Implementation period

10.01.2013 – 1.07.2013

### Main activities

- Analysis of actual publications for single phase power factor correction (PFC) for 230V mains voltage;
- Evaluation of current publications and state of the art in this field;
- Modeling and simulation.

### Research centre

Research Centre for Smart Energy Conversion and Storage

### Fields of interest

It regards the market of grid-tied motor control inverters for residential White Good applications like washing machines. For these inverters a new interface for residential grids must be designed which is EMC-conform. White Good applications.

### Financed through/by

Diehl AKO Stiftung & Co. KG Germany.

### Results

- Analyzing all relevant single phase power factor correction (PFC) topologies currently existing for the power range of 1.5 kW up to 4 kW (passive PFC, low-frequency active PFC, high-frequency active PFC - standard topologies, interleaved PFC, bridgeless PFC, soft-switching techniques (Zero Voltage/Current Switching ZVS/ZCS, Zero Voltage/Current Transition ZVT/ZCT));
- Analyzing the currently existing methods for switching patterns and current sensing with high speed controllers;
- A decision matrix was prepared for different topologies;
- Two different topologies were be selected by Diehl-Controls for prototype build for verification.

### Applicability and transferability of the results

Patentable inventions or parts in such inventions (hereinafter „inventions“) made by one or several employees of the University within the course of carrying out the study considered here shall be notified and offered for transfer to the Customer by the University forthwith. Simultaneously, the University shall make available to the Customer any and all information potentially relevant for a realistic evaluation of the intrinsic value of such invention – as far as possible in writing.

### Research team

- Associate Prof. Sorin Mușuroi (as project manager);
- Associate Prof. Alexandru Hedeș;
- Assistant PHD Mihaela Codruța Ancuț;
- Assistant Marcus Svoboda;
- Prof. Dorin Popovici;
- Prof. Nicolae Muntean.

### Contact information

Assoc.Prof. Sorin Mușuroi, PhD  
Faculty of Electrical and Power Engineering  
Address: Bd. Vasile Pârvan, No. 2, RO300223, Timisoara  
Phone: +40 256 403462  
E-mail: sorin.musuroi@upt.ro

## MONITORING THE QUALITY OF WATER USED IN DIALYSIS

### Goal of the project

The project objective is to monitoring the quality of water used in dialysis.

### Short description of the project

During the project various parameters of the water used for dialysis are analyzed periodical from samples collected by the beneficiaries. The analyzed parameters and the times for the samples collections are commonly agreed by the beneficiaries and by the execution team. The analysis of the main parameters for the monitoring the quality of water used in dialysis is necessary in order to assure that the obtaining process of water used in dialysis operate in the best conditions and the resulted water is in the frame of the parameters required by the current legislation.

### Project implemented by

Faculty of Industrial Chemistry and Environmental Engineering, Department of Applied Chemistry and Engineering of Inorganic Compounds and Environmental.

### Implementation period

01.01.2013-31.12.2013

### Main activities

During the project will be analyzed the concentration of the following parameters: Ca, K, Mg, Na, Al, Cu, Pb, Cr, Sb, As, Ba, Cd, F, Hg, NO<sub>3</sub><sup>-</sup>, NO<sub>2</sub><sup>-</sup>, Se, Ag, SO<sub>4</sub><sup>2-</sup>, Z n, from the network water, softened water and permeate. The main parameters are analyzed dailies and other are analyzed monthly in accordance with the achieving plan established by the both parts involved in the project.

### Research Centre

Research Centre for Environmental Science and Engineering

### Financed through/by

Research - Development and Consultancy Contract with S.C. VAMAGO S.R.L. and S.C. NEFROMED S.R.L.

### Research team

Lecturer Dr. Eng. Adina Negrea - director

### Results

The results of the project are represented by the establishment of the quality of water used in dialysis.

### Applicability and transferability of the results

The obtained results are useful for the assurance that the obtaining process of water used in dialysis operates in the best conditions and the resulted water is in the frame of the parameters required by the current legislation.

### Contact information

Assist. Prof. Adina NEGREA, PhD  
Faculty of Chemistry and Environmental Engineering  
Address: Bd. Vasile Pärvan, No. 6, RO300223, Timisoara  
Phone: (+40) 256 404 192  
Mobile: (+40) 723 649 897  
E-mail: adina.negrea@upt.ro



## MODELLING THE TWO-DIMENSIONAL SWIRLING FLOW IN FRANCIS TURBINES FOR OPTIMIZATION OF DRAFT TUBE PERFORMANCES WITHIN AN OPERATING RANGE

### Goal of the project

This first part of the project was aimed at the two-dimensional, steady, axisymmetric swirling flow computation downstream the Francis runner. In addition, the kinematic constraint associated with the relative flow angle at runner outlet is to be considered as close as possible to the runner blades trailing edge, through the novel concept of swirl-free velocity profile from hub to shroud.

### Short description of the project

When designing a new runner or refurbishing an existing one, the runner must be the best fit for the draft tube, i.e. the head loss in the draft tube should be as small as possible over an operating range. We aim at optimizing the runner outlet geometry, such that the swirling flow ingested by the draft tube will provide minimum weighted averaged head losses over a given operating range. We substitute the runner blade outlet geometry by the swirl-free velocity concept, and use minimum information for geometrical data and operating point. As a result, we define a small parameter space suitable for a-priori optimization of the turbine design.

### Project implemented by

The project was implemented by a team of both senior and junior researchers, within the Turbomachinery Hydrodynamics Division of the Research Centre for Complex Fluids Engineering, CFD Laboratory.

### Implementation period

2012–2013

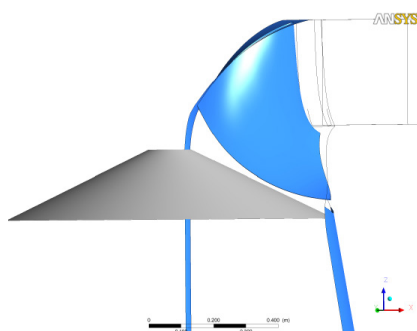

### Main activities

There were two main activities during the project:

- A1. Analysis of the 2D swirling flow downstream a Francis runner within the discharge cone:
- A2. Development of a 2D swirling flow code and code validation within a large operating range.

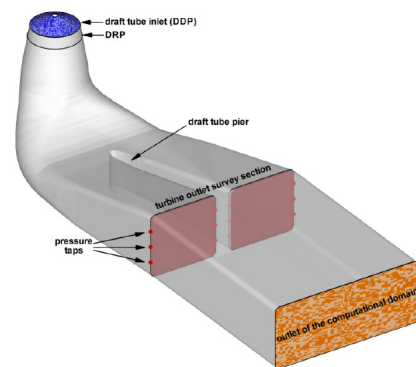

### Results

The main results can be summarized as follows:

1. Mathematical model for computing the swirling flow at the runner outlet (diagonal probing line in the neighborhood of runner blades trailing edge); it features the development of the stagnant region far from the best efficiency point through a novel variational formulation.
2. "TurboSwirlQ2D" computer code that solves the Bragg–Hawthorne equation taking into account the kinematic constraints at the blades trailing edge and integral constraints.

### Applicability and transferability of the results

The computer code "TurboSwirlQ2D" has been installed at Alstom Hydro France, Grenoble, to be used for a-priori optimization of the runner outlet geometry. The main advantage of the methodology developed in the project is that one can compute the swirling flow ingested by the draft tube at arbitrary operating points without computing the runner flow (before designing the turbine's runner).

## Financed through/by

ALST OM Hydro France, within the ALST OM-UPT Cooperation Agreement concerning the joint research and development projects related to assessing, developing and using mathematical and numerical modelling of the hydraulics of water turbines in a view to improve the performances of such turbines.



## Fields of interest

Hydraulic turbines hydrodynamics, optimization of the runner outlet for best performance of the draft tube within a wide operating range. Variational methods and numerical algorithms for swirling flows with vortex breakdown.

## Research Centre

Research Centre for Complex Fluid Systems Engineering

## Research team

Romeo Susan-Resiga, PhD, Professor  
Sebastian Muntean, PhD, Senior Researcher  
Alin Anton, PhD, postdoctoral fellow  
Tiberiu Ciocan, doctoral student  
Cosmin Ighisan, doctoral student

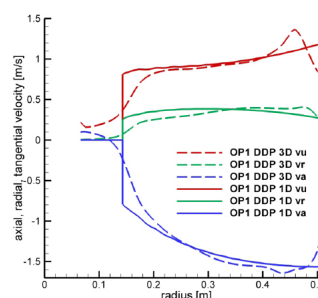

## Contact information

Prof. Romeo SUSAN-RESIGA, PhD.  
Department of Mechanical Machines, Equipment and Transportation  
Address: Bv. Mihai Viteazu, No.1, RO300222, Timisoara  
Phone: (+40) 256 403 689  
E-mail: romeo.resiga@upt.ro

## TECHNICAL DOCUMENTATION FOR THE WATER ADMINISTRATION PERMIT REGARDING THE DEVELOPMENT OF (1)- SMALL HYDROPOWER STATIONS ON TIMIȘ RIVER BETWEEN 550 AND 408 mSL AND (2)- SMALL HYDROPOWER STATION ON TEREGOVA RIVER BETWEEN 560 AND 450 mSL; BENEFICIARY SC SIBER ENERGIA SRL TIMIȘOARA

### Goal of the project

Documentation accomplished according to Bill of Water no.107/1996 and Standard Technical Documentation required for issuing a Water Administration Permit, organized by MMP Decree no.799/2011, MMGA Decree no.661/2006, Government Ordinance no.151/2005, Government Ordinance no.152/2005 and the Bill no.84/2006.

The mentioned documentation aims to obtain the Water Administration Permit for developing a group of two SHP stations on Timiș River – arrangement sector between 550 and 408 mSL and one SHP station on Teregova River respectively – arrangement sector between 560 and 450 mSL, both in Caras-Severin County.

### Short description of the project

Based on specific hydrological and morphological data supplied by the beneficiary and also considering the imposed spread limitation, the project studies the possibility of fitting some SHP stations on Timiș and Teregova Rivers.

Thus, the hydropower scheme on Timiș River would be of large and medium head derivation type, running by partially catchment of natural flow. The water development would be on two steps having the exclusive goal of power gaining: SHPS 1 – sector length of about 2860m between 550mSL ÷ 458mSL; SHPS 2 – sector length of about 2260m between 458mSL ÷ 409mSL.

The hydropower development designed to be accomplished on Teregova River would present one step with a headrace of about 3500m in length between 560mSL ÷ 450mSL.

### Project implemented by

SC SIBER ENERGIA SRL, 7th Victoriei Square, 300030 Timișoara, ROMÂNIA.

### Main activities

- The power stations fitment in the general arrangement - management scheme of the river basin, the working correlation, a locating study and the cooperation possibilities with respect to other hydrotechnical and sanitary works in the area;
- The establishment of importance class, of dimensioning and checking approaching probabilities respectively for the different elements, taking into consideration the flood protection with respect to the downstream socio-economical objects' importance;
- The study of hydropower potential gaining: options, estimated capacities, yearly average power production, specific hydropower parameters and markers;
- A view on the influence of the foreseen works upon the water courses and the specific objects in the area.

### Results

Accomplishment possibility for the following small hydropower stations:

SHPS 1 Timiș: minimum flow 0.39m<sup>3</sup>/s, average flow 1.19m<sup>3</sup>/s, installed discharge 2.08m<sup>3</sup>/s, 550mSL catchment, 458mSL machine, 1100mm diameter / 2860m length headrace, 1355kW installed power;

SHPS 2 Timiș: minimum flow 0.39m<sup>3</sup>/s, average flow 1.28m<sup>3</sup>/s, installed discharge 2.08m<sup>3</sup>/s, 458mSL catchment, 409mSL machine, 1100mm diameter / 2260m length headrace, 702kW installed power;

SHPS Teregova: minimum flow 0.118m<sup>3</sup>/s, average flow 0.591m<sup>3</sup>/s, installed discharge 1.418m<sup>3</sup>/s, 560mSL catchment, 450mSL machine, 800mm diameter / 3500m length headrace, 1007kW installed power;

Specific parameters defining the main elements composing the three SHPS are also established.

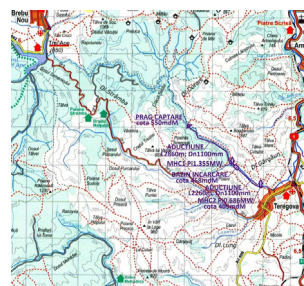

### Implementation period

January - October, 2013.

### Applicability and transferability of the results

In case of getting the Water Administration Permit, the study beneficiary looks to proceed for the accomplishment of the technical design and implementation details in order to perform the renewable energy investment and consequently to reach for the green certificates traded on the specific market.

## Fields of interest

- Renewable energy;
- small hydropower;
- water management;
- environment protection.

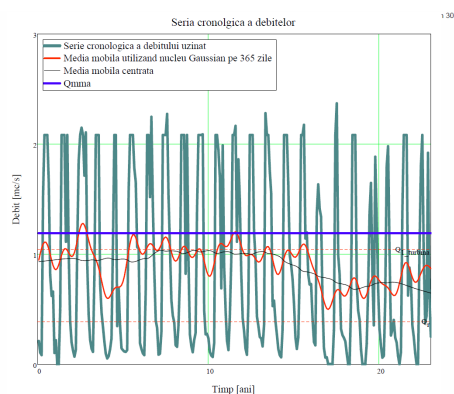
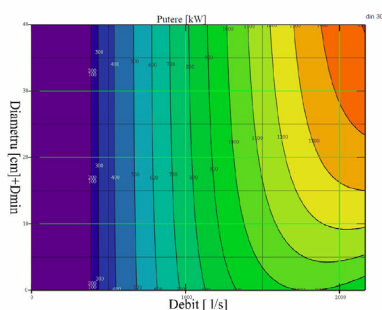

## Research Centre

Research Centre for Environmental Science and Engineering

## Financed through/by

Research, development and consultancy contract (€ 14,700 VAT included) signed with SC GEOLINK SRL.

## Research team

Albert Titus CONSTANTIN, lect.dr.eng., contract manager  
 Constantin FLORESCU, lect.dr.eng.  
 Șerban-Vlad NICOARĂ, lect.dr.eng.  
 Gheorghe LAZĂR, assist.prof.dr.eng.  
 Marie-Alice GHIȚESCU, assist.dr.eng.  
 Radu Lorin JUMANCA, assist.eng.

## Contact information

Assist. Prof. Albert CONSTANTIN, Ph. D.  
 Department of Hydrotechnical Engineering  
 Address: Str. George Enescu, No. 1/A, RO300022, Timisoara  
 Phone: (+40) 256 404 100  
 Mobile: (+40) 720 059 371.  
 E-mail: albert.constantin@upt.ro

## TECHNICAL EXAMINATIONS TO ESTABLISH CONSERVATION MEASURES FOR NADLAC-ARAD HIGHWAY LOT T2, KM 22+218... KM 38+882

### Goal of the project

The purpose of the technical examination was to establish the causes that led to the degradation of the Nadlac-Arad Highway, Lot T2, km 22+218... km 38+882 in construction (embankments degradation, degradation of the road superstructure works, erosion of engineering structure ends and so on) and to establish the solutions for conservation till resuming the construction works.

### Short description of the project

The contract constitutes the analysis of the performed projects for roads, embankments, bridges and passage ways, after which the field works were realized. On the basis of the performed surveying regarding the field degradations, technical examinations for infrastructure works were performed (embankments, superstructure works for the roads and for engineering structures). The technical examinations propose solutions for the conservation of the Nadlac-Arad Highway, Lot T2, km 22+218... km 38+882.

### Project implemented by

The project will be implemented by C.N.A.D.N.R. Bucuresti – D.R.D.P. Timisoara for the conservation of the Nadlac-Arad Highway, Lot T2, km 22+218... km 38+882 till resuming the construction works for the highway.

### Implementation period

01.2014-06.2014

### Main activities

Multidisciplinary activity domain, comprising chapters of road soil mechanics, roads and engineering structures.

### Results

By applying the solutions given by the Technical Examination, the resistance and the stability of the performed works will increase in order to stop in due time the degradation of the elements realized on the site.

### Applicability and transferability of the results

Based on the solutions given by the mentioned Technical Examinations, projects for conservation for each chapter separately will be performed.

### Fields of interest

Rectification and consolidation of the construction works for the highways.

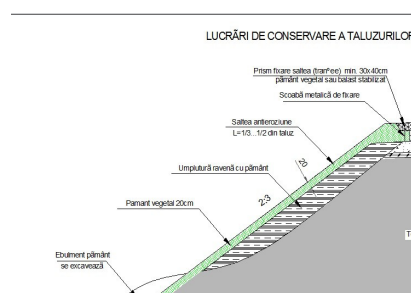

### Research Centre

Research Centre for Construction and Transportation Substructures

### Financed through/by

C.N.A.D.N.R. Bucuresti - D.R.D.P. Timisoara

### Research team

Project manager:

Professor Florin BELC, Eng. PhD.

Team members:

Professor Florin BELC, Eng. PhD.

Professor Gheorghe LUCACI, Eng. PhD.

Professor Marin MARIN, Eng. PhD.

Associate Professor Adrian BOTA, Eng. PhD.

Associate Professor Petru PANTEA, Eng. PhD.

Senior Lecturer Ciprian COSTESCU, Eng. PhD.

Senior Lecturer Monica MIREA, Eng. PhD.

Assistant Professor Paul MARC, Eng. PhD.

### Contact information

Professor Marin MARIN, Eng. PhD. – Head of Research Centre for Construction and Transportation Substructures

Phone: +40256403967

E-mail: marin.marin@upt.ro

Professor Florin BELC, Eng. PhD. – Head of Department of Overland Communication Ways, Foundations and Cadastral Survey

Phone: +40256403965

E-mail: florin.belc@upt.ro





# Patents



INVENTORS: MIRCI LIVIU-EDUARD  
PATENT NO. 128215/2013

## Biodegradable synthetic lubricants and process for preparing the same



The invention relates to a synthetic lubricant and to a process for preparing the same. According to the invention, the lubricant has the general formula I:  $R-COO-R-OOC-(CH_2)_n-COO-R-OOC-R$  where  $R_1$  is an ethylene glycol radical and  $R_2$  is an oleic radical of the formula:  $CH_2-(CH_2)_m-CH=CH-(CH_2)_n-$ , having a viscosity index in the range of 188...220, a fire point of 232...297 DEG C, a flowing point of -14...+28 DEG C, a wear spot diameter of 0.4...0.7 mm as related to the basic oil and of 0.35...0.66 mm for the adittivated oil.; The process, as claimed by the invention, consists, in a first stage, in contacting the sebacic oil with 2.01...2.1 mole ethylene glycol, in the presence of an aromatic solvent, in auto catalytic or catalytic system, extracting the reaction water for 10...150 h, followed by cooling the reaction mass down to 50...60 DEG C and, in a second stage, admixing the oleic acid in a stoichiometric ratio in relation with the diester, extracting the water for 10...95 h, removing the solvent from the installation, devolatilization under vacuum, treatment with active carbon and filtration.

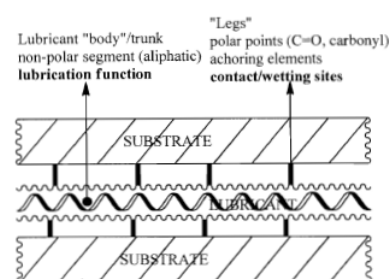

The regular alternation or successive distribution principle. "the myriapod" concept

**INVENTORS: ICLĂNZAN TUDOR-ALEXANDRU, STAN DANIEL VOICU**  
**PATENT NO. 123528/2013**

## Heated channel injection mould



The invention relates to an injection nozzle with closing needle comprised in heated channel moulds which are employed for manufacturing pieces of polymeric materials or thermoplastic composites and is intended to additionally heat the melt and seal the injection point, after the mould filling. According to the invention, the mould is provided, in front of the injection cavity, with an ante-chamber (2) and a final normalized injection nozzle (3) which is coaxial with an ultrasound assembly (A) with axial motion possibility whereto there is attached a needle-rod (4) having the role of ultrasonic wave guide concentrator and being provided with a side surface (f) along which the melt flows, as well as with a terminal tapered zone (c) ensuring the sealing of the nozzle (3) in the injection point (b), after filling the cavity.

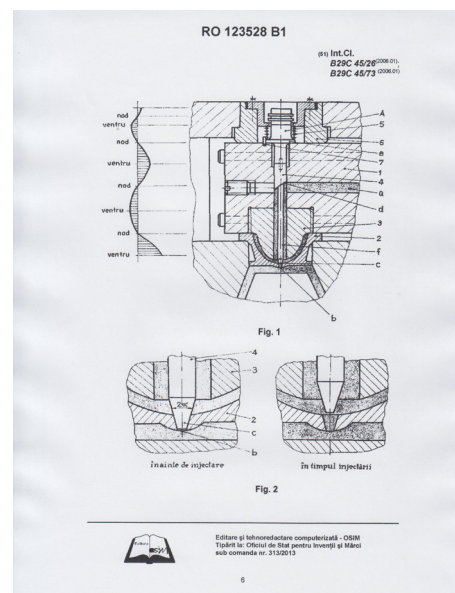

# Patent Requests





INVENTORS: GONTEAN AUREL-ȘTEFAN, CERNĂIANU MIHAIL OCTAVIAN

## INTELLIGENT CONTROL DEVICE FOR LIGHT SWITCHES

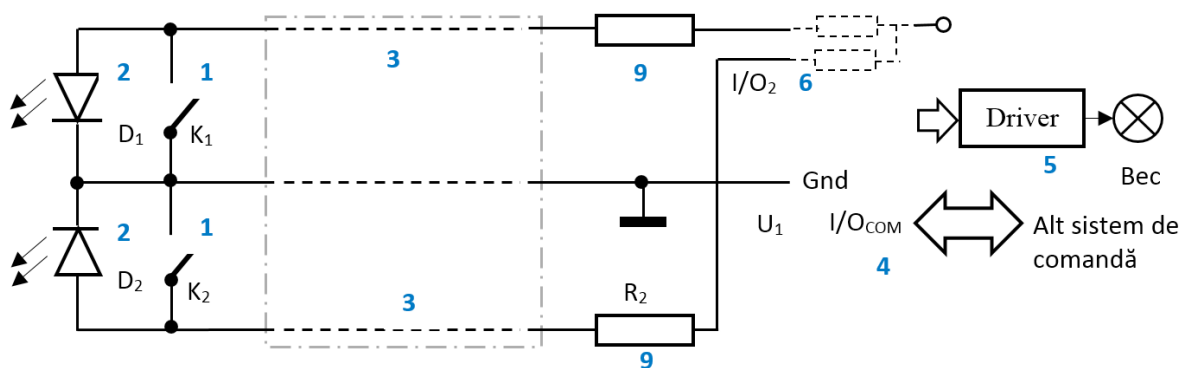

The invention relates to a light control switch integrated in a lighting system controlled by the microcontroller, for domestic or industrial premises lighting. The intelligent control device warning light switch invention is compatible with existing wiring in buildings where lighting is controlled by electronic systems, minimizing the energy consumed by the warning lights (comfort and safety elements), consisting of a microcontroller, a power driver block, classic switches (with return ) equipped with warning light (LED) optional wire connections and photo sensors , proximity sensors respectively.

The Intelligent light control switches invention has the following advantages :

- Removes the power dissipated in each warning light (about 0.5 W or 0,012 kWh daily )
- Simplicity
- Compatibility with intelligent lighting
- Compatibility with traditional wiring

INVENTORS: GONTEAN AUREL-ȘTEFAN, CERNĂIANU MIHAIL OCTAVIAN

## THERMO-ELECTRIC HYBRID SOLAR SYSTEM

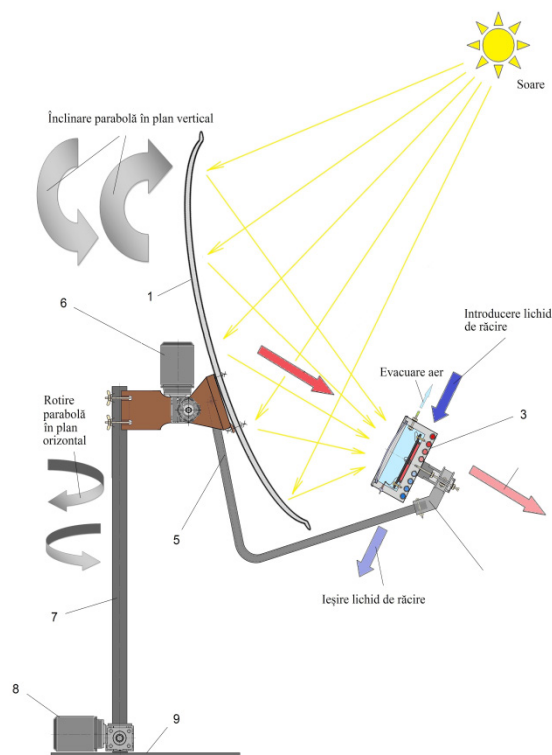

The invention relates to a solar thermal - electric hybrid, which produces hot water and electricity using thermoelectric modules.

Thermo-electric solar hybrid system according to the invention is composed of thermoelectric modules, and solar concentrator photovoltaic cells that convert heat to increase efficiency and reduce losses by convection, using a vacuum chamber that allows the positioning unit conversion at any position and allows adjusting the amount wastewater heat transferred by replacing hexagonal mirror solar concentrator photovoltaic.

The thermal solar-electric hybrid system according to the invention has the following advantages:

- protects the thermoelectric module enclosure from moisture and other natural elements by using the cylindrical shape vacuum device.
- decreases the thermal conductance of the thermoelectric modules by removing the air, thus preventing heat transfer between the hot and cold modules .
- decreases the overall thermal conductance of the thermoelectric conversion module by the use of fastening elements of the glass fiber .
- helps to reduce heat loss by convection due to the use of a vacuum environment.
- provides the possibility to adjust the amount of heat transferred to the assembly by replacing the selective conversion reflecting mirror photovoltaic cells.

INVENTORS: NANU SORIN, COICHECI COSMIN, CRECAN RAREȘ-CRISTIAN,  
DANCI PAUL VALENTIN, ILE VIRGIL SEBASTIAN

## HARDWARE AND SOFTWARE PLATFORM TO REMOTELY CONTROL AND MONITOR APPLICATIONS VIA THE INTERNET

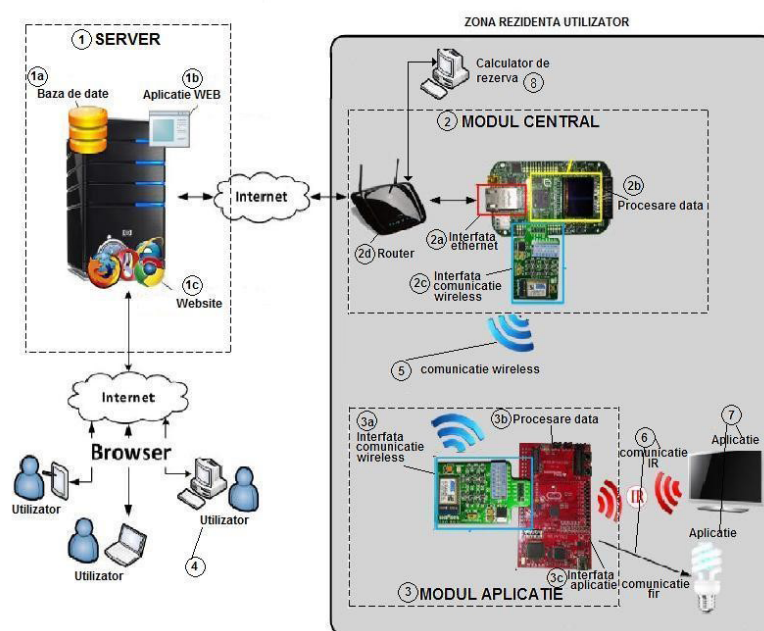

The invention relates to a device for monitoring and the automatic control of the domestic and industrial applications using modules wirelessly connected to the internet. All functions of this equipment can be carried out remotely via an Internet connection from a computer or cell phone. The problem solved by the invention is to realize a modular, easy to install and operate system for monitoring and automatization, for domestic and industrial applications placed at a user residence. The system can be developed by the user, giving him an effective framework for communication over the Internet, accessible from any computer or mobile phone.

Controlling equipment remotely via the Internet, the consumer and industrial applications of the invention consists of a base module, CENTRAL and several application modules that can be connected optionally . So the minimum configuration is :

One CENTRAL module and one or more APPLICATION module

This structure can be extended to any number of APPLICATION modules with a simple hardware connection, thereby ensuring modularity feature . Configuration of the software is very simple, with practically no user intervention.

The characteristic of simplicity is the fact that the operations required to perform a specific function by the user:

- No specific technical knowledge in IT , existing application modules , so no intervention of a team of specialists for installation;
- Are naturally suggestive
- Operations that are seemingly more complex are guided by the computer ;
- The application modules can be designed and configured by the user .

INVENTOR: PAVEL ŠTEFAN

## COMPRESSED AIR SYSTEM FOR DENTAL UNITS

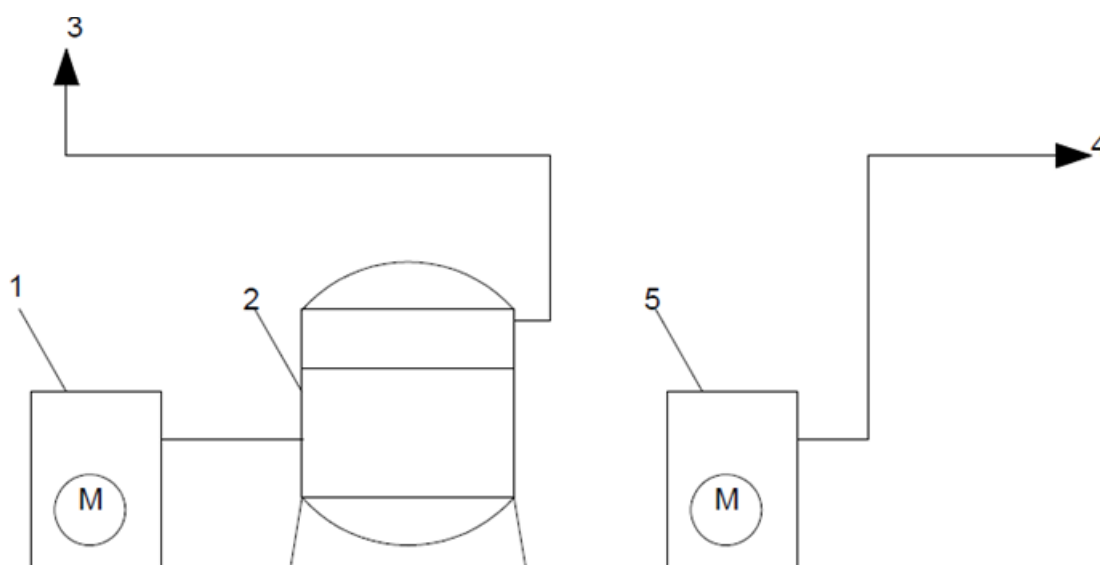

The invention concerns a compressed air system to be used in dental settings that serve multiple dental units.

The technical problem the new system intends to solve is how to automatically manage the distribution of compressed air from the compressed air system between 20.00 and 8 a.m. hours, so that the real needs of the permanent dental emergency compartment are met.

The new system consists of an assembly of devices for compressed air: valves, pressure regulators, manometers, one-way valves, „T” crossings and an automation with hourly and weekly programmer that controls an electric valve.

The new system has the following advantages:

- Increased energy efficiency, through lower energy consumption;
- Lower compressor stress;
- Reduces losses of compressed air in the main compressor unit;
- A safety measure to avoid the accumulation of bacteria (*Legionella pneumophila*), micro-organisms, air-transmitted viruses, that can appear when the air in the main reservoir is not used for a long period;
- Increased safety in functioning.

INVENTORS: SÎRBU NICUȘOR ALIN, ȘERBAN VIOREL-AUREL

## ULTRASONIC DEVICE FOR EVALUATION OF THE MELT FLOW OF POLYMERIC AND COMPOSITES MATERIALS

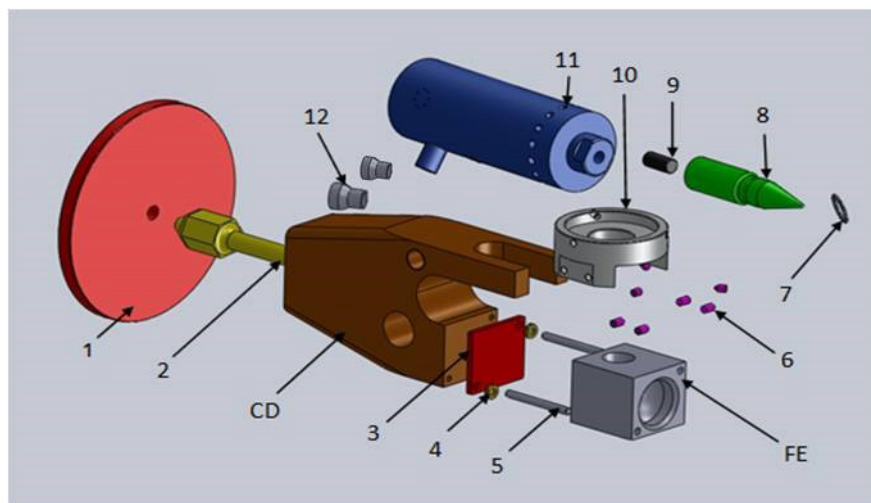

The invention relates to an ultrasonic device used for the evaluation of the melt flow of polymeric and composite materials, which can be used in academic, research and development areas, as well as in the chemical industry, in the manufacturing industry of polymeric materials and composites, in order to evaluate the flowing process due to the beneficial effects of the micro-vibrations with ultrasonic frequency, respectively the increase of the flow rate and reduction of the processing flaws. The ultrasonic device is built in a compact manner and can be easily positioned and fitted on classical processing equipment for polymeric materials by injection or extrusion.

According to the invention, the ultrasonic device for the evaluation of the melt flow rating of polymeric and composite materials is composed of an ultrasonic assembly (AU), which includes a piezoceramic transducer (11), a cone-headed cylindrical sonotrode (8), in steps, the fitting (9) and the heat-resistant silicone rubber ring (7) which seals and centres the ultrasonic assembly (AU) relative to the extrusion dies (FE).

Positioning, fixing and adjusting of the ultrasonic assembly (AU) in the device's body (CD) and in relation to the extrusion dies (FE), which provides also the technological parameter "flow gap - i", is realized either by positioning the holder (10) in relation to the device's body (CD), using a set of feeler gauge of different thickness or by using the screw-nut mechanism, fine-pitched, located in the assembly area of the support (10) and the piezoceramic transducer (11).

In both cases, the mounting of the adjusted position is realized with threaded bolts (6). The positioning and fixing of the ultrasonic device between the plates (fixed and mobile) of the injection or extrusion classic equipment of the polymeric materials or polymer composite melt is realized through the screw-nut mechanism (1 and 2) and the reducing or even eliminating the heat transfer between the device body (R) and the extrusion dies (FE) is carried out by using a thermal insulation textolit (3) and two distance plates (4), which are positioned by means of threaded head guides (5), which are fixed on the device's body (CD) in threaded borings.

Also, the ultrasonic device is equipped with an air cooling system (E) on the piezoceramic transducer (11) and on the device's body (CD); the fixation of the cooling system on the device's body (CD) is realized through rapid coupling (12).

It is mentioned that there is a possibility of the extrusion dies (FE) to be changed according to the technological requirements (size and shape) of the process. So interchangeability can be done easily, achieving a new product involving minimal costs.

INVENTOR: MANEA FLORICA

## ELECTRODE AND METHOD FOR FAST ELECTROCHEMICAL DETECTION OF ARSENIC (III) FROM AQUEOUS SOLUTIONS

The invention relates to the elaboration of an electrode and a process for the electrochemical detection of arsenic (III), a highly toxic pollutant from aqueous solutions. Also, the working electrode and the process of the invention can be used both for the detection of other pollutants from water (heavy metals and organic pollutants) and for other applications (the analysis of pharmaceutical products, food quality control and safety, clinical analysis).

The issue to be solved by the invention is to develop a product and a method based on the electrochemical method of fast detection of arsenic (III) from aqueous solutions using a relatively inexpensive electrode material, with a long operating time, exhibiting high electroanalytical performance – limit of detection, sensitivity, reproducibility, accuracy.

The electrode and the method of fast electrochemical determination of the arsenic (III) from aqueous solutions according to the invention consist on the use of an electrode called working electrode, a counter electrode in assembly with a reference electrode, which based on the anode stripping method and using the square wave voltammetry technique allow the contact with the arsenic (III) contaminated water in the presence of an electrolyte, leading to the working electrode electrochemical response in the presence of the pollutant. The working electrode is a composite electrode obtained by dispersing carbon nanotubes in a epoxy matrix and then, electrochemically modified with silver nanoparticles.

The electrode and the method of fast electrochemical detection of arsenic (III) from aqueous solutions according to the invention has the following advantages: very high electroanalytical characteristics (limit of detection, sensitivity, reproducibility, accuracy), low cost of materials used for the working electrode elaboration, long operating time (at least 1 year).

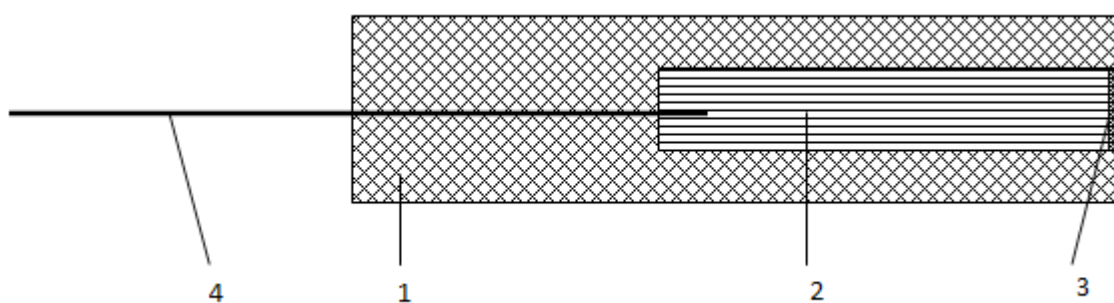

Figure 1. Schematic representation of the electrode

1-cylinder holder, 2-the active cylinder consisting of carbon nanofibers dispersed into an epoxy matrix, 3-a disc-shaped front side decorated by electrochemical deposition of silver nanoparticles, 4- copper wire to assure connection



INVENTOR: ICLĂNZAN TUDOR-ALEXANDRU

## MOULDS AND INJECTION PROCESS FOR MINIATURE PARTS

The invention relates to the field of manufacturing miniature parts made of polymeric materials with the injection molded process using ultrasound activation .

The problem to be solved by the invention is to realize an injection mold for the manufacture of as a miniature parts , to avoid the danger of uncontrolled solidification of the material in the areas of low flow to operation without the use of injection machines for the preparation and the polymeric material and ensure an injection cycle as short .

Injection mold and method according to the invention the miniature parts is made from a higher cell subansamblu includes the nodal region of the vibration fixing the resonator body in the  $\lambda / 2$  and the inside ensure a snug fit with the guided movement of a concentrate adapter wave  $\lambda / 2$  attached to a movable ultrasonic converter . The hub adapter wave  $\lambda / 2$  running in the mold during the movement to cut a portion of the polymeric material strip is inserted laterally into a space created in the concentrator and the inlet of the pills attached by screwing to the end of the body the resonator and the central bearing hole injection cuiburi. După cutting under the action of ultrasonic energy melts the polymeric material to a pellet is injected and the lower bearing parts nests . Lower pill nest cavities is attached by screwing the upper end of a second converter ultrasonic concentrator fixed nodal area concentrator in fixed lower mold assembly . Moving the upper mold assembly relative to the fixed lower assembly is guided by guide columns . Ultrasonic activation pill containing nests ensures lower energy production neccesara termopelicular ultrasonic effect throughout solidification preventing uncontrolled flow path and ensuring proper filling of the cavity nests with beneficial effects to mix the material quality and minimizing compliance injection time.

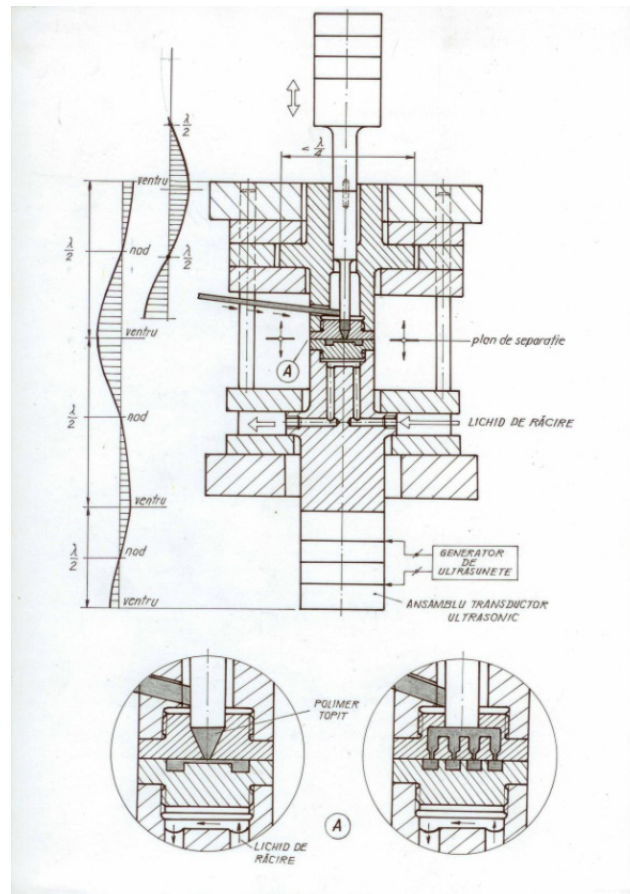

Injection mold and method of miniaturized components according to the invention has the following advantages :

- Ensure injection miniature parts without the use of injection molding machines of conventional design or adapted microinjection , which are expensive and bulky ;
- Ensures avoid uncontrolled solidification of the material injected into the mold to achieve miniature pieces can cool before completion of injection or breaks between cycles ;
- Ensure injection cycle times and thus optimize the process ;
- Ensure easy evacuation of molded parts from the mold and the conditions imposed on them by the quality and accuracy .



# Utility Models



INVENTOR: SEBARCHIEVICI CĂLIN

## AUTOMATIC CONTROL DEVICE FOR HEATING SYSTEMS

The technical problem solved by the invention is to provide a device for pump's speed control automatic adjustment based on monitoring the ambient temperature in order to optimize electrical and thermal energy in the system.

According to the invention, the automatic control device for heating systems ensures the speed control of the heating system supply pump through a programmable logic controller that uses information from interior and exterior temperature sensors. The command of the programmable logic controller is submitted to a frequency converter that commands the pump's speed and its start-stop function in order to reduce energy consumption. The automatic device for heating systems according to the invention has the following advantages:

- ensures the heating system optimization by automatic speed pump adjusting;
- provides thermal energy and electricity savings;
- leads to improved boiler efficiency (running on natural gas, oil or solid) that is used to prepare the thermal fluid for space heating;
- helps to improve the heat pump's (air-water, water-water or ground-water type) seasonal coefficient of performance.

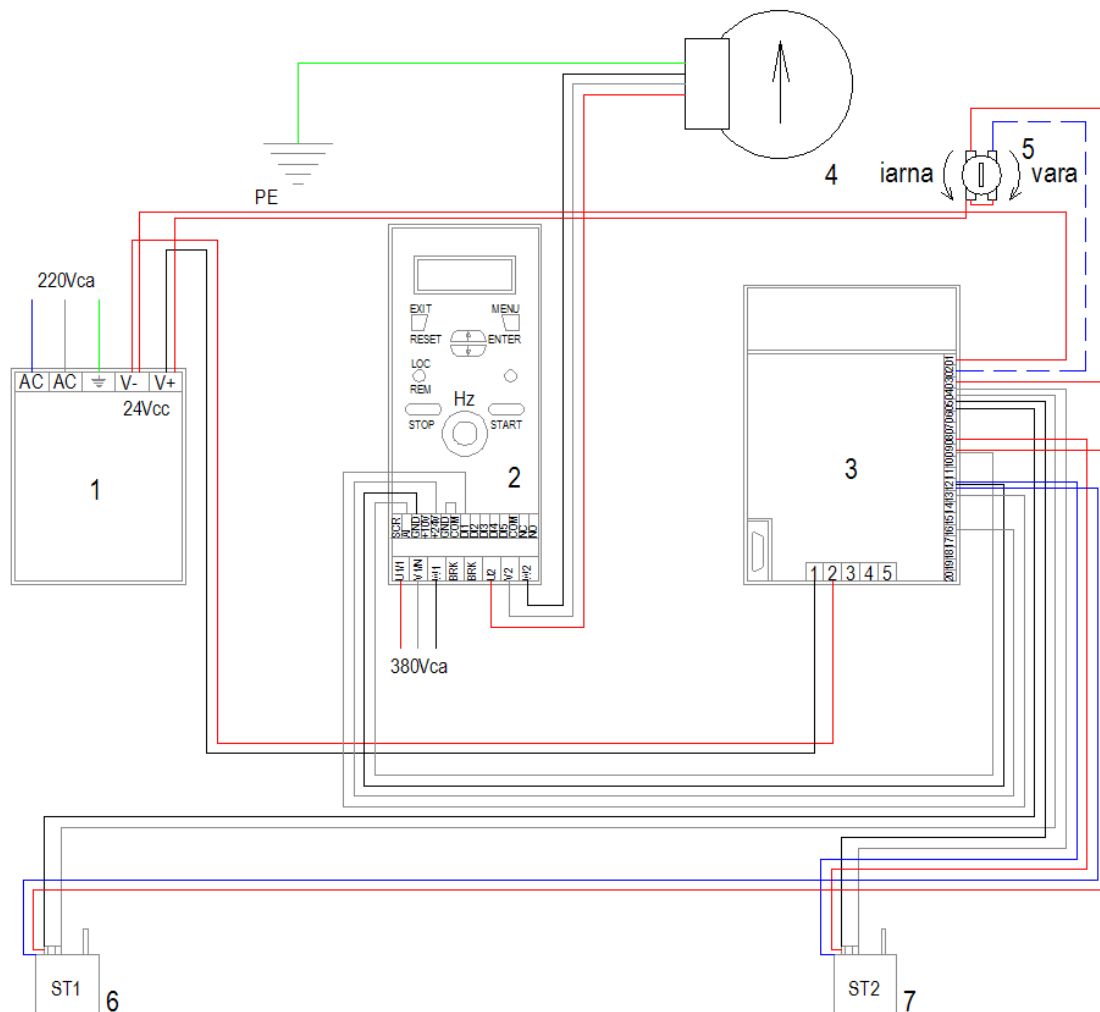

INVENTOR: PAVEL ŞTEFAN

## WASTE WATER DECONTAMINATION SYSTEM IN THE DENTAL UNIT



The invention concerns a system for the decontamination and treatment of waste water in the dental unit, water that is to be purged in the sewers. The technical problems to be solved regard the creation of a system that could, once attached to the dental unit, the collection of the contaminated waste water, its treatment and sterilization, and, finally, the evacuation of the water under hygienic and safety conditions. The system must perform the tasks simultaneously and efficiently.

The newly invented system to perform the decontamination of waste water from the dental unit, is composed of an assembly of closed and segmented (divided) recipients that are equipped with baffles that allow the injection of a air and ozone mix into a first set of decontamination activation cells, to be followed by further decontamination by UV germ-killing lamps (C class) in the next activation cells; and finally, evacuated into the sewer system when the physical, chemical and microbiological parameters are reached.

The newly invented system for the decontamination of waste water from the dental unit presents the following advantages:

- Uses decontamination agents produces into the installation (ozone) and long term use devices (germ-killing UV lamps);
- The decontamination is efficient as it uses just approx. 1kW/hour electrical energy for 16 hours of functioning;
- The maintenance operations are very simple and require just the replacement of germ-killing UV lamps after 10,000-15,000 hours of functioning;
- The system can be easily monitored while working;
- Safety during functioning;
- Allows for the avoidance of environmental pollution resulting from the use of chlorine as disinfectant.



INVENTOR: PAVEL ȘTEFAN

## LIGHTING SYSTEM FOR THE „CERAMIC ROOM” COMPARTMENT OF THE DENTAL LABORATORIES

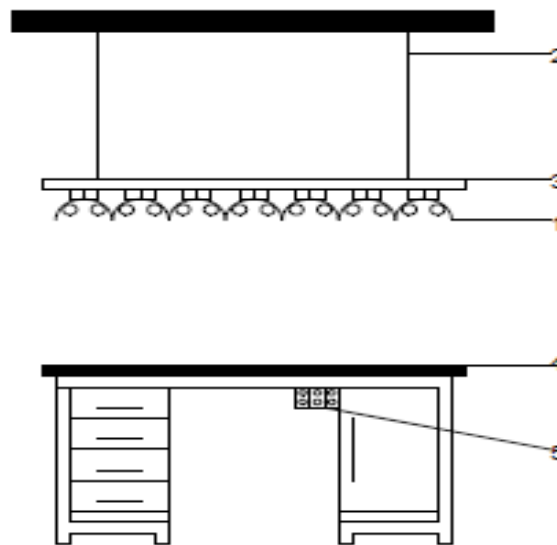

The invention consists of a lighting system to be used in dental laboratories, in the compartment known as „ceramic room”, where the dental ceramic works are processed.

The technical problem the new system solves is how to obtain an E [lx] lighting and colour temperature in the „ceramic room” that can be adapted to dental works realized in dental laboratories

The new system consists of 7 lighting units with mirror disperser, highly efficient electronic ballast and fluorescent lamps with a color rendering index (Ra) of 94 and a temperature of color rendering of 5200°K. The control of the „ceramic room’s” lighting system is in three steps, in order to provide variable light according to technological needs.

The new system has the following advantages:

- Provides optimal light on the work surface, according to the technological process mastered by the dental technician;
- Simple electrical control over the lighting;
- Safe functioning;
- High energy efficiency;
- Simple maintenance requirements.

INVENTOR: NEICU MARIAN ȘTEFAN

## ENGLISH LANGUAGE VOCAL INTERPRETER FOR ROMANIAN LANGUAGE SPEAKING USERS

The invention field refers to systems through which a vocal interpreter of English language is used by non-speakers of English language (for example speakers of Romanian language) with the help of the emulation of a keyboard through a software application installed on a computer.

The technical aspect of the invention consists in the creation of a system that allows the simultaneous use of the computer keyboard with some vocal orders transposed with the help of a microphone and of an integrated computer program, in orders equivalent to those from the keyboard.

According to the invention, the English language vocal interpreter for Romanian language speaking users consists in a microphone connected to a computer system on which is installed a software which is configured in the system so as to acknowledge only a set of controls which are sent to the application by pressing the keys or by pressing some key combinations for the purpose of carrying out the desired action. Thus, a user who knows the approximate pronunciation of the symbols on the keyboard in the language for which the vocal interpreter was designed, can replace the key pressing with their pronunciation at a microphone connected to a software on which the respective vocal interpreter is installed. Other controls may be used which do not require an exact pronunciation in the language for which the vocal interpreter was made.

According to the invention the English language vocal interpreter for speakers of Romanian language has the following advantages:

- Does not require good knowledge of the English language
- The software module which is the control module can be easily integrated in existent application, in order to provide an alternative control system. Its activation is controlled by the user, therefore there is no risk of occurrence of undesired controls.
- There are no software licenses costs involved for the vocal interpreter, as a free vocal interpreter can cope with success with the requirements imposed by the above mentioned application module.

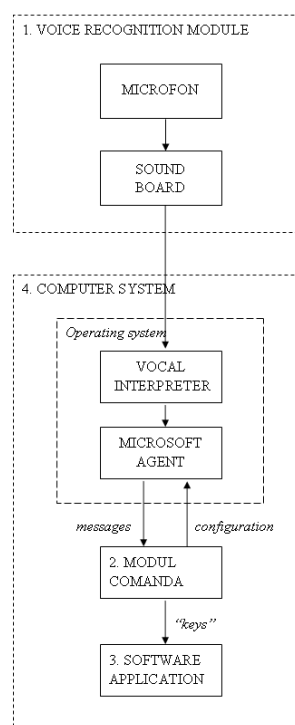

INVENTOR: DAN DANIEL

## GUTTER WITH DE-ICING SYSTEM

The invention refers to a gutter with automatic or manually operated de-icing system for removing icicles formation, especially in areas susceptible to public access.

The gutter equipped with the de-icing system according to the invention prevents icicles formation at its edge by using a flexible de-icing kanthal cable which is inserted by clamping/clinching inside the specially designed and configured edge of the gutter. The gutter segments have an open circular edge with an opening angle which enables un-cumbersome insertion of the de-icing cable, and in the overlapping area of gutter segments a transversal semi-louver exists, thus avoiding stiffening of this overlapping area and maintaining the clamping/clinching insertion capacity on the entire length of the overlapped segmental gutter. The de-icing cable is equipped at one end with an ice and snow sensor and a connector to a de-icing central command unit which enables the automatic or manually operation of the de-icing system.

The gutter equipped with de-icing system according to the invention presents the following advantages:

- straightforward and cheap construction
- maximum efficiency by focussing the heat at the edge of the gutter, at the base of icicles formation
- does not require any supplemental mechanical fastening components to fix the de-icing cable
- it allows for automated or manually operation
- ensures uniform and simultaneous de-icing on the entire length of the gutter
- un-cumbersome installation and maintenance

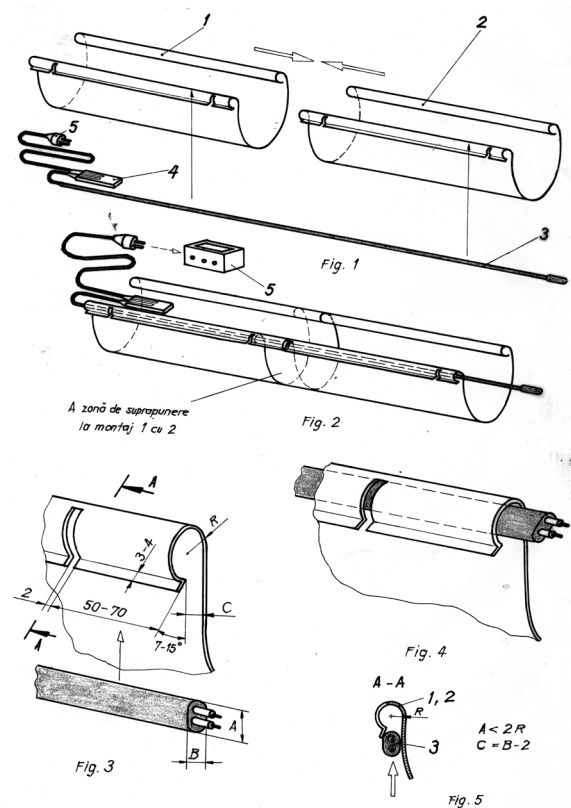

INVENTOR: ȘERBAN VIOREL-AUREL

## MANUFACTURING INSTALLATION OF CRUCIBLES FROM QUARTZ TUBES

The invention relates to a manufacturing installation of crucibles from quartz tubes used in the melting of metal alloys having high melting temperatures, or to the elaboration of amorphous alloys. According to the invention, the installation consists of a current generator converter type CTC (1) which supplies a transformer (2) and through this medium frequency currents are transmitted to a copper induction coil (3) which has inside a graphite sleeve (4) that plays the role of distributing and homogenize the thermal field generated by induction in the central axis of the inductor. Inside the graphite sleeve is introduced a quartz tube (5) which represent the preform that needs to be configured or reconditioned. It is fixed in position inside the graphite sleeve in working position through a mechanical fastening element (6) and is maintained in position or moved along the axis of the inductor by means of a guiding columns device (7). After fixing the quartz tube in working position, the heating is done by induction and when the optimal time for deformation is achieved the lower part is moved down and by means of a closing device (8) profiled in the active area supported on a stand (9), is obtained a truncated cone deformation of the quartz tube and at the same time the formation of a circular orifice or slot type.

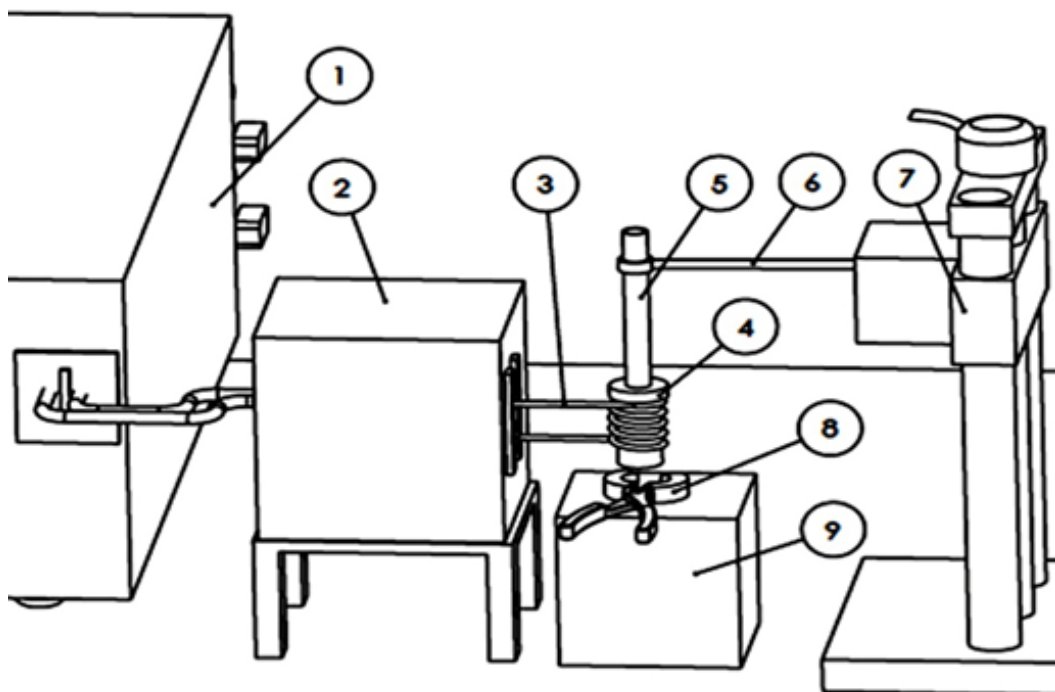

Fig 1. Installation overview

# Doctor Honoris Causa



## DOCTOR HONORIS CAUSA Prof. Gheorghiuța JINESCU - Politehnica University of Bucharest

Professor Gheorghiuța JINESCU, PhD, is a leading figure of the scientific community of chemists and chemical engineers in Romania, which she has served with dedication and energy throughout her a commendable professional career, extended over more than five decades.

Her exceptional academic career begins under the guidance of Academician Emilian A. BRATU with the thesis Properties and structure of the vibrated fluidized bed (1970).

In 1982, she becomes the first female university professor of chemical engineering in Romania.

Concerned with the dissemination of original scientific work, Professor Gheorghiuța JINESCU has published 13 books, more than 200 ISI papers, 344 scientific papers at national and international congresses and conferences. She has involved herself with enthusiasm and dedication in various activities dedicated to the development of higher education and training of exceptional future specialists in chemical engineering.



## DOCTOR HONORIS CAUSA Prof. Hubert Josef ROTH, PhD - University of Siegen

Professor Hubert Josef ROTH, PhD, of the University of Siegen, is a leading figure of the international scientific community. Through his high value academic career, the scientific work and the rich activity of promoting international academic institutional connections he is a prominent representative of the national and global engineering sciences.

In 1983 he becomes Doctor in Sciences with the thesis System order reduction techniques and their applications in adjustment systems. Until 1988, he works at Dornier aerospace company, today embedded within Airbus consortium, where he designs and tests the position and motion adjustment systems of the German-Anglo-American ROSAD astronomic satellite with X-ray telescope and contributes to the design of two other minisatelites.

In 1988, he becomes professor in Electrical Engineering at the University of Applied Sciences Ravensburg-Weingarten where he excels in promoting and developing international collaborations, such as Belarus (1996), Romania (1998), Azerbaijan (2002), Bulgaria (2006), Ukraine (2008), Laos (2006-2009, 2008-2011), Southeast Asia (Laos-Thailand-Hanoi, 2011-2014) or Latin America (Argentina, Brazil, Chile, Paraguay, El Salvador and Costa Rica).





## DOCTOR HONORIS CAUSA

### Prof. Burkhard Joachim CORVES - Rheinisch-Westfälische Technische Hochschule

Professor Burkhard Joachim CORVES, PhD, from the Rheinisch-Westfälische Technische Hochschule is one of Germany's outstanding scientific personalities, University Professor and Director of the Department of Mechanism Theory and Machine Dynamics at RWTH Aachen.

A resonant name in research at global level, he obtained his PhD with the thesis Simulation of the kinematic and dynamic behavior of manipulators with partially closed kinematic chains.

In 1998 he was elected as Chairman of the Scientific Committee of the biannual Conference of Mechatronics VDI/VDE and, since 2002, he is vice president of the Scientific Board of the Journal Mechanism and Machine Theory.

Along his academic and research activities, Professor Burkhard Joachim CORVES published 11 books and chapters in books, about 200 scientific papers, led more than 60 research projects and is the author or co-author of 21 patents.



# Habilitation Theses



## APPLIED RESEARCHS ON MULTIFREQUENCY SIGNAL PARAMETERS ESTIMATION, ANALOG-TO-DIGITAL CONVERTERS DYNAMIC TESTING, AND SYNCHROPHASORS ESTIMATION

Author: Daniel-Cornel BELEGA

### Abstract

In the habilitation thesis the main professional and research results achieved during the period 2002 - 2013 are presented. In the aforementioned period the main research fields were: Signal Processing, Analog-to-Digital Converter (ADC) Testing, and Synchrophasor Measurements.

In the Signal Processing the parameter estimation of a sine-wave by the frequency-domain methods - Interpolated Discrete Fourier Transform (IpDFT) method and the Energy-Based (EB) method - and the sine-fitting algorithms is analyzed. The statistical performance of each above frequency-domain method is analyzed. Furthermore, two multipoint IpDFT methods for frequency estimation are described and their performances are compared. Besides, the expression of the combined standard uncertainty of the frequency estimator achieved by the most suited to be used in practice multipoint IpDFT is given. Then, the performance of the average-based IpDFT method is presented. Also, the effectiveness of a multipoint IpDFT method for amplitude estimation as compared with the IpDFT method is revealed. The results of the comparison between the theoretical means of the sum-squared fitting and residual errors achieved by the three-parameter sine-fitting (3PSF) algorithm with frequency a-priori estimated by the IpDFT method (3PSF-IpDFT algorithm) and the four-parameter sine-fitting (4PSF) algorithm are presented.

In ADC Testing is investigated the estimation accuracy of some of the most important dynamic parameters of an ADC, which are the Effective Number Of Bits (ENOB) and Signal-to-Noise And Distortion ratio (SINAD), achieved by means of the frequency-domain and time-domain sine-fitting algorithms when the sine-wave test signal is non-coherent sampled. The procedure used to estimate the SINAD and ENOB parameters by a sine-fitting algorithm is given. Then, the expressions for the mean and variance of the ENOB estimates provided by a sine-fitting algorithm are presented.



In Synchrophasor Measurements the synchrophasor estimation achieved by some DFT-based estimators in the case of an electrical signal with decaying dc offset component are presented. The performance of the IpDFT synchrophasor estimator is also presented in the habilitation thesis.

The full abstract at:

[http://www.upt.ro/pagina\\_indep.php?cat=nu\\_pagini&id=eBBLH](http://www.upt.ro/pagina_indep.php?cat=nu_pagini&id=eBBLH)

### Habilitation Commission

Prof. Gheorghe ȘTEFAN  
Universitatea Politehnica din București ;  
Prof. dr. ing. Daniela TĂRNICERIU  
Universitatea Tehnică "Gh. Asachi" din Iași;  
Prof. dr. ing. Corneliu RUSU  
Universitatea Tehnică din Cluj-Napoca.

## APPLIED RESEARCH ON HIGH IMPEDANCE SURFACES AND SIGNAL PROCESSING

**Author:** Aldo DE SABATA

### Abstract

This work is mainly focused on research results obtained by the author in the field of Applied Electromagnetics between 2009 and 2013. Signal Processing, which is another research area approached in the past, is also covered.

Activity in the field of Applied Electromagnetics has been directed to (i) applications of Metamaterials with electromagnetic band-gap(s), (ii) calculation of forces in magnetic fluids environment and (iii) education.

The history of Metamaterials is about a decade long. This direction of research has been approached in 2009. Several fixed and switched planar structures with potential applications in filtering and signal integrity have been devised.

Restoring forces in magnetic fluids bearings have been calculated by using several models and approximations in view of validation.

In Signal Processing, work and results can be grouped in two categories (i) spectral analysis and (ii) sampling theory.

The section on Applied Electromagnetics contains a review of the field of metamaterials introduced in order to motivate the framework of the activity. A selection of relevant results in fixed, planar structured surfaces acting like Metamaterials with electromagnetic band-gaps is presented, followed by another subsection containing results on switched surfaces. The second part of the section on Applied Electromagnetics is dedicated to results obtained in calculation of restoring force in magnetic fluid bearings with poles on the stator and on the rotor (shaft). Plane-parallel and plane-meridian models for the magnetic field are used in order to compare the predictions in view of validation of results concerning the evaluation of the restoring force.

In the section concerning Signal Processing, two algorithms that significantly improve the frequency estimation of sinusoids embedded in white Gaussian noise are presented. The algorithms are evaluated in the small sample case and asymptotically and results of computer experiments are reported in order to demonstrate the effectiveness of the proposed methods.

Results in Sampling Theory of multi-dimensional signals are



then reviewed. These results are a continuation of the author's doctoral work. The selected signal model consisted of complex, multidimensional, band-limited periodic and finite energy signals sampled along non-orthogonal axes. The author proposed several sampling procedures at the minimum sampling density and the corresponding reconstruction methods. A sampling theorem for band-limited, complex periodic signals is stated and demonstrated. Sampling is performed on non-orthogonal directions. Finite-energy, complex, band-limited signals with spectrums containing gaps have been considered in view of finding sampling procedures at the minimum Shannon-Landau sampling density. Examples in the cases of derivative sampling and delay-systems sampling are provided. The aliasing error is evaluated and aliasing error bounds are reported. The report is concluded with perspectives on future work in the newly equipped Laboratory of Microwaves, Antennas and Electromagnetic Compatibility.

The full abstract at:

[http://www.upt.ro/pagina\\_indep.php?cat=nu\\_pagini&id=eBbLH](http://www.upt.ro/pagina_indep.php?cat=nu_pagini&id=eBbLH)

### Habilitation Commission

Prof. Ioan NICOLAESCU  
Military Technical Academy, Bucharest, București  
Prof.dr.ing. Daniela TARNICERIU  
Technica University "Gh. Asachi" Iași  
Prof.dr.ing. Beatrice PESQUET  
Télécom Paris Tech, France.

# PhD Theses





## Industrial Engineering

<b>Eduard Arthur BERGER</b> Supervisor prof. L. Miloș	<i>Tehnici avansate de realizare a unor îmbinări sudate din materiale polimerice disimilare</i> (Advanced Technics for Achivement Disimilar Welds from Polimeric Materials)
<b>Liviu-Ioan HERMAN</b> Supervisor prof. D. Țucu	<i>Optimizarea sistemelor tehnologice pentru utilizarea energiei din surse regenerabile în procesul de încălzirea clădirilor</i> (Optimization of Renewable Energy Technological Systems Used for Heating Buildings)
<b>Elena Stela MUNCUȚ</b> Supervisor prof. D. Dehelean	<i>Optimizarea procesului de sudobrazare MIG/MAG-CMT a îmbinărilor disimilare din table subțiri</i> (Optimization of MIG/MAG-CMT Weld-Brazing Joining Process of Dissimilar Thin Sheets)
<b>Irina Daniela DURAN</b> Supervisor prof. C.D. Dumitrescu	<i>Managementul externalizării proceselor și serviciilor, componentă a activității întreprinderilor</i> (The Outsourcing Management of Processes and Services, Part of Enterprise Activity)
<b>Dacian Ionuț ȚENȚ</b> Supervisor prof. C. D. Dumitrescu	<i>Restructurarea sistemelor de producție</i> (Restructuring of Production Systems)

## Mechanical Engineering

<b>Florina MOLDOVAN</b> Supervisor prof. V. Dolga	<i>Cercetări privind analiza și sinteza unui mecanism cu bare pentru construcția unui robot mobil pășitor</i> (Research Regarding Analysis and Synthesis of a Bar Mechanism for the Construction of a Mobile Walking Robot)
<b>Andrei COMȘA</b> Supervisor prof. I. Maniu	<i>Contribuții privind automatizarea procesului de manipulare a cărților în biblioteci</i> (Contributions Regarding the Automation of Books Handling in Libraries)
<b>Adrian KARABENCIOV</b> Supervisor prof. I. Bordeășu Supervisor prof. I. Mitelea	<i>Cercetări asupra eroziunii produse prin cavitație vibratorie la oțelurile inoxidabile cu conținut constant în nichel și variabil în crom</i> (Research on Erosion Produced by Vibratory Cavitation to Stainless Steels with Constant Nickel Content and Variable Chromium Content)
<b>Irina Georgeta MOISĂ</b> Supervisor prof. R. Susan-Resiga	<i>Analiza și optimizarea curgerii pentru proiectarea inversă a turbomașinilor hidraulice</i> (Flow Analysis and Optimization for Turbomachinery Inverse Design Method)
<b>Tiberiu STANCIU</b> Supervisor prof. M. Nagi	<i>Cercetări termice și fluidodinamice ale tuburilor de tip Bayonet</i> (Thermal and Fluid-Dynamics Research for Bayonet Type Tubes)
<b>Raul Miklos KULCSAR</b> Supervisor prof. L. Mădăras	<i>Cercetări ergonomice asupra comportării coloanei vertebrale a conducătorului auto</i> (Ergonomic Research Regarding the Spine Behaviour During the Drive)
<b>Eugen-Dumitru BUȘA</b> Supervisor prof. I. Nicoară	<i>Contribuții privind creșterea siguranței transportului rutier de mărfuri periculoase</i> (Contribution Regarding the Safety of Road Transportation for Dangerous Goods)
<b>Ileana-Angelica ENKELHARDT</b> Supervisor prof. N. Faur	<i>Studii de optimizare a interacțiunii mecanice dintre stent și vasele coronariene</i> (Optimization Studies of Mechanical Interaction Between Stent Grafts and Coronary Arteries)
<b>Mihaela AMARANDEI</b> Supervisor prof. I. Nicoară	<i>Contribuții privind implementarea investigației termografice în cercetarea din domeniul tehnic și medical</i> (Contributions to the Implementation of Thermography Investigations Research in Technical and Medical Field)

**George Daniel PICIOREA**  
Supervisor prof. D. Iorga

*Contribuții la adaptarea unui sistem de injecție pentru folosirea combustibililor lichizi neconvenționali la un M.A.C. cu injecție directă*  
(Contributions to Injection System Fit for Unconventional Liquid Fuels Use in a Compression Ignition Engine With Direct Injection)

**Claudia Eudora TOMESCU**  
Supervisor prof. I. Ionel

*Cercetări privind optimizarea integrării unei instalații de captare CO<sub>2</sub> la blocul energetic de 330 MW pe lignit*  
(Research Activities Regarding the Optimum Integration of a CO<sub>2</sub> Capture Instalation to a 330 MW Unit on Lignite)

**Lucian BOGDAN**  
Supervisor prof. N. Faur

*Cercetări privind reconstrucția ligamentului încrucișat anterior al genunchiului*  
(Research Regarding the Reconstruction of the Anterior Cruciate Ligament of the Knee)

**Karla-Noemy BERDICH**  
Supervisor prof. N. Faur

*Cercetări privind modelarea numerică a patologiilor de natură mecanică ale membranei timpanice*  
(Research Regarding the Numerical Modeling of the Tympanic Membranes Pathologies of Mechanical Nature)

**Alexandru TOCARCIUC**  
Supervisor prof. L. Bereteu

*Contribuții la dezvoltarea unor metode de detectare a defectelor la structuri mecanice și echipamente rotative bazate pe analiza semnalelor vibro-acustice*  
(Contributions to Development of Methods for Fatigue Damage Detection in Structures and Rotating Machinery by Vibro-Acoustic Analysis)

## Chemical Engineering

**Elida Cristina ILINOIU**  
Supervisor prof. R. Pode

*Carbon-Based Composite Materials for Electrochemical Sensors and Biosensors*

**Constantin Claudiu VĂDUVA**  
Supervisor prof. N. Vaszilcsin

*Influența unor amine aromatice asupra cineticii proceselor catodice de depunere a cuprului și de degajare a hidrogenului din soluții pe bază de acid sulfuric*  
(Influence of Some Aromatic Amines on the Kinetics of Copper Deposition and Hydrogen Evolution Cathodic Processes from Sulfuric Acid Solutions)

**Amalia Corina MACARIE**  
Supervisor prof. G. Burtică

*Cercetări privind obținerea bioetanolului prin procedee inovative de pretratare și hidroliză a biomasei lignocelulozice*  
(Studies Regarding the Obtaining of Bioethanol by Innovative Procedure of Pretreatment and Lignocelluloses Biomass Hydrolyses)

**Mihalea UNGUREAN**  
Supervisor prof. F. Peter

*Pretratarea și hidroliza enzimatică a materiilor prime celulozice în vederea obținerii de zaharuri fermentescibile utilizate la obținerea bioetanolului*  
(Pretreatment and Enzymatic Hydrolysis of Lignocellulosic Biomass into Fermentable Sugars for Bioethanol Production)

**Nicoleta Luminița JURJ**  
Supervisor prof. G. Burtică

*Evaluarea și aplicarea nămolului orășenesc în scopul fertilizării unor site-uri distruse antropogen și a acoperirii rapide cu straturi vegetale stabile*  
(Evaluation and Application of Sewage Sludge for Fertilization of Sites Destroyed Anthropogenic and Fast Coating Layers Fixed Vegetable)

**Cosmina-Mariana MILITARU**  
Supervisor prof. T. Todinca

*Contribuții la modelarea și simularea instalațiilor de potabilizare a apelor de suprafață*  
(Contributions to the Modeling and Simulation of Surface Water Drinking Facilities)

**Ștefan Dănică NOVACONI**  
Supervisor prof. N. Vaszilcsin

*Contribuții la dezvoltarea celulelor fotoelectrochimice pe bază de dioxid de titan nanostructurat și colorant*  
(Contributions to the Development of Photoelectrochemical Cells Based on Nanostructured Titanium Dioxide and Dye)

**Agnes JAKAB**  
Supervisor prof. R. Pode

*Procese de oxidare hibride pentru eliminarea poluanților organici refractari din apele reziduale*  
(Hybrid Oxidation Processes for Removal of Refractory Organic Pollutants from Wastewater)

## Materials Engineering

**Iosif HULKA**  
Supervisor prof. V. A. Șerban

*Microstructural Characteristics, Wear and Corrosion Behaviour of HVOF and HVOF Sprayed Cermet Coatings*

**Relu-Costel CIUBOTARIU**  
Supervisor prof. V. A. Șerban

*Straturi de acoperire pulverizate termic în vederea creșterii rezistenței la eroziunea cavitațională*  
(Thermally Sprayed Coatings in View of Growth Resistance to Cavitation Erosion)

**Ramona Monica DOBRA**  
Supervisor prof. I. Mitelea  
Supervisor prof. V. A. Șerban

*Wear and Corrosion Behaviour of Duplex Treated Mechanical Parts*

**Florin Marian CORNEA**  
Supervisor prof. V. A. Șerban

*Studii și cercetări privind caracterizarea mecanică a aliajelor metalice amorfe prin solicitări statice de scurtă durată*  
(Mechanical Characterization of Amorphous Metallic Alloys by Static Short-Terms Test)

**Roxana Marcela BĂBUȚĂ**  
Supervisor prof. I. Lazău

*Utilizarea precursorilor polimerici în sinteza compușilor oxidici*  
(The Use of Polymeric Precursors in the Oxide Compounds Synthesis)

**Vasile Alin BĂEȚAN**  
Supervisor prof. I. Sporea

*Studii și cercetări privind influența microadaosurilor și tratamentelor termice asupra refractarității aliajelor de aluminiu*  
(Studies and Researches on the Influence of Heat Treatments on Refractory Properties and Additions Elements for Aluminum Alloy)

**Adriana TETILEANU**  
Supervisor prof. T. Hepuț

*Cercetări privind rafinarea oțelului elaborat pe fluxul cuptor cu arc electric-oală cuptor-turnare continuă*  
(Researches Regarding the Steel Refining on the Electronic Arc Furnace-Ladle Furnace-Continuous Casting Technological Flow)

**Eugen Mihai CRIȘAN**  
Supervisor prof. T. Hepuț

*Cercetări privind valorificarea în siderurgie a deșeurilor pulverulente și mărunte cu conținut de fier și carbon*  
(Researches on the Use of Powdery and Small Grain Waste That Contain Iron and Carbon, in Steel Making)

**Constantin ANDRONACHE**  
Supervisor prof. T. Hepuț

*Cercetări privind îmbunătățirea calității oțelurilor destinate fabricării componentelor materialului rulant*  
(Researches on Improving the Quality of Steel Meant for Rolling Stock Components)

**Daniel Horațiu URȘU**  
Supervisor prof. I. Grozescu

*Instalație și metodă de sinteză hidrotermală a oxizilor cu structură delafossitică de tipul  $CuM1-xNxO2$  pe bază de metale de tranziție*  
(Installation and Hydrothermal Synthesis Method of Oxides the Type  $CuM1-xNxO2$  with Delafossite Structure Based on Transition Metal)

**Cosmin Nicolae VANCEA**  
Supervisor prof. I. Lazău

*Noi soluții de imobilizare a unor deșeuri industriale în matrici vitroase*  
(New Solutions for the Industrial Wastes Immobilization Using Vitreous Matrix)

**Cosmin Florin GROZA**  
Supervisor prof. I. Mitelea

*Cercetări asupra procesului de realizare a îmbinărilor sudate eterogene, aliaj de titan-oțel inoxidabil austenitic*  
(Research on the Obtaining Process of Heterogeneous Welded Joints, Titanium Alloy-Austenitic Stainless Steel)

## Electronics and Telecommunication Engineering

**Mihail Octavian CERNĂIANU**  
Supervisor prof. A. Gontean

*Analysis of Thermoelectrical Modules for Energy Harvesting Systems*

**Cosmin CÎRSTEA**  
Supervisor prof. A. Gontean

*Contributions to the Efficient Use of Wireless Sensor Networks in Disturbed Environments*

**Arpad IOZSA**  
Supervisor prof. I. Naforniță

*Contribuții la îmbunătățirea recepției semnalelor utilizând algoritmi DOA și beamformingul adaptiv*  
(Contribution to Signal Reception Improvement, Using DoA Algorithms and Adaptive Beamforming)

**Jamal MOUNTASSIR**  
Supervisor prof. A. Isar

*Contributions to LTE Implementation*

**Ionuț Alexandru MIREL**  
Supervisor prof. V. Tiponuț

*Metode de prelucrare digitală a imaginilor video*  
(Digital Processing Methods of Video Images)

**Andy Răzvan VESA**  
Supervisor prof. I. Naforniță

*Contribuții la îmbunătățirea performanțelor sistemelor de antene*  
(Contributions to the Performances Improvement of Array Antennas)

## Power Engineering

**Petru Dan CRISTIAN**  
Supervisor prof. Ș. Kilyeni

*Planificarea extinderii sistemelor electroenergetice complexe utilizând tehnici de inteligență artificială*  
(Power System Expansion Planning Using Artificial Intelligence Techniques)

**Claudiu Florin SOLOMONESC**  
Supervisor prof. P. Andea

*Planificarea extinderii rețelelor de transport al energiei electrice utilizând tehnici de calcul evolutiv*  
(Transmission Network Expansion Planning Using Evolutionary Computation)

**Adrian Flavius OLARIU**  
Supervisor prof. F. D. Șurianu

*Integrarea pilelor de combustie de tip PEM în aplicații mobile și staționare*  
(Integration of the PEM Fuel Cells in Mobile and Stationary Applications)

## Computers and Information Technology

**Gabriela MĂGUREANU**

Supervisor prof. I. Jian

*Visual Modeling of Cyber Physical Systems*

**Marius Simion CRISTEA**

Supervisor prof. N. Robu

*Tehnici pentru sporirea rezistenței în fața atacurilor DOS și DDOS prin protocoale PROOF-OF-WORK, localizare și amprentare*

(Techniques for Increasing the Resilience Against DOS and DDOS Attacks Through PROOF-OF-WORK Protocols, Localization and Fingerprinting)

**Casandra HOLOTESCU**

Supervisor prof. H. Ciocârlie

*Inference of Safe Approximate Models for System Composition*

**Andreea-Paula ROBU**

Supervisor prof. L. Stoicu-Tivadar

*Contribuții privind algoritmi și programele de modelare și simulare a evoluției sistemelor multicelulare în ingineria tisulară*

(Contributions Regarding the Algorithms and Programs for Modeling and Simulation of the Evolution of Multicellular Systems in Tissue Engineering)

**Mădălin GAVRILESCU**

Supervisor prof. I. Jian

*Cyber Physical System Applications Verification and Validation*

## Electrical Engineering

**Diana Paula PETRILA**

Supervisor prof. N. Muntean

*Energy Conversion and Storage Control for Small Wind Turbine Systems*

**Mihaela-Loredana GAVRIȘ**

Supervisor prof. N. Muntean

*Dual Input DC-DC Converters for Renewable Energy Processing*

**Raluca Oana Sonia ROB**

Supervisor prof. I. Șora

*Reducerea poluării electromagnetice la echipamente electrotermice de înaltă frecvență*

(Diminution of Electromagnetic Pollution at High Frequency Electrothermal Equipments)

## Civil Engineering

**Mihai Cristian VULCU**

Supervisor prof. D. Dubină

*Seismic Performance of Dual Steel Frames of CFRHS and Welded Beam-to-Column Joints*

**Cristian PĂCURAR**

Supervisor prof. A. Retezan

*Studiu privind randamentul activităților didactice în funcție de climatul ambiental*

(Study Regarding Efficiency of Didactic Activities Depending on Ambient Climate)

**Adrian Ciprian MAYER**

Supervisor prof. V. Haida

*Contribuții la studiul comportării în timp a terasamentelor de cale ferată*

(Contributions to the Behaviour in Time Study of Railway Beds)

**Hanelore MUNTEAN**

Supervisor prof. G. Crețu

*Cercetări asupra procesului de autoepurare în Bazinul Hidrografic Bega*

(Research on the Process of Self-Purification in the River Bega)

<b>Doru PELIVAN</b> Supervisor prof. I. Sârbu	<i>Optimizarea sistemelor de livrare a apei calde în centralele termice cu puterea nominală peste 100 KW</i> (Optimization of Hot Water Delivery Systems in Thermal Power Stations with Power Exceeding 100 KW)
<b>Anamaria Ioana BUTIȘCA</b> Supervisor prof. R. Băncilă	<i>Reabilitarea podurilor metalice istorice cu console și articulații (Gerber)</i> (Rehabilitation of Historical Steel Cantilever Bridges)
<b>Andreea Luiza ROMAN</b> Supervisor prof. V. Haida	<i>Contribuții la studiul folosirii materialelor geosintetice în lucrări de inginerie geotehnică</i> (Contributions Regarding the Use of Geosynthetics in Geotechnical Engineering)
<b>Cătălina Maria BOCAN</b> Supervisor prof. V. Stoian	<i>Reabilitarea durabilă a blocurilor de locuințe tipizate din panouri mari - supraetajare ușoară cu structură în cadre prefabricate din beton armat</i> (Sustainable Rehabilitation of Standardized Large Panel Housing Blocks - A Light Precast Reinforced Concrete Structural Frame Attic)
<b>Constanța ENE</b> Supervisor prof. G. Rogobete Supervisor prof. V. D. Ciobanu	<i>Managementul incendiilor forestiere în zona Moldova Nouă – Berzasca din sud – vestul României</i> (Forest Fire Management in the Area Moldova Nouă – Berzasca from South-West of Romania)
<b>Tudor MORAR</b> Supervisor prof. I. Costescu	<i>Accesibilitatea și mobilitatea pietonală în mediul urban</i> (Pedestrian Accessibility and Mobility in the Urban Environment)
<b>Călin SEBARCHIEVICI</b> Supervisor prof. I. Sârbu	<i>Optimizarea instalațiilor termice din clădiri în scopul reducerii consumului energetic și a emisiilor de CO2 utilizând pompa de căldură cuplată la sol</i> (Optimization of Buildings Thermal Systems to Reduce Energy Consumption and CO2 Emissions Using the Ground Coupled Heat Pump)

## Engineering and Management

<b>Alexandru-Ioan CÂNDA</b> Supervisor prof. A. Drăghici	<i>Întreprinderea agilă - Strategii manageriale și modele organizaționale</i> (Agile Enterprise Management Strategies and Organizational Models)
<b>Sabina Alina ȘERAN</b> Supervisor prof. M. Izvercian	<i>Contribuții privind conceptul de prosumator și strategii de marketing</i> (Contributions to the Prosumer Concept and Marketing Strategies)
<b>Victoria Larisa IVAȘCU</b> Supervisor prof. M. Izvercian	<i>Contribuții privind managementul riscului în întreprinderea sustenabilă</i> (Contributions on Risk Management in the Sustainable Enterprise)
<b>Cosmina Carmen ALDEA</b> Supervisor prof. A. Drăghici	<i>Contribuții privind managementul echipelor virtuale de proiect</i> (Contributions to the Virtual Teams Project Management)

## Systems Engineering

<b>Octavian ȘTEFAN</b> Supervisor prof. T. L. Dragomir	<i>Modelling, Analysis and Synthesis of Some Structures for Networked Control</i>
<b>Emanuel Ciprian SASU</b> Supervisor prof. O. Proștean	<i>Strategii de detecție a pătrunderilor neautorizate în sisteme informatice</i> (Strategies for Intrusion Detection in Computer Systems)
<b>Gelu- Laurențiu IOANAȘ</b> Supervisor prof. T. L. Dragomir	<i>Dezvoltarea unui model de predicție a presiunii în sistemele piezo common – rail diesel bazat pe rețele neuro-fuzzy cu modele dinamice linearizate local</i> (Developing a Pressure Prediction Model for Piezo Common-Rail Diesel Systems Based on Neuro-Fuzzy Networks with Local Linearized Models)

# Scientific Conferences and Events





## Scientific Conferences and Events held in 2013

### International Conference on Professional Communication and Translation Studies - 8th Edition

4-5 April 2013, Timisoara

**Organizer:** Department of Communication and Foreign Languages

<http://www.cls.upt.ro/files/conferinta/Conferinta%202013/Conference%20Flyer%202013.pdf>

### IEEE 8th International Symposium on Applied Computational Intelligence and Informatics (SACI 2013)

23-25 May 2013, Timisoara

**Organizer:** Department of Automation and Applied Informatics

<http://www.conf.uni-obuda.hu/saci2013/general.htm>

### The 12th International Symposium "Acoustics and Vibration of Mechanical Structures"

23-24 Mai 2013, Timișoara

**Organizer:** Faculty of Mechanical Engineering/ Chair of Mechanical Engineering and Vibration

<http://www.mec.upt.ro/meca/avms/>

### Symposium on "Sustainability of Construction: Effective Solutions for the Design, Construction and Rehabilitation of Buildings" Timisoara

24-25 Mai 2013, Timișoara

**Organizer:** Department of Civil Engineering and Equipments, RECO and AICPS-Timisoara Branches, within the 12th edition of "ACADEMIC DAYS of Timis County"

<http://www.ct.upt.ro/articole/articol240513.htm>

### Creation of nano structures via self-organisation and self-assembly and the application of nano structures to biomedical engineering (Conference held by Professor Toru MAEKAWA, director of Bio-Nano Electronics Research Centre, Tokyo University, Japan)

June 5, 2013, Timisoara

**Organizer:** Research Centre for Complex Fluid Systems Engineering and Department of Mechanical Machines, Equipment and Transportation

[http://avizier.upt.ro/wp-content/uploads/2013/05/Invitatie-Avizier\\_Maekawa.pdf](http://avizier.upt.ro/wp-content/uploads/2013/05/Invitatie-Avizier_Maekawa.pdf)

### International Conference on Advances in Environmental Science – "Join us for a Clean and Energy Secure Future. Tendencies & Solutions"

11-12 June 2013, Timisoara

**Organizer:** Research Centre for Thermal Machines, Transportation and Environmental Protection

<http://otem2013.mec-upt.ro/>

### The International Conference on Engineering Graphic and Design - ICEGD 2013

13-15 iunie 2013, Timișoara

**Organizers:** Faculties of Civil Engineering, Mechanical Engineering and Architecture

[http://www.ct.upt.ro/icegd2013/ICEGD\\_2013.pdf](http://www.ct.upt.ro/icegd2013/ICEGD_2013.pdf)

### SIM 2013: 12th International Symposium in Management

11-12 October 2013, Timisoara

**(Co) Organizer:** Faculty of Management in Production and Transportation

<http://www.sim2013.org/>

### „Advanced Materials and Structures AMS 2013” – 5th International Conference

24-25 October 2013, Timisoara

**Organizer:** Materials and Manufacturing Engineering Department and The Politehnica Foundation

<http://eng.upt.ro/imf/AMS%202013/Home.html>

## **International Conference on Applied Sciences**

26-27 octombrie 2013 Wuhan, China

**Organizer:** Politehnica University of Timisoara, Military Economics Academy of Wuhan

Starting with this year the conference will be held alternately in China and Romania. This year the venue is Wuhan, China.

<http://www.icoas2013.net/index.htm>

## **Sustainable Highways: Design, Construction, Maintenance**

30-31 October 2013, Timisoara

**Organizer:** Faculty of Civil Engineering, UPT, Professional Association of Roads and Bridges from Romania (A.P.D.P.) –the BANAT Branch and FAYAT Romania

<http://www.ct.upt.ro/articole/articol151113.htm>

# Scientific Journals



## Scientific Journals

**Academic Journal of Manufacturing and Engineering**, Tome 11, Issue 1, 2, 3, 4  
<http://eng.upt.ro/auif/journal.html>

**Annals of Faculty Engineering Hunedoara:**  
**International Journal of Engineering**, Tome 11, Issue 1, 2, 3, 4  
<http://annals.fih.upt.ro/issues.html>

**Journal of Electrical Engineering**, Tome 13, Issue 1, 2, 3, 4  
<http://www.jee.ro/index.php>

**Transaction on Automatic Control and Computer Science**, Tome 58 (72), Issue 1  
<http://www.ac.upt.ro/journal/>

**Transaction on Hydrotehnics**, Tome 58(72), Issue 1, Special Issue  
<http://www.ct.upt.ro/buletinhidro/index.htm>

**Transaction on Mathematics and Physics**, Tome 58 (72), Issue 1, 2  
[http://www.upt.ro/cercetare/mate\\_fizica.php](http://www.upt.ro/cercetare/mate_fizica.php)

**Transaction on Modern Languages**, Tome 12, Issue 1-2  
<http://www.cceol.com/asp/issuedetails.aspx?issueid=82f5f4a5-29ab-4684-afca-ec1ae43a270e>

**Transaction on Physical Education and Sport**, Tome 11, Issue 1-2  
[http://www.efs.upt.ro/buletin\\_stiintific.php](http://www.efs.upt.ro/buletin_stiintific.php)

**Acta Technica Corviniensis - Bulletin of Engineering**, Tome 6, Issue 1, 2, 3, 4  
<http://acta.fih.upt.ro/issues.html>





# ISI Publications



## ISI Publications

1. Agarlita, S. C.; Coman, C. E.; Andreescu, G. D.; Boldea, I., Stable V/f control system with controlled power factor angle for permanent magnet synchronous motor drives, IET ELECTRIC POWER APPLICATIONS, 2013
2. Agarlita, S. C.; Tutelea, L. N.; Boldea, I., Modelling and control of a springless resonant linear permanent magnet oscillator, IET ELECTRIC POWER APPLICATIONS, 2013
3. Albulescu, C. T., FINANCIAL STABILITY AND MONETARY POLICY: A REDUCED-FORM MODEL FOR THE EURO AREA, ROMANIAN JOURNAL OF ECONOMIC FORECASTING, 2013
4. Alexa, V., ISSUES FOR MONITORING THE POLLUTANTS IN WASTEWATERS AND THE ENVIRONMENTAL MANAGEMENT SYSTEM IN METALLURGY, JOURNAL OF ENVIRONMENTAL PROTECTION AND ECOLOGY, 2013
5. Andronache, C.; Socalici, A.; Heput, T., THE INFLUENCE OF MICRO COOLERS ON THE PHYSICAL-MECHANICAL CHARACTERISTICS OF THE STEELS USED IN MAKING RAILWAY MONOBLOCK WHEELS, TEHNICKI VJESNIK-TECHNICAL GAZETTE, 2013
6. Ariesanu, C. P., Stability Problems for Chua System with One Linear Control, JOURNAL OF APPLIED MATHEMATICS, 2013
7. Artene, A. E.; Domil, A. E., EMPIRICAL STUDY REGARDING THE INFLUENCE OF FISCAL REVENUES OVER R&D ACTIVITY DEVELOPMENT, METALURGIA INTERNATIONAL, 2013
8. Babuta, R.; Lazau, I.; Pacurariu, C., Study of CaO center dot 2Al(2)O(3) formation by polymeric precursor method, JOURNAL OF THERMAL ANALYSIS AND CALORIMETRY, 2013
9. Balogh, R. M.; Ionel, I.; Stepan, D., ENVIRONMENTAL EXHAUST OF THE FLUE GASES ORIGINATED FROM THE DIESEL HYDRAULIC ENGINE LOCOMOTIVE 1250 HP, JOURNAL OF ENVIRONMENTAL PROTECTION AND ECOLOGY, 2013
10. Balta, H.; Douillard, C., On the Influence of the Extrinsic Information Scaling Coefficient on the Performance of Single and Double Binary Turbo Codes, ADVANCES IN ELECTRICAL AND COMPUTER ENGINEERING, 2013
11. Balta, H.; Douillard, C.; Lucaciu, R., Multi-non-binary turbo codes, EURASIP Journal on Wireless Communications and Networking, 2013
12. Barbu, M.; Stoia, M.; Barvinschi, P.; Barbu-Tudoran, L.; Stefanescu, M., Study on the formation of MCr2O4/SiO2 nanocomposites from hybrid gels PVA-TEOS-metal nitrates, THERMOCHIMICA ACTA, 2013
13. Barvinschi, P.; Barbu, M.; Stoia, M.; Stefanescu, M., Evaluation of cation influence on the formation of M(II)Cr2O4 during the thermal decomposition of mixed carboxylate type precursors, JOURNAL OF THERMAL ANALYSIS AND CALORIMETRY, 2013
14. Barvinschi, P.; Stefanescu, O.; Dippong, T.; Sorescu, S.; Stefanescu, M., CoFe2O4/SiO2 nanocomposites by thermal decomposition of some complex combinations embedded in hybrid silica gels, JOURNAL OF THERMAL ANALYSIS AND CALORIMETRY, 2013
15. Belega, D., Accuracy analysis of the normalized frequency estimation of a discrete-time sine-wave by the average-based interpolated DFT method, MEASUREMENT, 2013
16. Belega, D.; Petri, D., Accuracy Analysis of the Multicycle Synchronphasor Estimator Provided by the Interpolated DFT Algorithm, IEEE TRANSACTIONS ON INSTRUMENTATION AND MEASUREMENT, 2013
17. Belega, D.; Petri, D., Statistical Performance of the Effective-Number-of-Bit Estimators Provided by the Sine-Fitting Algorithms, IEEE TRANSACTIONS ON INSTRUMENTATION AND MEASUREMENT, 2013
18. Binzar, T.; Lazureanu, C., A RIKITAKE TYPE SYSTEM WITH ONE CONTROL, DISCRETE AND CONTINUOUS DYNAMICAL SYSTEMS-SERIES B, 2013
19. Binzar, T.; Lazureanu, C., On some dynamical and geometrical properties of the Maxwell-Bloch equations with a quadratic control, JOURNAL OF GEOMETRY AND PHYSICS, 2013

20. Birsan, M.; Sadowski, T.; Marsavina, L.; Linul, E.; Pietras, D., Mechanical behavior of sandwich composite beams made of foams and functionally graded materials, *INTERNATIONAL JOURNAL OF SOLIDS AND STRUCTURES*, 2013
21. Bistran, D. A., Mathematical and numerical treatment of instabilities of non-axisymmetric confined vortices under the Dirichlet boundary conditions, *APPLIED MATHEMATICAL MODELLING*, 2013
22. Bistran, D.A., Parabolized Navier-Stokes model for study the interaction between roughness structures and concentrated vortices, *PHYSICS OF FLUIDS*, 2013
23. Blaga, L.; Bancila, R.; dos Santos, J. F.; Amancio, S.T., Friction Riveting of glass-fibre-reinforced polyetherimide composite and titanium grade 2 hybrid joints, *MATERIALS & DESIGN*, 2013
24. Bobina, M.; Kellenberger, A.; Millet, J. P.; Muntean, C.; Vaszilcsin, N., Corrosion resistance of carbon steel in weak acid solutions in the presence of L-histidine as corrosion inhibitor, *CORROSION SCIENCE*, 2013
25. Bobina, M.; Vaszilcsin, N.; Muntean, C., Influence of Tryptophan on the Corrosion Process of Carbon Steel in Aqueous Weak Acid Solutions, *REVISTA DE CHIMIE*, 2013
26. Boboescu, I. Z.; Gherman, V. D.; Mirel, I.; Maroti, G.; Negrea, A.; Ciopec, M.; Motoc, M., Development of a Two-step Fermentative Biohydrogen Production Process Using Selectively Enriched Microbial Populations as Inoculum, *REVISTA DE CHIMIE*, 2013
27. Bokinala, K. K.; Pollet, M.; Artemenko, A.; Miclau, M.; Grozescu, I., Synthesis of lithium cobalt oxide by single-step soft hydrothermal method, *JOURNAL OF SOLID STATE CHEMISTRY*, 2013
28. Bokinala, K.; Miclau, M., A preliminary study on the hydrothermal synthesis of layered cobalt oxides, *OPTOELECTRONICS AND ADVANCED MATERIALS-RAPID COMMUNICATIONS*, 2013
29. Bolos, O. C.; Bortun, C. M.; Cernescu, A.; Ardelean, L.; Bolos, A.; Rusu, L.C., Fracture Toughness Evaluation of Some Resins Used in Complete Dentures Technology, *MATERIALE PLASTICE*, 2013
30. Boran, S.; Tamas, A., RHEOLOGICAL BEHAVIOR OF SOME OILS ADDITIVATED WITH MIXED PYROMELLITIC ESTERS, *STUDIA UNIVERSITATIS BABES-BOLYAI CHEMIA*, 2013
31. Borcanescu, S.; Lazau, I.; Lazau, R. I.; Pacurariu, C., MALAYAITE PINK PIGMENTS BEHAVIOR IN COLOURING SOME TABLEWARE FAIENCE GLAZES, *REVISTA ROMANA DE MATERIALE-ROMANIAN JOURNAL OF MATERIALS*, 2013
32. Brabec, M.; Badescu, V.; Paulescu, M., Nowcasting sunshine number using logistic modeling, *METEOROLOGY AND ATMOSPHERIC PHYSICS*, 2013
33. Buchman, I.; Dencsak, T., TECHNICAL AND ECONOMIC ASPECTS OF SPECIAL INDUSTRIAL CONCRETE, *REVISTA ROMANA DE MATERIALE-ROMANIAN JOURNAL OF MATERIALS*, 2013
34. Buzdugan, D.; Codrean, C.; Serban, V. A.; Cornea, F., Corrosion behaviour of bulk Fe<sub>67</sub>Cr<sub>4</sub>Mo<sub>4</sub>Ga<sub>4</sub>P<sub>12</sub>B<sub>5</sub>C<sub>4</sub> amorphous alloy and its crystallized form, *JOURNAL OF OPTOELECTRONICS AND ADVANCED MATERIALS*, 2013
35. Calinoiu D.; Paulescu M.; Ionel I.; Stefu N.; Pop N.; Boata R.; Pacurar A.; Gravila P.; Paulescu E.; Trif-Tordai G., Influence of aerosols pollution on the amount of collectable solar energy, *ENERGY CONVERSION AND MANAGEMENT*, 2013
36. Calinoiu, D.; Ionel, I.; Trif-Tordai, G., Analysis of optical properties of aerosols by means of photometry, *OPTOELECTRONICS AND ADVANCED MATERIALS-RAPID COMMUNICATION*, 2013
37. Carabet, A.; Florescu, C.; Staniloiu, C.; Podoleanu, C.; Visescu, M.; Belu, M.; Ilie, C., The Efficiency of Resita Town Water Treatment Plant, *REVISTA DE CHIMIE*, 2013
38. Caruntu, B.; Bota, C., Approximate polynomial solutions of the nonlinear Lane-Emden type equations arising in astrophysics using the squared remainder minimization method, *COMPUTER PHYSICS COMMUNICATIONS*, 2013
39. Cernaianu, M. O.; Gontean, A., High-accuracy thermoelectrical module model for energy-harvesting systems, *IET CIRCUITS DEVICES & SYSTEMS*, 2013

40. Cernaianu, M. O.; Gontean, A., Parasitic elements modelling in thermoelectric modules, IET CIRCUITS DEVICES & SYSTEMS, 2013
41. Cernazanu-Glavan, C.; Holban, S., Segmentation of Bone Structure in X-ray Images using Convolutional Neural Network, ADVANCES IN ELECTRICAL AND COMPUTER ENGINEERING, 2013
42. Cernescu, A.; Dumitru, I.; Faur, N.; Branzei, N.; Bogdan, R., The analysis of a damaged component from the connection system of the wagons, ENGINEERING FAILURE ANALYSIS, 2013
43. Chakrabarti, K.; Backodissa-Kiminou, D. R.; Pop, N.; Mezei, J. Z.; Motapon, O.; Lique, F.; Dulieu, O.; Wolf, A.; Schneider, I. F., Dissociative recombination of electrons with diatomic molecular cations above dissociation threshold: Application to H-2(+) and HD+, PHYSICAL REVIEW A, 2013
44. Cioabla, A. E.; Ionel, I.; Tenchea, A.; Dumitrel, G. A.; Pode, V., Solid Biofuel Database – Potential of using Vegetal Biomass in Biogas Production, REVISTA DE CHIMIE, 2013
45. Cioabla, A. E.; Ionel, I.; Trif-Tordai, G.; Irimescu, A.; Vetres, I., STUDY ON THE QUALITY OF BIOGAS OBTAINED FROM AGRICULTURAL RESIDUES DURING ANAEROBIC FERMENTATION, JOURNAL OF ENVIRONMENTAL PROTECTION AND ECOLOGY, 2013
46. Ciobanu, C.; Lazau, I.; Pacurariu, C., Investigation of the cellulose ethers effect on the Portland cement hydration by thermal analysis, JOURNAL OF THERMAL ANALYSIS AND CALORIMETRY, 2013
47. Ciobanu, C.; Lazau, I.; Pacurariu, C., Investigation regarding the effect of viscosity modifying admixtures upon the Portland cement hydration using thermal analysis, JOURNAL OF THERMAL ANALYSIS AND CALORIMETRY, 2013
48. Ciopec, M.; Davidescu, C. M.; Negrea, A.; Lupa, L.; Popa, A.; Muntean, C.; Ardelean, R.; Ilia, G., Synthesis, characterization, and adsorption behavior of aminophosphinic grafted on poly(styrene-Co-divinylbenzene) for divalent metal ions in aqueous solutions, POLYMER ENGINEERING AND SCIENCE, 2013
49. Cirstea, C.; Petrita, T.; Popescu, V.; Gontean, A., Performance Analysis and Modelling of a Radio Frequency Energy Harvesting System, ADVANCES IN ELECTRICAL AND COMPUTER ENGINEERING, 2013
50. Ciubotariu, R. C.; Secosan, E. R.; Serban, V. A.; Frunzaverde, D., MICROSTRUCTURAL CHARACTERIZATION OF SELF-FLUXING ALLOY COATINGS BEFORE AND AFTER FLAME REMELTING, METALURGIA INTERNATIONAL, 2013
51. Codrean, C.; Stoian, C.; Serban, V. A.; Opris, C. STAINLESS STEELS BRAZING WITH NICKEL AND COPPER BASED AMORPHOUS ALLOYS, METALURGIA INTERNATIONAL, 2013
52. Cornea, F. M.; Codrean, C.; Melcioiu, G.; Tosa, D. I., NON-CONVENTIONAL TECHNOLOGY FOR PROCESSING SPECIMENS OF AMORPHOUS ALLOYS IN RIBBONS FORM USED ON TENSILE TEST, METALURGIA INTERNATIONAL, 2013
53. Creanga, I.; Fagadar-Cosma, G.; Palade, A.; Lascu, A.; Enache, C.; Birdeanu, M.; Fagadar-Cosma, E., NEW HYBRID SILVER COLLOID-A(3)B PORPHYRIN COMPLEX EXHIBITING WIDE BAND ABSORPTION, DIGEST JOURNAL OF NANOMATERIALS AND BIOSTRUCTURES, 2013
54. Crisan, E.; Vilceanu, L.; Ardelean, M.; Putan, V., RESEARCH REGARDING THE COMPRESSION BEHAVIOUR OF FERROUS BRIQUETTES, TEHNICKI VJESNIK-TECHNICAL GAZETTE, 2013
55. Cristea, M.; Groza, B., Fingerprinting Smartphones Remotely via ICMP Timestamps, IEEE COMMUNICATIONS LETTERS, 2013
56. David, R. C.; Precup, R. E.; Petriu, E. M.; Radac, M. B.; Preitl, S., Gravitational search algorithm-based design of fuzzy control systems with a reduced parametric sensitivity, INFORMATION SCIENCES, 2013
57. Davidescu, C. M.; Ciopec, M.; Negrea, A.; Popa, A.; Lupa, L.; Dragan, E. S.; Ardelean, R.; Ilia, G.; Iliescu, S., Synthesis, characterization, and Ni(II) ion sorption properties of poly(styrene-co-divinylbenzene) functionalized with aminophosphonic acid groups, POLYMER BULLETIN, 2013
58. Dobra, R. M., CORROSION BEHAVIOUR IN 0.5M H2SO4 OF DUPLEX TREATED EN 16 MnCr5, METALURGIA INTERNATIONAL, 2013

59. Dobra, R. M.; Mitelea, I.; Bobina, M., CORROSION BEHAVIOUR OF DUPLEX TREATMENT BASED ON GAS CARBURIZING AND SURFACE INDUCTION QUENCHING, METALURGIA INTERNATIONAL, 2013
60. Domil, A. E.; Artene, A. E.; Bunget, O. C., THE IMPORTANCE OF ENVIRONMENTAL ACCOUNTING INFORMATION FOR THE ROMANIAN INNOVATIVE ENTITIES, METALURGIA INTERNATIONAL, 2013
61. Dordea, T.; Proca, V.; Madescu, G.; Torac, I.; Biriescu, M.; Mot, M.; Ocolisan, L., COMPUTATION AND MEASUREMENT OF STRAND CURRENTS IN A FULL-SCALE MULTISTRAND CONDUCTOR, PROCEEDINGS OF THE ROMANIAN ACADEMY SERIES A-MATHEMATICS PHYSICS TECHNICAL SCIENCES INFORMATION SCIENCE, 2013
62. Draganescu, G. E., Interaction between the Kravchuck and Meixner oscillators coherent states and the coherent radiation field, PHYSICA SCRIPTA, 2013
63. Dragos, C. A.; Precup, R. E.; Tomescu, M. L.; Preitl, S.; Petriu, E. M.; Radac, M. B., An Approach to Fuzzy Modeling of Electromagnetic Actuated Clutch Systems, INTERNATIONAL JOURNAL OF COMPUTERS COMMUNICATIONS & CONTROL, 2013
64. Dubina, D.; Ungureanu, V.; Crisan, A., Experimental Evidence of Erosion of Critical Load in Interactive Buckling, JOURNAL OF STRUCTURAL ENGINEERING-ASCE, 2013
65. Dumitru, I.; Marsavina, L.; Faur, N.; Kun, L., Some considerations on the mechanical testing of aluminum-steel conductors and their cores, MECHANIKA, 2013
66. Dumitru, R.; Papa, F.; Balint, I.; Culita, D. C.; Munteanu, C.; Stanica, N.; Ianculescu, A.; Diamandescu, L.; Carp, O., Mesoporous cobalt ferrite: A rival of platinum catalyst in methane combustion reaction, APPLIED CATALYSIS A-GENERAL, 2013
67. Ermalai, I.; Dragulescu, B.; Ternauciu, A.; Vasiu, R., Building a Module for Inserting Microformats into Moodle, ADVANCES IN ELECTRICAL AND COMPUTER ENGINEERING, 2013
68. Faur, C.; Crainic, N.; Sticlaru, C.; Oancea, C., Rapid prototyping technique in the preoperative planning for total hip arthroplasty with custom femoral components, WIENER KLINISCHE WOCHENSCHRIFT, 2013
69. Fenchea, M., Design of hammer mills for optimum performance, JOURNAL OF VIBRATION AND CONTROL, 2013
70. Gabor, R.; dos Santos, J. F., FRICTION STIR WELDING DEVELOPMENT OF ALUMINIUM ALLOYS FOR STRUCTURAL CONNECTIONS, PROCEEDINGS OF THE ROMANIAN ACADEMY SERIES A-MATHEMATICS PHYSICS TECHNICAL SCIENCES INFORMATION SCIENCE, 2013
71. Gallien, B.; Sylla, L.; Bengulescu, M.; Barvinschi, F.; Duffar, T., Study of crystal-crucible detachment: GaSb in SiO<sub>2</sub>, CRYSTENG-COMM, 2013
72. Gavris, G.; Stoaia, M.; Petrehele, A. I. G.; Fodor, A., Sodium Hypophosphite as Reduction Reagent for Cooper Ions Recovery from Aqueous Solutions, REVISTA DE CHIMIE, 2013
73. Gavruta, P., ON THE FEICHTINGER CONJECTURE, ELECTRONIC JOURNAL OF LINEAR ALGEBRA, 2013
74. Geanta, V.; Voiculescu, I.; Stefanoiu, R.; Binchiciu, H.; Negriu, R. M.; Tat, P.I., RESEARCHES REGARDING THE ESTABLISHMENT OF THE OPTIMAL CHEMICAL COMPOSITION OF THE CENTRIFUGAL CRUSHERS RETENTION SILLS, METALURGIA INTERNATIONAL, 2013
75. Georgescu, M.; Ungureanu, V., CONVERSION OF AN EXISTING STEEL INDUSTRIAL HALL WITH CRANE INTO A MULTI-STOREY OFFICE BUILDING, JOURNAL OF ENVIRONMENTAL PROTECTION AND ECOLOGY, 2013
76. Gheju, M.; Stelescu, I., Chelant-assisted phytoextraction and accumulation of Zn by Zea mays, JOURNAL OF ENVIRONMENTAL MANAGEMENT, 2013
77. Grecea, C.; Bala, A. C.; Herban, S., CADASTRAL REQUIREMENTS FOR URBAN ADMINISTRATION, KEY COMPONENT FOR AN EFFICIENT TOWN PLANNING, JOURNAL OF ENVIRONMENTAL PROTECTION AND ECOLOGY, 2013
78. Groza, B.; Murvai, S., Efficient Protocols for Secure Broadcast in Controller Area Networks, IEEE TRANSACTIONS ON INDUSTRIAL INFORMATICS, 2013

79. Guccione, M.; Jivulescu, M. A. ; Messina, A., Unitary decoupling treatment of a quadratic bimodal cavity quantum electro-dynamics model, *PHYSICA SCRIPTA*, 2013
80. Hadaruga, N. G.; Hadaruga, D. I.; Isengard, H. D., "Surface water" and "strong-bonded water" in cyclodextrins: a Karl Fischer titration approach, *JOURNAL OF INCLUSION PHENOMENA AND MACROCYCLIC CHEMISTRY*, 2013
81. Hatiegan, C.; Raduca, M.; Frunzaverde, D.; Raduca, E.; Pop, N.; Gillich, GR, The modeling and simulation of the thermal analysis on the hydrogenerator stator winding insulation, *JOURNAL OF THERMAL ANALYSIS AND CALORIMETRY*, Volume: 113 Issue: 3 Pages: 1217-1221
82. Hedrea, C.; Golet, I.; Negrea, R., GEOMETRIC PREQUANTIZATION OF THE DUAL A LIE ALGEBRA, *INTERNATIONAL JOURNAL OF GEOMETRIC METHODS IN MODERN PHYSICS*, 2013
83. Hiticas, I.; Marin, D.; Mihon, L., MODELLING AND OPERATIONAL TESTING OF PULSE-WIDTH MODULATION AT INJECTION TIME FOR A SPARK-IGNITION ENGINE, *TEHNICKI VJESNIK-TECHNICAL GAZETTE*, 2013
84. Hristodor, C. M.; Vrinceanu, N.; Pode, R.; Copcia, V. E.; Botezatu, E.; Popovici, E., Preparation and thermal stability of Al<sub>2</sub>O<sub>3</sub>-clay and Fe<sub>2</sub>O<sub>3</sub>-clay nanocomposites, with potential application as remediation of radioactive effluents, *JOURNAL OF THERMAL ANALYSIS AND CALORIMETRY*, 2013
85. Ianos, R.; Lazau, R.; Babuta, R.; Borcanescu, S.; Boruntea, C. R., Nanocrystalline BaAl<sub>2</sub>O<sub>4</sub> powders prepared by aqueous combustion synthesis, *CERAMICS INTERNATIONAL*, 2013
86. Iliescu, D.; Sarbescu, P., The relationship of dangerous driving with traffic offenses: A study on an adapted measure of dangerous driving, *ACCIDENT ANALYSIS AND PREVENTION*, 2013
87. Ilinoiu, E. C.; Manea, F.; Serra, P. A.; Pode, R., Simultaneous/Selective Detection of Dopamine and Ascorbic Acid at Synthetic Zeolite-Modified/Graphite-Epoxy Composite Macro/Quasi-Microelectrodes, *SENSORS*, 2013
88. Ilinoiu, E. C.; Pode, R.; Manea, F.; Colar, L. A.; Jakab, A.; Orha, C.; Ratiu, C.; Lazau, C.; Sfarloaga, P., Photocatalytic activity of a nitrogen-doped TiO<sub>2</sub> modified zeolite in the degradation of Reactive Yellow 125 azo dye, *JOURNAL OF THE TAIWAN INSTITUTE OF CHEMICAL ENGINEERS*, 2013
89. Ionel, R. C., IDENTIFICATION-BASED TDOA ESTIMATION, *JOURNAL OF ENVIRONMENTAL PROTECTION AND ECOLOGY*, 2013
90. Ionel, R. C.; Ionel, S.; Ignea, A., Calculation of the Second Order Settling Time in SISO Linear Systems, *CIRCUITS SYSTEMS AND SIGNAL PROCESSING*, 2013
91. Isar, A.; Isar, D., Analog Frequency Tracking Filter, *ADVANCES IN ELECTRICAL AND COMPUTER ENGINEERING*, 2013
92. Jafarzadeh, S.; Lascu, C.; Fadali, M. S., Square Root Unscented Kalman Filters for State Estimation of Induction Motor Drives, *IEEE TRANSACTIONS ON INDUSTRY APPLICATIONS*, 2013
93. Jakab, A.; Manea, F.; Bandas, C.; Remes, A.; Pop, A.; Pode, R.; Schoonman, J., UNMODIFIED/TiO<sub>2</sub>-MODIFIED CARBON NANOTUBES COMPOSITE ELECTRODES FOR PENTACHLOROPHENOL DETECTION FROM WATER, *ENVIRONMENTAL ENGINEERING AND MANAGEMENT JOURNAL*, 2013
94. Jitian, S., THE ELLIPSOMETRICAL STUDY OF ADSORPTION-DESORPTION OF THE CORROSION INHIBITORS ON METALLIC SURFACES, *ROMANIAN REPORTS IN PHYSICS*, 2013
95. Jiva, C.; Jebeleanu, E.; Borza, I., THE DEVELOPING IN TIME OF CERTAIN DEGRADATIONS IN THE EXISTING CONCRETE BRIDGES, *METALURGIA INTERNATIONAL*, 2013
96. Kampouris, A.; Anastasiadis, A.; Mosoarca, M., ENVIRONMENTAL IMPACT ASSESSMENT AND EVALUATION OF ROAD CONSTRUCTION WORKS IN FOREST ECOSYSTEMS, *JOURNAL OF ENVIRONMENTAL PROTECTION AND ECOLOGY*, 2013
97. Kellenberger, A.; Plesu, N.; Mihali Tara-Lunga, M.; Vaszilcsin, N., Synthesis of polyaniline nanostructures by electrochemical deposition on niobium, *POLYMER*, 2013
98. Kim, K.; Radu, A. G. ; Wang, X. Q.; Mignolet, M. P., Nonlinear reduced order modeling of isotropic and functionally graded plates, *INTERNATIONAL JOURNAL OF NON-LINEAR MECHANICS*, 2013



99. Lascu, M., A New Method for Calculating the Transfer Functions in Quasiresonant Converters, *ADVANCES IN ELECTRICAL AND COMPUTER ENGINEERING*, 2013
100. Lazar, I. C., A connection between 5-systolicity and CAT(-1) metrics on cubical complexes, *BALKAN JOURNAL OF GEOMETRY AND ITS APPLICATIONS*, 2013
101. Lazar, I. C., Systolic simplicial complexes are collapsible, *BULLETIN MATHÉMATIQUE DE LA SOCIÉTÉ DES SCIENCES MATHÉMATIQUES DE ROUMANIE*, 2013
102. Lazau, I.; Borcanescu, S.; Pacurariu, C.; Vancea, C., Kinetic study of the non-isothermal crystallization process of hematite in ceramic glazes obtained from CRT wastes, *JOURNAL OF THERMAL ANALYSIS AND CALORIMETRY*, 2013
103. Lazau, I.; Corcoveanu, C.; Pacurariu, C.; Lazau, R.I., NiAl<sub>2</sub>O<sub>4</sub> PREPARED BY COMBUSTION SYNTHESIS, *REVISTA ROMANA DE MATERIALE-ROMANIAN JOURNAL OF MATERIALS*, 2013
104. Lazau, I.; Vancea, C.; Mosoarca, G., NEW VITREOUS MATRIX FOR THE LEAD WASTES IMMOBILIZATION, *REVISTA ROMANA DE MATERIALE-ROMANIAN JOURNAL OF MATERIALS*, 2013
105. Lazureanu, C.; Binarz, T., Symplectic realizations and symmetries of a Lotka-Volterra type system, *REGULAR & CHAOTIC DYNAMICS*, 2013
106. Lemle, L. D.; Wang, R.; Wu, L. M., Uniqueness of Fokker-Planck equations for spin lattice systems (I): compact case, *SEMI-GROUP FORUM*, 2013
107. Lonea, A. M.; Popescu, D. E.; Tianfield, H., Detecting DDoS Attacks in Cloud Computing Environment, *INTERNATIONAL JOURNAL OF COMPUTERS COMMUNICATIONS & CONTROL*, 2013
108. Lupa, L.; Negrea, A.; Ciopec, M.; Negrea, P., Cs<sup>+</sup> Removal from Aqueous Solutions through Adsorption onto Florisil (R) Impregnated with Trihexyl(tetradecyl)phosphonium Chloride, *MOLECULES*, 2013
109. Magureanu, G.; Gavrilescu, M.; Pescaru, D., Validation of static properties in unified modeling language models for cyber physical systems, *JOURNAL OF ZHEJIANG UNIVERSITY-SCIENCE C-COMPUTERS & ELECTRONICS*, 2013
110. Makra, L.; Ionel, I.; Csepe Z.; Matyasovszky I.; Lontis N.; Popescu F.; Sumeghy Z.; The effect of different transport modes on urban PM<sub>10</sub> levels in two European cities, *SCIENCE OF THE TOTAL ENVIRONMENT*, 2013
111. Manzana, M. E.; Ghiban, B.; Ghiban, N.; Bordeasu, I., ASPECTS OF CAVITATION EROSION BEHAVIOUR OF DIFFERENT STEELS, *METALURGIA INTERNATIONAL*, 2013
112. Marc, P.; Costescu, I., INDUSTRIAL WASTES USED IN PAVEMENT LAYERS, *JOURNAL OF ENVIRONMENTAL PROTECTION AND ECOLOGY*, 2013
113. Marian, E.; Jurca, T.; Duteanu, N., Comparative Study of Metals in *Hypericum Perforatum*, *Hypericum Maculatum* and *Hypericum Tea* by Microwave Digestion-ICP-OES, *REVISTA DE CHIMIE*, 2013
114. Marinca, V.; Herisanu, N., Optimal Variational Method for Truly Nonlinear Oscillators, *JOURNAL OF APPLIED MATHEMATICS*, 2013
115. Marsavina, L.; Linul, E.; Voiconi, T.; Sadowski, T., A comparison between dynamic and static fracture toughness of polyurethane foams, *POLYMER TESTING*, 2013
116. Marsavina, L.; Sadowski, T.; Kneć, M., Crack propagation paths in four point bend Aluminium-PMMA specimens, *ENGINEERING FRACTURE MECHANICS*, 2013
117. Melcioiu, G.; Codrean, C.; Cornea, F. M.; Tosa, D. I., THE ANALYSIS OF WHISKERS GROWTH FROM STRUCTURAL AND STATISTICAL POINT OF VIEW, *METALURGIA INTERNATIONAL*, 2013
118. Miclaus, S.; Bechet, P.; Iftode, C., The application of a channel-individualized method for assessing long-term, realistic exposure to radiofrequency radiation emitted by mobile communication base station antennas, *MEASUREMENT*, 2013
119. Mihaela, O., Study about the possibility to control the superparamagnetism-superferromagnetism transition in magnetic nanoparticle systems, *JOURNAL OF MAGNETISM AND MAGNETIC MATERIALS*, 2013

120. Mihoc, G.; Ianos, R.; Pacurariu, C.; Lazau, I., Combustion synthesis of some iron oxides used as adsorbents for phenol and p-chlorophenol removal from wastewater, JOURNAL OF THERMAL ANALYSIS AND CALORIMETRY, 2013
121. Milicevic, D.; Katic, V.; Corba, Z.; Greconici, M., New Space Vector Selection Scheme for VSI Supplied Dual Three-Phase Induction Machine, ADVANCES IN ELECTRICAL AND COMPUTER ENGINEERING, 2013
122. Mirea, M.; Voicu, C. O., FOUNDATION SOLUTION WITH LOW IMPACT ON THE ENVIRONMENT, JOURNAL OF ENVIRONMENTAL PROTECTION AND ECOLOGY, 2013
123. Mitelea, I.; Budau, V.; Dorohoi, C.; Craciunescu, C. M., Experiments on the advantages and limits of using conventional friction welding for joining dissimilar and graded materials, SURFACE ENGINEERING AND APPLIED ELECTROCHEMISTRY, 2013
124. Mitelea, I.; Groza, C.; Craciunescu, C., Copper Interlayer Contribution on Nd:YAG Laser Welding of Dissimilar Ti-6Al-4V Alloy with X5CrNi18-10 Steel, JOURNAL OF MATERIALS ENGINEERING AND PERFORMANCE, 2013
125. Moisa, I. G. ; Susan-Resiga, R.; Muntean, S., PUMP INDUCER OPTIMIZATION BASED ON CAVITATION CRITERION, PROCEEDINGS OF THE ROMANIAN ACADEMY SERIES A-MATHEMATICS PHYSICS TECHNICAL SCIENCES INFORMATION SCIENCE, 2013
126. Mosoarca, M. ; Gioncu, V., Historical wooden churches from Banat Region, Romania. Damages: Modern consolidation solutions, JOURNAL OF CULTURAL HERITAGE, 2013
127. Mosoarca, M.; Gioncu, V., Failure mechanisms for historical religious buildings in Romanian seismic areas, JOURNAL OF CULTURAL HERITAGE, 2013
128. Mosoarca, M.; Victor, G., Structural safety of historical buildings made of reinforced concrete, from Banat region Romania, JOURNAL OF CULTURAL HERITAGE, 2013
129. Motoc, S.; Manea, F.; Pop, A.; Baciuc, A.; Burtica, G.; Pode, R., ELECTROCHEMICAL MINERALIZATION OF REACTIVE RED 147 DYE ON BORON-DOPED DIAMOND ELECTRODES, ENVIRONMENTAL ENGINEERING AND MANAGEMENT JOURNAL, 2013
130. Muntean, C.; Stoia, M.; Barvinschi, P., SYNTHESIS OF NANOCRYSTALLINE ZnFe<sub>2</sub>O<sub>4</sub> AND ITS USE FOR THE REMOVAL OF CONGO RED FROM AQUEOUS SOLUTIONS, ENVIRONMENTAL ENGINEERING AND MANAGEMENT JOURNAL, 2013
131. Muntean, S. G.; Paska, O.; Coseri, S.; Simu, G. M.; Grad, M E.; Ilia, G., Evaluation of a functionalized copolymer as adsorbent on direct dyes removal process: Kinetics and equilibrium studies, JOURNAL OF APPLIED POLYMER SCIENCE, 2013
132. Neamt, I.; Ionel, I., ENVIRONMENTAL MANAGEMENT OF THE SEWAGE SLUDGE: CASE STUDY - THE WASTEWATER TREATMENT PLANT OF TIMISOARA, TEHNICKI VJESNIK-TECHNICAL GAZETTE, 2013
133. Negoitescu, A.; Tokar, A., INVESTIGATIONS ON CAR EMISSIONS UNDER THE URBAN TRAFFIC CONDITIONS WITH THE INFLUENCE ON TIMISOARA AIR QUALITY, TRANSPORT, 2013
134. Negrea, A.; Ciopec, M.; Davidescu, C M.; Muntean, C.; Negrea, P.; Lupa, L., KINETIC, EQUILIBRIUM AND THERMODYNAMIC STUDIES OF CESIUM REMOVAL FROM AQUEOUS SOLUTIONS USING AMBERJET UP1400 AND AMBERLITE IR120 RESINS, ENVIRONMENTAL ENGINEERING AND MANAGEMENT JOURNAL, 2013
135. Negrea, A.; Muntean, C.; Botnarescu, I.; Ciopec, M.; Motoc, M., Effect of Matrix Solution on As(V) Adsorption onto Iron-containing Materials pH and kinetic studies, REVISTA DE CHIMIE, 2013
136. Negrea, A.; Lupa, L.; Lazau, R.; Ciopec, M.; Pop, O.; Motoc, M., Adsorption Properties of Fe<sub>2</sub>O<sub>3</sub> and Fe<sub>2</sub>O<sub>3</sub>:SiO<sub>2</sub> Mixtures in the Removal Process of As(III) from Underground Waters, REVISTA DE CHIMIE, 2013
137. Negru, R.; Marsavina, L.; Filipescu, H.; Pasca, N., Investigation of Mixed Mode I/II Brittle Fracture Using ASCB Specimen, INTERNATIONAL JOURNAL OF FRACTURE, 2013
138. Niculescu, M.; Dumitru, R.; Magda, A.; Pode, V., New Methods to Obtain Carboxylic Acids by Oxidation Reactions of Polyols with Metal(II) Nitrates II. Oxidation reactions of 1,3-propanediol with metal(II) nitrates, REVISTA DE CHIMIE, 2013
139. Novaconi, S.; Vaszilcsin, N., Inductive heating hydrothermal synthesis of titanium dioxide nanostructures, MATERIALS LETTERS, 2013
140. Orlescu, C. M. ; Costescu, I. A., SOLID WASTE MANAGEMENT IN ROMANIA: CURRENT AND FUTURE ISSUES, ENVIRONMENTAL ENGINEERING AND MANAGEMENT JOURNAL, 2013

141. Owe, E.; Vignoles, V. L.; Becker, M.; Brown, R.; Smith, P. B.; Lee, S. W. S.; Easterbrook, M.; Gadre, T.; Zhang, X.; Gheorghiu, M.; Baguma, P.; Tatarko, A.; Aldhafri, S.; Zinkeng, M.; Schwartz, S. J.; Des Rosiers, S. E.; Villamar, J. A.; Mekonnen, K. H.; Regalia, C.; Manzi, C.; Brambilla, M.; Kusdil, E.; Caglar, S.; Gavreliuc, A.; Martin, M.; Zhang, J. X.; Lv, S. B.; Fischer, R.; Milfont, T. L.; Torres, A.; Camino, L.; Kreuzbauer, R.; Gausel, N.; Buitendach, J. H.; Lemos, F. C. S.; Fritsche, I.; Moller, B.; Harb, C.; Valk, A.; Espinosa, A.; Jaafar, J. L.; Yuki, M.; Ferreira, M. C.; Chobthamkit, P.; Fulop, M.; Chybicka, A.; Wang, Q.; Bond, M. H.; Gonzalez, R.; Didier, N.; Carrasco, D.; Cadena, M. P.; Lay, S.; Garoarsdotir, R. B.; Nizharadze, G.; Pyszczynski, T.; Kesebir, P.; Herman, G.; de Sauvage, I.; Courtois, M.; Bourguignon, D.; Ozgen, E.; Guner, U. E.; Yamakoglu, N.; Abuhamedh, S.; Mogaji, A.; Macapagal, M. E. J.; Koller, S. H.; Amponsah, B.; Misra, G.; Kapur, P.; Trujillo, E. V.; Balanta, P.; Ayala, B. C.; Gallo, I. S.; Gil, P. P.; Clemares, R. L.; Campara, G.; Jalal, B., Contextualism as an Important Facet of Individualism-Collectivism: Personhood Beliefs Across 37 National Groups, *JOURNAL OF CROSS-CULTURAL PSYCHOLOGY*, 2013
142. Pacurar, A.; Stefu, N.; Mares, O.; Paulescu, E.; Calinoiu, D.; Pop, N.; Boata, R.; Gravila, P.; Paulescu, M., Forecasting hourly global solar irradiation using simple non-seasonal models, *JOURNAL OF RENEWABLE AND SUSTAINABLE ENERGY*, 2013
143. Pacurariu, C.; Mihoc, G.; Popa, A.; Muntean, S. G.; Ianos, R., Adsorption of phenol and p-chlorophenol from aqueous solutions on poly (styrene-co-divinylbenzene) functionalized materials, *CHEMICAL ENGINEERING JOURNAL*, 2013
144. Palade, A. C.; Pillon, G. P.; Cicala, E.; Grevey, D.; Marsavina, L., Subsurface treatment of a contact subjected to a hertz pressure, *INTERNATIONAL JOURNAL OF MECHANICAL SCIENCES*, 2013
145. Palade, A.; Fagadar-Cosma, G.; Lascu, A.; Creanga, I.; Birdeanu, M.; Fagadar-Cosma, E., NEW PORPHYRIN -BASED SPECTROPHOTOMETRIC SENSOR FOR Ag-0 DETECTION, *DIGEST JOURNAL OF NANOMATERIALS AND BIOSTRUCTURES*, 2013
146. Parvulescu, V.; Niculescu, V.; Ene, R.; Popa, A.; Mureseanu, M.; Ene, C. D.; Andruh, M., Supported monocationic copper(II) complexes obtained by coordination with dialkylphosphonate groups on styrene-divinylbenzene copolymer as catalysts for oxidation of organic compounds, *JOURNAL OF MOLECULAR CATALYSIS A-CHEMICAL*, 2013
147. Pascu, L. V.; Putan, A.; Socalici, A.; Heput, T., RESEARCHES ON THE QUALITY OF PIG IRON TO BE USED IN MAKING RAIL BRAKING SHOES, *METALURGIA INTERNATIONAL*, 2013
148. Pater, F. L., NOTE ON KATO'S TYPE INEQUALITY, *MATHEMATICAL INEQUALITIES & APPLICATIONS*, 2013
149. Pernevan, M. S.; Marsavina, L.; Radu, D.; Popa, M.; Sirghie, C., Considerations About the Impact Behavior of Biocomposites Based on Polypropylene and Furan Resins Reinforced With Hemp Shives, *JOURNAL OF NATURAL FIBERS*, 2013
150. Petric, M.; Crisan, L.; Crisan, M.; Micle, A.; Maranescu, B.; Ilia, G., Synthesis and QSRR Study for a Series of Phosphoramidic Acid Derivatives *HETEROATOM CHEMISTRY 2*
151. Petrisor, E., Twist number and order properties of periodic orbits, *PHYSICA D-NONLINEAR PHENOMENA*, 2013
152. Plesu, N.; Kellenberger, A.; Taranu, I.; Taranu, B. O.; Popa, I., Impedimetric detection of dopamine on poly(3-aminophenylboronic acid) modified skeleton nickel electrodes, *REACTIVE & FUNCTIONAL POLYMERS*, 2013
153. Pop, N.; Mogos, A. M.; Vlase, G.; Vlase, T.; Doca, N., Theoretic analysis and experimental evidence for relationships between the derivative thermogravimetric curves and the Gramm-Schmidt profiles, *JOURNAL OF THERMAL ANALYSIS AND CALORIMETRY*, 2013
154. Pop, N.; Popov, D.; Davidovic, M., Density Operator in Terms of Coherent States Representation with the Applications in the Quantum Information, *INTERNATIONAL JOURNAL OF THEORETICAL PHYSICS*, 2013
155. Pop, R.; Medeleanu, M.; Diudea, M. V.; Szeffler, B.; Cioslowski, J., Fullerenes patched by flowers, *CENTRAL EUROPEAN JOURNAL OF CHEMISTRY*, 2013
156. Popa, G. N.; Dinis, C. M.; Deaconu, S. I., Considerations on the Current Harmonics of Plate-Type Electrostatic Precipitators Power Supplies, *ELEKTRONIKA IR ELEKTROTEHNIKA*, 2013
157. Popa, M.; Glevitzky, M.; Dumitrel, G. A., MICROBIOLOGICAL RISK ASSESSMENT OF ICE-CREAM PRODUCTS, *JOURNAL OF ENVIRONMENTAL PROTECTION AND ECOLOGY*, 2013
158. Pop-Calimanu, M.; Amarteifio, N.; Fleser, T., A study on the effect of FSW parameters on mechanical and microstructural properties of AA2124/SiC/25%p-T4 metal composite; *Metalurgia International*, ISSN 1582-2214, Editura Stintifica F.M.R, Bucuresti, Romania, vol. 18, Nr. 8 (2013), 155-160, ISI

159. Popov, Dusan; Dong, Shi-Hai; Pop, Nicolina; Simon, Simona, Construction of the Barut-Girardello quasi coherent states for the Morse potential, ANNALS OF PHYSICS Volume: 339 Pages: 122-134 Published: DEC 2013
160. Popov, D.; Pop, N.; Davidovic, M., Negative binomial states for the pseudoharmonic oscillator, PHYSICA SCRIPTA, 2013
161. Popov, D.; Sajfert, V.; Pop, N.; Chiritoiu, V., About a new family of coherent states for some SU(1,1) central field potentials, JOURNAL OF MATHEMATICAL PHYSICS, 2013
162. Prada, M. F.; Brata, S.; Tudor, D. F.; Popescu, D. E., REDUCING OF GAS EMISSIONS ACCORDING TO THE EU ENERGY POLICY TARGETS, JOURNAL OF ENVIRONMENTAL PROTECTION AND ECOLOGY, 2013
163. Precup, R. E.; David, R. C.; Petriu, E. M.; Preitl, S.; Radac, M. B., EXPERIMENTS IN FUZZY CONTROLLER TUNING BASED ON AN ADAPTIVE GRAVITATIONAL SEARCH ALGORITHM, PROCEEDINGS OF THE ROMANIAN ACADEMY SERIES A-MATHEMATICS PHYSICS TECHNICAL SCIENCES INFORMATION SCIENCE, 2013
164. Precup, R. E.; David, R. C.; Petriu, E. M.; Preitl, S.; Radac, M. B., Fuzzy logic-based adaptive gravitational search algorithm for optimal tuning of fuzzy-controlled servo systems, IET CONTROL THEORY AND APPLICATIONS, 2013
165. Precup, R. E.; David, R. C.; Petriu, E. M.; Radac, M. B.; Preitl, S.; Fodor, J., Evolutionary optimization-based tuning of low-cost fuzzy controllers for servo systems, KNOWLEDGE-BASED SYSTEMS, 2013
166. Precup, R. E.; Radac, M. B.; Tomescu, M. L.; Petriu, E. M.; Preitl, S., Stable and convergent iterative feedback tuning of fuzzy controllers for discrete-time SISO systems, EXPERT SYSTEMS WITH APPLICATIONS, 2013
167. Precup, R. E.; Tomescu, M. L.; Preitl, S.; Petriu, E. M.; Fodor, J.; Pozna, C., Stability analysis and design of a class of MIMO fuzzy control systems, JOURNAL OF INTELLIGENT & FUZZY SYSTEMS, 2013
168. Putan, A.; Putan, V.; Heput, T.; Socalici, A., Steel treatment with calcium-aluminate synthetic slag and addition of titanium oxide, REVISTA DE METALURGIA, 2013
169. Radac, M. B.; Precup, R. E.; Petriu, E. M.; Preitl, S., Experiment-based Performance Improvement of State Feedback Control Systems for Single Input Processes, ACTA POLYTECHNICA HUNGARICA, 2013
170. Radac, M. B.; Precup, R. E.; Petriu, E. M.; Preitl, S.; Dragos, C. A., Data-Driven Reference Trajectory Tracking Algorithm and Experimental Validation, IEEE TRANSACTIONS ON INDUSTRIAL INFORMATICS, 2013
171. Radoslav, R.; Branea, A. M.; Gaman, M. S., Rehabilitation through a holistic revitalization strategy of historical city centres Timisoara, Romania, JOURNAL OF CULTURAL HERITAGE, 2013
172. Rafaila, M.; Medeleanu, M.; Davidescu, C. M., Nucleophilicity Evaluation for Primary and Secondary Amines, REVISTA DE CHIMIE, 2013
173. Rafaila, M.; Medeleanu, M.; Davidescu, C.; Diudea, M. V., LAPLACIAN AND MODIFIED LAPLACIAN MATRICES FOR QUANTIFICATION OF CHEMICAL STRUCTURES, STUDIA UNIVERSITATIS BABES-BOLYAI CHEMIA, 2013
174. Rafaila, M.; Pascariu, M. C.; Gruia, A.; Penescu, M.; Purcarea, V. L.; Medeleanu, M.; Rusnac, L. M.; Davidescu, C. M., GC-MS ANALYSIS OF LONG CHAIN MANNOFURANOSE DERIVATIVES AS BIOCOMPATIBLE SURFACTANT PRECURSORS. CORRELATION BETWEEN PEAK INTENSITIES AND STABILITY OF CORRESPONDING FRAGMENTS, FARMACIA, 2013
175. Rosu, R. A.; Serban, V. A.; Bucur, A. I.; Popescu, M., CHARACTERIZATION OF YTTRIA AND MAGNESIA PARTIALLY STABILIZED ZIRCONIA BIOCOMPATIBLE COATINGS DEPOSITED BY PLASMA SPRAYING, CERAMICS-SILIKATY, 2013
176. Serban, D. A.; Weber, G.; Marsavina, L.; Silberschmidt, V. V.; Hufenbach, W., Tensile properties of semi-crystalline thermoplastic polymers: Effects of temperature and strain rates, POLYMER TESTING, 2013
177. Serban, V. A.; Buzdugan, D.; Codrean, C.; Ercuta, A., Preparation and characterization of Fe<sub>67</sub>Cr<sub>4</sub>Mo<sub>4</sub>Ga<sub>4</sub>P<sub>12</sub>B<sub>5</sub>C<sub>4</sub> ferromagnetic bulk amorphous alloy, JOURNAL OF OPTOELECTRONICS AND ADVANCED MATERIALS, 2013
178. Serban, V. A.; Hulka, I.; Utu, D.; Vuoristo, P.; Niemi, K., WEAR AND CORROSION BEHAVIOUR OF HVOF AND HVOF DEPOSITED Cr<sub>3</sub>C<sub>2</sub>-NiCr COATINGS, METALURGIA INTERNATIONAL, 2013
179. Serban, V. A.; Rosu, R. A.; Bucur, A. I.; Pascu, D. R., Deposition of titanium nitride layers by electric arc - Reactive plasma spraying method, APPLIED SURFACE SCIENCE, 2013
180. Slavici, T.; Almajan, B., ARTIFICIAL INTELLIGENCE TECHNIQUES: AN EFFICIENT NEW APPROACH TO CHALLENGE THE ASSESSMENT OF COMPLEX CLINICAL FIELDS SUCH AS AIRWAY CLEARANCE TECHNIQUES IN PATIENTS WITH CYSTIC FIBROSIS?, JOURNAL OF REHABILITATION MEDICINE, 2013

181. Socoliuc, V.; Vekas, L.; Turcu, R., Magnetically induced phase condensation in an aqueous dispersion of magnetic nanogels, *SOFT MATTER*, 2013
182. Sofronia, R. E.; Knott, T.; Davidescu, A.; Savii, G. G.; Kuhlen, T.; Gerressen, M., Failure mode and effects analysis in designing a virtual reality-based training simulator for bilateral sagittal split osteotomy, *INTERNATIONAL JOURNAL OF MEDICAL ROBOTICS AND COMPUTER ASSISTED SURGERY*, 2013
183. Staniloiu, C.; Florescu, C.; Popescu, V., Current Trends in the Use of Small Wastewater Treatment Plant, *REVISTA DE CHIMIE*, 2013
184. Stefan, L. M.; Pana, A. M.; Bandur, G.; Martin, P.; Popa, M.; Rusnac, L. M., Thermal analysis of new glycopolymers derived from monosaccharides, *JOURNAL OF THERMAL ANALYSIS AND CALORIMETRY*, 2013
185. Stefanescu, C.; David, I.; Visescu, M., TECHNICAL SOLUTION FOR LOW IMPACT STORM WATER MANAGEMENT IN THE URBAN AREA, *JOURNAL OF ENVIRONMENTAL PROTECTION AND ECOLOGY*, 2013
186. Stefanescu, O.; Stefanescu, M., New Fe(III) malonate type complex combination for development of magnetic nanosized gamma-Fe<sub>2</sub>O<sub>3</sub>, *JOURNAL OF ORGANOMETALLIC CHEMISTRY*, 2013
187. Stefanescu, O.; Vlase, G.; Barbu, M.; Barvinschi, P.; Stefanescu, M., Preparation of CuFe<sub>2</sub>O<sub>4</sub>/SiO<sub>2</sub> nanocomposite starting from Cu(II)-Fe(III) carboxylates embedded in hybrid silica gels, *JOURNAL OF THERMAL ANALYSIS AND CALORIMETRY*, 2013
188. Stefanescu, O.; Vlase, T.; Sorescu, S.; Barvinschi, P.; Stefanescu, M., Thermal behavior of Co(II) and Ni(II) hydroxycarboxylate complexes obtained by two original synthesis methods, *JOURNAL OF THERMAL ANALYSIS AND CALORIMETRY*, 2013
189. Stoia, M.; Barvinschi, P.; Barbu-Tudoran, L., Thermal decomposition of metal nitrates PVA-TEOS gels for obtaining M(II) ferrite/silica nanocomposites, *JOURNAL OF THERMAL ANALYSIS AND CALORIMETRY*, 2013
190. Stoia, M.; Barvinschi, P.; Barbu-Tudoran, L.; Negrea, A.; Barvinschi, F., Influence of thermal treatment on the formation of zirconia nanostructured powder by thermal decomposition of different precursors, *JOURNAL OF CRYSTAL GROWTH*, 2013
191. Stoia, M.; Tudoran, L. B.; Barvinschi, P., Nanosized zinc and magnesium ferrites obtained from PVA-metal nitrates' solutions, *JOURNAL OF THERMAL ANALYSIS AND CALORIMETRY*, 2013
192. Stolojescu-Crisan, C.; Isar, A., Forecasting WiMAX traffic by data mining methodology *EURASIP Journal on Wireless Communications and Networking*, 2013
193. Stolojescu-Crisan, C.; Isar, A.; Moga, S.; Lenca, P., WiMAX traffic analysis and base stations classification in terms of LRD, *EXPERT SYSTEMS*, 2013
194. Tamasila, M.; Pugna, A. P.; Taucean, I. M., AN ENHANCED MODEL TO STUDY ENTREPRENEURIAL INTENTION IN HIGHER EDUCATION, *METALURGIA INTERNATIONAL*, 2013
195. Tanasa, C.; Susan-Resiga, R.; Muntean, S.; Bosioc, Al., Flow-Feedback Method for Mitigating the Vortex Rope in Decelerated Swirling Flows, *JOURNAL OF FLUIDS ENGINEERING-TRANSACTIONS OF THE ASME*, 2013
196. Thalmaier, G.; Codrean, C.; Sechel, N.; Vida-Simiti, I., CRYSTALLIZATION KINETICS OF AMORPHOUS V47Ni32Ti21 ALLOY, *METALURGIA INTERNATIONAL*, 2013
197. Thalmaier, G.; Vida-Simiti, I.; Vermesan, H.; Codrean, C.; Chira, M., Amorphous Ni<sub>36</sub>Zr<sub>35</sub>Ti<sub>29</sub> alloy as bipolar plates for polymer electrolyte membrane fuel cells, *OPTOELECTRONICS AND ADVANCED MATERIALS-RAPID COMMUNICATIONS*, 2013
198. Tiwari, A. K.; Mutascu, M. I.; Albulescu, C. T., The influence of the international oil prices on the real effective exchange rate in Romania in a wavelet transform framework, *ENERGY ECONOMICS*, 2013
199. Topac, V.; Stoicu-Tivadar, V., Patient Empowerment by Increasing the Understanding of Medical Language for Lay Users, *METHODS OF INFORMATION IN MEDICINE*, 2013
200. Ungurean, M.; Paul, C.; Peter, F., Cellulase immobilized by sol-gel entrapment for efficient hydrolysis of cellulose, *BIOPROCESS AND BIOSYSTEMS ENGINEERING*, 2013
201. Ungureanu, V.; Georgescu, M., REFURBISHMENT OF A MULTI-STOREY WELDED STEEL STRUCTURE LOCATED IN A SEISMIC AREA, *JOURNAL OF ENVIRONMENTAL PROTECTION AND ECOLOGY*, 2013
202. Utu, I. D.; Hulka, I.; Serban, V. A., Microstructure and Abrasion Wear Resistance of Thermally Sprayed Cermet Coatings, *MATERIALS TESTING*, 2013

203. Valea, E. S.; Sarbu, I., ACTIONS TO REDUCE AIR POLLUTION FROM A COAL THERMAL POWER PLANT, ENVIRONMENTAL ENGINEERING AND MANAGEMENT JOURNAL, 2013
204. Vartolomei, M., THE MANAGEMENT OF CONVERGENCE PLAY OPTIMISATION, METALURGIA INTERNATIONAL, 2013
205. Vlascici, D.; Popa, I.; Chiriac, V.; Fagadar-Cosma, G.; Popovici, H.; Fagadar-Cosma, E., Potentiometric detection and removal of copper using porphyrins, CHEMISTRY CENTRAL JOURNAL, 2013
206. Volosencu, C.; Curiac, D. I., Efficiency improvement in multi-sensor wireless network based estimation algorithms for distributed parameter systems with application at the heat transfer, EURASIP JOURNAL ON ADVANCES IN SIGNAL PROCESSING, 2013
207. Wachter, M. R.; Ionel, I.; Negrea, A., NEW CONCEPT FOR LANDFILL DISPOSAL OF MUNICIPAL SOLID WASTE INCINERATION RESIDUES, JOURNAL OF ENVIRONMENTAL PROTECTION AND ECOLOGY, 2013
208. Xiao, X. C.; Zhu, Y. C.; Gavruta, L., Some Properties of K-Frames in Hilbert Spaces, RESULTS IN MATHEMATICS, 2013
209. Zaharia, R.; Vulcu, C.; Vassart, O.; Gernay, T.; Franssen, J. M., Numerical analysis of partially fire protected composite slabs, STEEL AND COMPOSITE STRUCTURES, 2013





# ISI Proceedings



## ISI Proceedings

1. Adam, A.; Prostean, G., Models for Sharing Resources in Agile Project Management, SOFT COMPUTING APPLICATIONS, 2013
2. Alexa, F.; Bardeanu, B.; Vatau, D., MIMO Antenna System for LTE, 36th International Conference on Telecommunications and Signal Processing (TSP), JUL 02-04, 2013, Rome, Italy, IEEE, NEW YORK, 978-1-4799-0402-0; 978-1-4799-0403-7, 2013
3. Amarandei, M.; Berdich, K.; Szigyarto, I.; Kun, L.; Marsavina, L., Nondestructive Evaluation of Polyurethane Materials Using Transient Thermography, ADVANCES IN FRACTURE AND DAMAGE MECHANICS XI, 2013
4. Ana-Andreea, M.; Liviu, N. M.; Alina, M. C., Factors of influence in the choice of a higher education specialization in Romania, 3RD WORLD CONFERENCE ON PSYCHOLOGY, COUNSELING AND GUIDANCE, WCPCG-2012, 2013
5. Babeti, S., Spinning Black Holes in a Gauge Theory of Gravitation, TIM 2012 PHYSICS CONFERENCE, 2013
6. Baloi, A.; Molnar-Matei, F., A Fuzzy Approach for Power Quality Standards, UKSIM-AMSS 15TH INTERNATIONAL CONFERENCE ON COMPUTER MODELLING AND SIMULATION (UKSIM 2013), 2013
7. Baloi, A.; Pana, A., Software Solutions for Harmonic Conditions Monitoring and Optimal Placing of Reactive Power Sources in Distributions Networks, INTERDISCIPLINARY RESEARCH IN ENGINEERING: STEPS TOWARDS BREAKTHROUGH INNOVATION FOR SUSTAINABLE DEVELOPMENT, 2013
8. Balta, H.; Balta, M., 8 states triple binary convolutional encoders for the construction of turbo codes, INTERDISCIPLINARY RESEARCH IN ENGINEERING: STEPS TOWARDS BREAKTHROUGH INNOVATION FOR SUSTAINABLE DEVELOPMENT, 2013
9. Balta, H.; Lucaciu, R.; Mihaescu, A., 32 States Double Binary Turbo Code, 36th International Conference on Telecommunications and Signal Processing (TSP), JUL 02-04, 2013, Rome, Italy, IEEE, NEW YORK, 978-1-4799-0402-0; 978-1-4799-0403-7, 2013
10. Berdie, A. D.; Osaci, M.; Budisan, N., A Multicriteria Approach in the Selection of a SAP UI Technology, SOFT COMPUTING APPLICATIONS, 2013
11. Bernad, S. I.; Bosioc, A.; Totorean, A.; Stanciu, R.; Bernad, E. S., Vortices in By-pass Graft Flow, 11TH INTERNATIONAL CONFERENCE OF NUMERICAL ANALYSIS AND APPLIED MATHEMATICS 2013, PTS 1 AND 2 (ICNAAM 2013), 2013
12. Bernad, S. I.; Totorean, A.; Bosioc, A.; Stanciu, R.; Bernad, E. S., Numerical Investigation of Dean Vortices in a Curved Pipe, 11TH INTERNATIONAL CONFERENCE OF NUMERICAL ANALYSIS AND APPLIED MATHEMATICS 2013, PTS 1 AND 2 (ICNAAM 2013), 2013
13. Bitea, M. A.; Dolga, V., Object detection with ultrasound sensors in mobile robots working area, MEASUREMENT TECHNOLOGY AND ITS APPLICATION, PTS 1 AND 2, 2013
14. Bogdan, L.; Nes, C. S.; Faur, N.; Amarandei, M.; Enkelhardt, A., Numerical analysis of femoral neck angle influence on stress distribution of cemented Austin Moore hip prosthesis, ADVANCES IN FRACTURE AND DAMAGE MECHANICS XI, 2013
15. Boraci, R.; Vasar, C., Experimental Application of a Pragmatic Method to Design Control Strategy for Low Power Wind Energy Conversion System, SOFT COMPUTING APPLICATIONS, 2013
16. Briciu, C. V.; Filip, I.; Heining, F., A new trend in automotive software: AUTOSAR concept, 2013 IEEE 8TH INTERNATIONAL SYMPOSIUM ON APPLIED COMPUTATIONAL INTELLIGENCE AND INFORMATICS (SACI 2013), 2013
17. Cirstea, C.; Davidescu, R.; Gontean, A., A Reinforcement Learning Strategy for Task Scheduling of WSNs with Mobile Nodes, 36th International Conference on Telecommunications and Signal Processing (TSP), JUL 02-04, 2013, Rome, Italy, IEEE, NEW YORK, 978-1-4799-0402-0; 978-1-4799-0403-7, 2013

18. Cirstea, C.; Davidescu, R.; Jianu, A., Optimum Communication Paths for Mobile WSNs using Genetic Algorithms, 36th International Conference on Telecommunications and Signal Processing (TSP), JUL 02-04, 2013, Rome, Italy, IEEE, NEW YORK, 978-1-4799-0402-0; 978-1-4799-0403-7, 2013
19. Cirstea, C.; Prostean, O.; Cirstea, C., DOAF - A Development Framework for Distributed Applications, 36th International Conference on Telecommunications and Signal Processing (TSP), JUL 02-04, 2013, Rome, Italy, IEEE, NEW YORK, 978-1-4799-0402-0; 978-1-4799-0403-7, 2013
20. Cirstea, C.; Prostean, O.; Cirstea, C., DOAF - Replica Localization Module, 36th International Conference on Telecommunications and Signal Processing (TSP), JUL 02-04, 2013, Rome, Italy, IEEE, NEW YORK, 978-1-4799-0402-0; 978-1-4799-0403-7, 2013
21. Ciugudean, M. A.; Balas, M. M., CMOS-Integrated Temperature Relay Based on Widlar Mirror, SOFT COMPUTING APPLICATIONS, 2013
22. Cozma, M.; Dejica-Cartis, D., A psychological approach to professional translator education, 3RD WORLD CONFERENCE ON PSYCHOLOGY, COUNSELING AND GUIDANCE, WCPCG-2012, 2013
23. Cristian, D.; Barbulescu, C.; Kilyeni, S.; Pop, O.; Solomonesc, F., Artificial intelligence based TNEP. Part 1: Mathematical models, Proceedings of the 8th IEEE International Symposium on Applied Computational Intelligence and Informatics (SACI), May 23-25, 2013, Timisoara, Romania, pp. 391-394, ISBN 978-146736400-3, 2013
24. Cristian, D.; Barbulescu, C.; Kilyeni, S.; Popescu, V.; Particle swarm optimization techniques. Power systems applications, Proceedings of the 6th International Conference on Human System Interactions (HSI), June 6-8, 2013, Gdansk, Poland, pp. 312-319, ISBN 978-146735637-4, 2013
25. Cristian, D.; Simo, A.; Barbulescu, C.; Kilyeni, S., PSO Based Transmission Network Expansion, Proceedings of the 48th International Universities' Power Engineering Conference (UPEC), September 2-5, 2013, Dublin, Ireland, pp. 1-6, ISBN 978-1-4799-3254-2, 2013
26. Daneti, M., On Using Double Power Spectral Density Information for Leak Detection, 2013 IEEE INTERNATIONAL CONFERENCE ON INDUSTRIAL TECHNOLOGY (ICIT), 2013
27. Dejica-Cartis, A.; Dejica-Cartis, D., Tentative suggestions regarding the development of foreign language oral communication skills in students at universities of applied sciences, 3RD WORLD CONFERENCE ON PSYCHOLOGY, COUNSELING AND GUIDANCE, WCPCG-2012, 2013
28. Dejica-Cartis, D.; Cozma, M., Using Theme-Rheme analysis for improving coherence and cohesion in target-texts: a methodological approach, 3RD WORLD CONFERENCE ON PSYCHOLOGY, COUNSELING AND GUIDANCE, WCPCG-2012, 2013
29. Dragu, D.; Gomoj, V.; Stoicu-Tivadar, V., Achieving Semantic Integration of Medical Knowledge for Clinical Decision Support Systems, SOFT COMPUTING APPLICATIONS, 2013
30. Ermalai, I. L., IT gaining ground in Learning, INTERDISCIPLINARY RESEARCH IN ENGINEERING: STEPS TOWARDS BREAKTHROUGH INNOVATION FOR SUSTAINABLE DEVELOPMENT, 2013
31. Fedorovici, L. O.; Precup, R. E.; Dragan, F.; Purcaru, C., Evolutionary Optimization-Based Training of Convolutional Neural Networks for OCR Applications, 2013 17TH INTERNATIONAL CONFERENCE ON SYSTEM THEORY, CONTROL AND COMPUTING (ICSTCC), 2013
32. Fernandes, F. M. B.; Mahesh, K. K.; Craciunescu, C. M.; Oliveira, J. P.; Schell, N.; Miranda, R. M.; Quintino, L.; Ocana, J. L., In situ structural characterization of laser welded NiTi shape memory alloys, EUROPEAN SYMPOSIUM ON MARTENSITIC TRANSFORMATIONS, 2013
33. Gana, O.; Prostean, O.; Babescu, M., Maximization of the Energy and Flattening of Fluctuations for the Power Generated into the Network at a Wind Driven Electro Energetic System, SOFT COMPUTING APPLICATIONS, 2013

35. Georgiana, S.; Căleanu, C. D., Sparse Feature for Hand Gesture Recognition: A Comparative Study, 36th International Conference on Telecommunications and Signal Processing (TSP), JUL 02-04, 2013, Rome, Italy, IEEE, NEW YORK, 978-1-4799-0402-0; 978-1-4799-0403-7, 2013
36. Girban, G.; Popa, M., A Brief Outline of Computational Limitations on Actual Wireless Sensor Networks, SOFT COMPUTING APPLICATIONS, 2013
37. Holotescu, C.; Cismariu, L.; Spina, M. F.; Grosseck, G.; Naaji, A.; Dragomir, M., Identifying and Preventing Educators' Burnout Using a Microblogging Community, 3RD WORLD CONFERENCE ON PSYCHOLOGY, COUNSELING AND GUIDANCE, WCPCG-2012, 2013
38. Holotescu, C.; Grosseck, G.; Cretu, V., Mooc's Anatomy: Microblogging As The Mooc's Control Center, QUALITY AND EFFICIENCY IN E-LEARNING, VOL 2, 2013
39. Irimescu, A., Convective heat transfer equation for turbulent flow in tubes applied to internal combustion engines operated under motored conditions, APPLIED THERMAL ENGINEERING, 2013
40. Izvercian, M.; Ivascu, L.; Miclea, S., The Implications of Systemic Approach to Enterprise: Modeling, Simulation, Optimization, and Control of the System in Term of Risk, SOCIAL SCIENCES AND SOCIETY, 2013
41. Izvercian, M.; Seran, S. A., The Web 2.0 and the globalization impact on new consumer emergence and classification, PROCEEDINGS OF THE 2013 INTERNATIONAL CONFERENCE ON EDUCATION, MANAGEMENT AND SOCIAL SCIENCE (ICEMSS-13), 2013
42. Izvercianu, M.; Radu, A., Adaptation of Three Models of Human Resource Management Marketing to Increase Competitiveness, SOCIAL SCIENCES AND SOCIETY, 2013
43. Jafarzadeh, S.; Lascu, C.; Fadali, M. S., Square Root Unscented Kalman Filters for State Estimation of Induction Motor Drives, IEEE TRANSACTIONS ON INDUSTRY APPLICATIONS, 2013
44. Koch-Ciobotaru, C., Model Predictive Control for Inside Temperature of an Energy Efficient Building, SOFT COMPUTING APPLICATIONS, 2013
45. Lampa, I.; Greculescu, A.; Todorescu, L. L., Education for Sustainable Development - Training the Young Generation for the Future, PSIWORLD 2012, 2013
46. Lascutoni, A.; Ardelean, E. D.; Pascu, V. L.; Heput, T., Mathematical Model Regarding at Addition of Microcoolers in Tundish of Continuous Casting Machines, 11TH INTERNATIONAL CONFERENCE OF NUMERICAL ANALYSIS AND APPLIED MATHEMATICS 2013, PTS 1 AND 2 (ICNAAM 2013), 2013
47. Lascutoni, A.; Ardelean, E.; Socalici, A.; Ardelean, M., Mathematical Modeling of Micro-coolers Added in the Continuous Casting Tundish, 11TH INTERNATIONAL CONFERENCE OF NUMERICAL ANALYSIS AND APPLIED MATHEMATICS 2013, PTS 1 AND 2 (ICNAAM 2013), 2013
48. Linul, E.; Marsavina, L.; Voiconi, T.; Sadowski, T., Study of factors influencing the mechanical properties of polyurethane foams under dynamic compression, INTERNATIONAL SYMPOSIUM ON DYNAMIC DEFORMATION AND FRACTURE OF ADVANCED MATERIALS (D2FAM 2013), 2013
49. Liviu, N. M.; Ana-Andreea, M., Issues on Improving Internships in Technical Universities in Romania, 3RD WORLD CONFERENCE ON PSYCHOLOGY, COUNSELING AND GUIDANCE, WCPCG-2012, 2013
50. Lonea, A. M., Private Cloud Set Up Using Eucalyptus Open Source, SOFT COMPUTING APPLICATIONS, 2013
51. Lonea, A. M.; Popescu, D. E.; Prostean, O.; Tianfield, H., Evaluation of Experiments on Detecting Distributed Denial of Service (DDoS) Attacks in Eucalyptus Private Cloud, SOFT COMPUTING APPLICATIONS, 2013
52. Luminosu, I.; De Sabata, A., Feasibility of a Solar Swimming Pool in the Western Part of Romania, 2013 IEEE 8TH INTERNATIONAL SYMPOSIUM ON APPLIED COMPUTATIONAL INTELLIGENCE AND INFORMATICS (SACI 2013), 2013

54. Mateas, M. C.; Argesan, V.; Mateas, I., Considerations about thermal stress level evaluation methods, FOURTH INTERNATIONAL CONFERENCE PSYCHO-SOCIAL PERSPECTIVES IN THE QUASI-COERCIVE TREATMENT OF OFFENDERS: SOCIAL CONTROL AND VULNERABLE GROUPS (SPECTO 2013), 2013
55. Matiu-lovan, L.; Frigura-Iliasa, F. M.; Rancov, S., A Cubic B-Spline Interpolation Algorithm that Uses the First Derivative Values of the Input Function in the Knots, 36th International Conference on Telecommunications and Signal Processing (TSP), JUL 02-04, 2013, Rome, Italy, IEEE, NEW YORK, 978-1-4799-0402-0; 978-1-4799-0403-7, 2013
56. Mazilescu, C. A.; Mihartescu, A. A.; Pop, M. C.; Aldea, C., Gender relations in virtual project team, 3RD WORLD CONFERENCE ON PSYCHOLOGY, COUNSELING AND GUIDANCE, WCPCG-2012, 2013
57. Mihancea, P. F.; Marinescu, C., Changes, Defects and Polymorphism: is there any Correlation?, PROCEEDINGS OF THE 17TH EUROPEAN CONFERENCE ON SOFTWARE MAINTENANCE AND REENGINEERING (CSMR 2013), 2013
58. Mihet-Popa, L.; Bindner, H., Simulation models developed for voltage control in a distribution network using energy storage systems for PV penetration, in Proc. of the 39th Annual Conference of the IEEE Industrial Electronics Society-IECON'13, November 10-13, Vienna, Austria, pp. 7487-7492, ISSN: 1553-572X, ISBN: 978-1-4799-0224-8, Accession number: WOS: 000331149507049, 2013
59. Mihet-Popa, L.; Han, X.; Bindner, H.; Phil-Andersen, J.; Mehmedalic, J., Development and Modeling of different scenarios for a Smart Distribution Grid, in Proc. of the 8th International Symposium on Applied Computational Intelligence and Informatics-IEEE SACI 2013, Timisoara-Romania, May 23-25, pp. 257-261, ISBN: 978-1-4673-6400-3, WOS:000333188100079, 2013
60. Mihet-Popa, L.; Han, X.; Bindner, H.; Phil-Andersen, J.; Mehmedalic, J., Grid Modeling, Analysis and Simulation of different scenarios for a Smart Low-Voltage Distribution Grid, in Proc. of IEEE PES-ISGT Europe 2013, Lyngby, Denmark, October 6-9, ISSN: 2165-4816, ISBN: 978-1-4799-2984-9, Accession number: WOS: 000330939800241, 2013
61. Mirsu, D. B., Monitoring Help Desk Process Using KPI, SOFT COMPUTING APPLICATIONS, 2013
62. Mocofan, M.; Vasii, R., A 3D approach to Co-occurrence Matrix Features used in Dynamic Textures Indexing, INTERDISCIPLINARY RESEARCH IN ENGINEERING: STEPS TOWARDS BREAKTHROUGH INNOVATION FOR SUSTAINABLE DEVELOPMENT, 2013
63. Molnar-Matei, F., Voltage Dip Detection in noisy Environments using Tracking Filters, INTERDISCIPLINARY RESEARCH IN ENGINEERING: STEPS TOWARDS BREAKTHROUGH INNOVATION FOR SUSTAINABLE DEVELOPMENT, 2013
64. Muntean, S.; Ciocan, T.; Susan-Resiga, R. F.; Cervantes, M.; Nilsson, H., Mathematical, numerical and experimental analysis of the swirling flow at a Kaplan runner outlet, 26TH IAHR SYMPOSIUM ON HYDRAULIC MACHINERY AND SYSTEMS, PTS 1-7, 2013
65. Musuroi, S.; Sorandaru, C.; Greconici, M.; Olarescu, V. N.; Weinman, M., Low-Cost Ferrite Permanent Magnet Assisted Synchronous Reluctance Rotor an Alternative Solution for Rare Earth Permanent Magnet Synchronous Motors, 39TH ANNUAL CONFERENCE OF THE IEEE INDUSTRIAL ELECTRONICS SOCIETY (IECON 2013), 2013
66. Olariu, C.; Canda, A.; Draghici, A.; Rozman, T., Planning Business Process Management Implementation by a Human Resources Development Support Initiative, SOFT COMPUTING APPLICATIONS, 2013
67. Osaci, M.; Berdie, A. D.; Hammes, A. D., Studies on Efficiency of the Data Access by ABAP Programming, SOFT COMPUTING APPLICATIONS, 2013
68. Panoiu, M.; Panoiu, C.; Ghiormez, L., Modeling of the Electric Arc Behavior of the Electric Arc Furnace, SOFT COMPUTING APPLICATIONS, 2013
69. Papazian, P.; Babaita, M., Fieldbus Modeling using DOE with D-Optimal Analysis, 36th International Conference on Telecommunications and Signal Processing (TSP), JUL 02-04, 2013, Rome, Italy, IEEE, NEW YORK, 978-1-4799-0402-0; 978-1-4799-0403-7, 2013
70. Papazian, P.; Babaita, M., Fieldbus Performance Prediction using DOE with D-Optimal Analysis, 36th International Conference on Telecommunications and Signal Processing (TSP), JUL 02-04, 2013, Rome, Italy, IEEE, NEW YORK, 978-1-4799-0402-0; 978-1-4799-0403-7, 2013
71. Pater, F.; Lemle, L. D., On some Multiplication Operator Algebra Problem with Application to Stochastic Signal Models, 11TH INTERNATIONAL CONFERENCE OF NUMERICAL ANALYSIS AND APPLIED MATHEMATICS 2013, PTS 1 AND 2 (ICNAAM 2013), 2013

73. Paulescu, M.; Stefu, N.; Gravila, P.; Paulescu, E.; Pop, N.; Calinoiu, D.; Boata, R.; Pacurar, A.; Mares, O., Atmospheric Transmittance Model for Photosynthetically Active Radiation, TIM 2012 PHYSICS CONFERENCE, 2013
74. Perescu, A.; Bereteu, L., Simulation and Comparison of Quarter-Car Passive Suspension System with Bingham and Bouc-Wen MR Semi-Active Suspension Models, TIM 2012 PHYSICS CONFERENCE, 2013
75. Pop, O.; Surianu, F.; Kilyeni, S.; Barbulescu, C., Probabilistic Network Usage. Case Study for the Romanian Power System, Proceedings of the 48th International Universities' Power Engineering Conference (UPEC), September 2-5, 2013, Dublin, Ireland, pp. 1-6, ISBN 978-1-4799-3254-2, 2013
76. Popa, S.; Prostean, G., The Efficiency in Time and Financial Resources Management of an Individual by Developing an Informatics Support, SOFT COMPUTING APPLICATIONS, 2013
77. Pop-Calimanu, M.; Cojocaru, R.; Ciucă, C.; Fleser, T.; Petronela-Lucia Ciorpac. Welding of AA2124/SiC/25p-T4 by FSW at high welding speed and monitoring the process by real-time control of infrared termography and energy consumption, The 5th International Conference on Advanced Materials and Structures - AMS'13 Octombrie 2013, Timisoara, Romania (Solid State Phenomena, Trans Tech Publications), 2013
78. Pop-Calimanu, M.; Gubencu, D.; Pop-Calimanu, I.; Fleser, T., Optimization of ultrasonic welding parameters and temperature distribution in metal matrix composite based on aluminium, The 22nd International Conference on Metallurgy and Materials METAL 2013, Brno, Cehia, ISBN 978-80-87294-39-0, 1st edition, 2013
79. Popescu, M.; Ungureanu-Anghel, D.; Filip, I., Designing Complex Petri Nets using Submodels with Application in Flexible Manufacturing Systems, 2013 IEEE 8TH INTERNATIONAL SYMPOSIUM ON APPLIED COMPUTATIONAL INTELLIGENCE AND INFORMATICS (SACI 2013), 2013
80. Popov, D.; Pop, N.; Simon, S., The New Integrals in the Complex Plane Resulting from the Coherent State Formalism, Conference: 12th TIM Physics Conference of the West-University-of-Timisoara, TIM 2012 PHYSICS CONFERENCE, Book Series: AIP Conference Proceedings Volume: 1564, Pages: 3-9, 2013
81. Precup, R. E.; Radac, M. B.; Petriu, E. M.; Dragos, C. A.; Preitl, S.; Stinean, A. I., Data-Driven Performance Improvement of Control Systems for Three-Tank Systems, 2013 6TH INTERNATIONAL CONFERENCE ON HUMAN SYSTEM INTERACTIONS (HSI), 2013
82. Prostean, G.; Mirsu, D. B.; Draghici, A., Incidents Management Process Improvement of IT Systems, SOFT COMPUTING APPLICATIONS, 2013
83. Purcaru, C.; Precup, R. E.; Iercan, D.; Fedorovici, L. O.; David, R. C., Hybrid PSO-GSA Robot Path Planning Algorithm in Static Environments with Danger Zones, 2013 17TH INTERNATIONAL CONFERENCE ON SYSTEM THEORY, CONTROL AND COMPUTING (ICSTCC), 2013
84. Purcaru, C.; Precup, R. E.; Iercan, D.; Fedorovici, L. O.; Dohangie, B.; Dragan, F., nRobotic Mobile Robot Navigation Using Traffic Signs in Unknown Indoor Environments, 2013 IEEE 8TH INTERNATIONAL SYMPOSIUM ON APPLIED COMPUTATIONAL INTELLIGENCE AND INFORMATICS (SACI 2013), 2013
85. Radac, M. B.; Achimescu, R. A.; Precup, R. E.; Preitl, S.; Dragos, C. A.; Stinean, A. I., Design and Experiments for Model-Free PI Control of DC Drives, 2013 IEEE 8TH INTERNATIONAL SYMPOSIUM ON APPLIED COMPUTATIONAL INTELLIGENCE AND INFORMATICS (SACI 2013), 2013
86. Radac, M. B.; Precup, R. E.; Preitl, S.; Dragos, C. A.; Petriu, E. M., Constrained Data-Driven Controller Tuning for Nonlinear Systems, 39TH ANNUAL CONFERENCE OF THE IEEE INDUSTRIAL ELECTRONICS SOCIETY (IECON 2013), 2013
87. Radu, R.; Micu, D.; Ceclan, A.; Barbulescu, C.; Kilyeni, S., Recent advances on the influence of power transformers inrush current over the optimization of medium voltage feeder protection, Proceedings of the 48th International Universities' Power Engineering Conference (UPEC), September 2-5, 2013, Dublin, Ireland, pp. 1-6, ISBN 978-1-4799-3254-2, 2013
88. Sasu, E. C., Mathematical Model and Formalization for DTF Method, SOFT COMPUTING APPLICATIONS, 2013
89. Sasu, E. C.; Prostean, O., Using Fuzzy Logic to Determine If the Traffic Is Constant or Not in DTF Method, SOFT COMPUTING APPLICATIONS, 2013



91. Solomonesc, F.; Barbulescu, C.; Kilyeni, S.; Litcanu, M.; Genetic algorithms. Power systems applications, Proceedings of the 6th International Conference on Human System Interactions (HSI), June 6-8, 2013, Gdansk, Poland, pp. 407-414, ISBN 978-146735637-4, 2013
92. Solomonesc, F.; Barbulescu, C.; Kilyeni, S.; Pop, O.; Cristian, D., Artificial intelligence based TNEP. Part 2: Case studies, Proceedings of the 8th IEEE International Symposium on Applied Computational Intelligence and Informatics (SACI), May 23-25, 2013, Timisoara, Romania, pp. 395-398, ISBN 978-146736400-3, 2013
93. Solomonesc, F.; Barbulescu, C.; Kilyeni, S.; Simo, A., Optimal Power Flow Computing GA Applications, Proceedings of the 48th International Universities' Power Engineering Conference (UPEC), September 2-5, 2013, Dublin, Ireland, pp. 1-6, ISBN 978-1-4799-3254-2, 2013
94. Sorandaru, C.; Babescu, M.; Musuroi, S., Load control method for photovoltaic solar panels based on the measurement of short circuit currents, 2013 17TH INTERNATIONAL CONFERENCE ON SYSTEM THEORY, CONTROL AND COMPUTING (ICSTCC), 2013
95. Stefan, O.; Codrean, A.; Dragomir, T. L., A Network Control Structure with a Switched PD Delay Compensator and a Nonlinear Network Model, 2013 AMERICAN CONTROL CONFERENCE (ACC), 2013
96. Stinean, A. I.; Preitl, S.; Precup, R. E.; Dragos, C. A.; Petriu, E. M.; Radac, M. B., 2-DOF Control Solutions for an Electric Drive System under Continuously Variable Conditions, 2013 IEEE 8TH INTERNATIONAL SYMPOSIUM ON APPLIED COMPUTATIONAL INTELLIGENCE AND INFORMATICS (SACI 2013), 2013
97. Stoica, D.; Megan, M.; Lemle, D. L., Polynomial Stability in Mean Square of Stochastic Cocycles in Hilbert Spaces, 11TH INTERNATIONAL CONFERENCE OF NUMERICAL ANALYSIS AND APPLIED MATHEMATICS 2013, PTS 1 AND 2 (ICNAAM 2013), 2013
98. Stolojescu-Crisan, C.; Isar, A., Two Approaches for the Estimation of the Heaviness of Traffic in Wireless Networks, 36th International Conference on Telecommunications and Signal Processing (TSP), JUL 02-04, 2013, Rome, Italy, IEEE, NEW YORK, 978-1-4799-0402-0; 978-1-4799-0403-7, 2013
99. Strugariu, L.; Crisan, E.; Socalici, V.; Heput, T., Mathematical Modeling based on Qualitative Characteristics of Briquettes Depending on the Composition of Recipes, 11TH INTERNATIONAL CONFERENCE OF NUMERICAL ANALYSIS AND APPLIED MATHEMATICS 2013, PTS 1 AND 2 (ICNAAM 2013), 2013
100. Suci, O.; Bereteu, L.; Draganescu, G., Determination of Mechanical Properties of Hydroxyapatite Doped with Magnesium, TIM 2012 PHYSICS CONFERENCE, 2013
101. Susan-Resiga, R.; Muntean, S.; Ciocan, T.; Joubarne, E.; Leroy, P.; Bornard, L., Influence of the velocity field at the inlet of a Francis turbine draft tube on performance over an operating range, 26TH IAHR SYMPOSIUM ON HYDRAULIC MACHINERY AND SYSTEMS, PTS 1-7, 2013
102. Szabo, R.; Gontean, A., Creating a Programming Language for the AL5 Type Robotic Arms, 36th International Conference on Telecommunications and Signal Processing (TSP), JUL 02-04, 2013, Rome, Italy, IEEE, NEW YORK, 978-1-4799-0402-0; 978-1-4799-0403-7, 2013
103. Tamasila, M.; Taucean, I. M., The Comparative Analysis of the Innovation Level for the Entrepreneurial Education, SOFT COMPUTING APPLICATIONS, 2013
104. Tanasa, C.; Bosioc, A. I.; Susan-Resiga, R. F.; Muntean, S., Experimental investigations of the swirling flow in the conical diffuser using flow-feedback control technique with additional energy source, 26TH IAHR SYMPOSIUM ON HYDRAULIC MACHINERY AND SYSTEMS, PTS 1-7, 2013
105. Tatai, I.; Greconici, M., Optimization of the Power Transfer Control between the Ports of a Double Bridge DC-DC Power Converter Type Gyrator, SOFT COMPUTING APPLICATIONS, 2013
106. Thalmaier, G.; Vida-Simiti, I.; Vermesan, H.; Codrean, C.; Chira, M., Corrosion Resistance Measurements of Amorphous Ni<sub>40</sub>Ti<sub>40</sub>Nb<sub>20</sub> Bipolar Plate Material for Polymer Electrolyte Membrane Fuel Cells, INTERDISCIPLINARY RESEARCH IN ENGINEERING: STEPS TOWARDS BREAKTHROUGH INNOVATION FOR SUSTAINABLE DEVELOPMENT, 2013
107. Topirceanu, A.; Udrescu, M.; Vladutiu, M., Network Fidelity: A Metric to Quantify the Similarity and Realism of Complex Networks, 2013 IEEE THIRD INTERNATIONAL CONFERENCE ON CLOUD AND GREEN COMPUTING (CGC 2013), 2013

# Books



1. Belega, Daniel, Măsurări electrice și electronice : culegere de probleme, Editura Politehnica, Timișoara, 2013, ISBN 9786065546721;
2. Berian, Dorin, Programare în Visual Basic .NET : aplicații practice, Editura Politehnica, Timișoara, 2013, ISBN 9786065546349;
3. Bordeasu, I; Galeriu, CD; Sucitu, L; Dobanda, E; Baciu, ID; Badarau, R; Velescu, C; Manea, AS; Florescu, C, Probleme de hidrodinamică, rețele de conducte, canale și mașini hidraulice, Editura Politehnica, Timișoara, 2013, ISBN 9786065546165;
4. Buta, Adrian, Transportul și distribuția energiei electrice, Editura Politehnica, Timișoara, 2013, ISBN 9786065545809;
5. Cernicova, Mariana; Dragomir, Mugur; Țîru, Gabriel, Imaginea universității românești în secolul XXI și vectorii săi, Tritonic, București, 2013, ISBN 978-606-8571-05-8;
6. Ciopec, A; Mirea, M; Roman, L; Roman, OC, Aide-mémoire român – englez pentru termeni de geologie inginerească : = Aide-mémoire Roman, Editura Politehnica, Timișoara, 2013, ISBN 9786065546592;
7. Ciopec, A; Mirea, M; Roman, L; Roman, OC, Glosar român-german pentru termeni de geologie inginerească : = Rumänisch deutsches Glossar für ingenieurgeologie Begriffe, Editura Politehnica, Timișoara, 2013, ISBN 9786065547223;
8. Constantin, Elena Claudia, Mini technical dictionary: English-Romanian : Romanian-English = Mic dicționar tehnic: român- englez, Mirton, Timișoara, 2013, ISBN 9789735213756;
9. Costescu, Ioana Alina, Dicționar român- englez, englez-român cu termeni și expresii utilizate în domeniul protecției mediului, Editura Politehnica, Timișoara, 2013, ISBN 9786065547247;
10. Crișan, Andrei, Încercări de laborator pentru construcții metalice, Editura Politehnica, Timișoara, 2013, ISBN 9786065547278;
11. Dan, Daniel, Fizica construcțiilor : determinări experimentale și exemple de calcul , Editura Politehnica, Timișoara, 2013, ISBN 9786065546325;
12. Dan, Daniel, Fizica construcțiilor, Editura Politehnica, Timișoara, 2013, ISBN 9786065546059;
13. Gheju, Marius Traian, Chimia apelor naturale, Editura de Vest, Timișoara, 2013, ISBN 9789733605744;
14. Hlușcu, Mihai, Rezistența materialelor. [Vol. II], Mirton, Timișoara, 2013, ISBN 9789735213114 (Set);
15. Ionel, Ioana (Editor); Barna, Bodó; Kovács, Katalin; Bundău, Olivia; Popescu, Francisc; Makra, László; Csépe, Zoltán; Matyasovszky, István; Lontis, Nicolae Stelian; Vetres, Ion; Culture and Air quality, Editura Politehnica, Timișoara, 2013, ISBN 978-606-554-669-1;
16. Ionel, Ioana; Dungan, Luisa Izabel; PRACTICOR, Ghid de bune practici, Editura Politehnica Timișoara, 2013, ISBN 978-606-554-705-9;
17. Irimia, Dumitru-Doru; Blaj, Constantin, Circuite electrice, Editura Politehnica, Timișoara, 2013, ISBN 9786065546752;
18. Jitian, Simion, Chimie generală, Editura Politehnica, Timișoara, 2013, ISBN 9786065546776;
19. Kellenberger, Andrea, Electrochimia stării solide, Editura Politehnica, Timișoara, 2013, ISBN 9786065545632
20. Kilyeni, Annamaria, Discourse and Femininity in Print Ads. The Rhetorical Presence of the Body in the Language of Contemporary Advertising, Ed. Orizonturi Universitare, Timișoara, 2013, ISBN 978-973-638-549-0; Casa Cărții de Știință, Cluj-Napoca, ISBN 978-606-17-0502-3;
21. Lazău, Radu-Ioan, Materiale multifuncționale inteligente, Editura Politehnica, Timișoara, 2013, ISBN 9786065546189
22. Luminosu, Caius Tudor, Drept constituțional și drept administrativ : culegere de texte, Editura Politehnica, Timișoara, 2013, ISBN 9786065546462
23. Medeleanu, Mihai, Modelarea nanostructurilor, Editura Politehnica, Timișoara, 2013, ISBN 9786065546134
24. Moldovan, Cristian Emil, Mecatronică : aplicații cu baze de date, Editura Politehnica, Timișoara, 2013, ISBN 9786065546332
25. Negrea, Adina, Protecția mediului, Editura Politehnica, Timișoara, 2013, ISBN 9786065546974
26. Negrea, Romeo Iosif, Matematică și management, Editura Politehnica, Timișoara, 2013, ISBN 9786065547209

28. Pop, Mirela-Cristina, La traduction : aspects théoriques, pratiques et didactiques: domaine français-roumain, Orizonturi Universitare, Timișoara, 2013, ISBN 9789736385285
29. Pop, Mirela-Cristina, Paraphrase et traduction des modalités : les axiologiques : domaine français-roumain, Orizonturi Universitare Casa Cărții de Știință, Timișoara/Cluj-Napoca, 2013, ISBN 9789736385049/9786061703777
30. Popa, Mihaela, Sportul universitar : abordare contextuală, Editura Politehnica, Timișoara, 2013, ISBN 9786065546493
31. Rațiu, Sorin, Motoare cu ardere internă pentru autovehicule rutiere : construcție și calcul : demers practic, Editura Politehnica, Timișoara, 2013, ISBN 9786065546172
32. Sârbu, Ioan, Confortul ambiental, Editura Politehnica, Timișoara, 2013, ISBN 9786065547292
33. Sava, Marcela, Mașini de ridicat și transportat, Eurostampa, Timișoara, 2013, ISBN 9786065696549
34. Silaghi-Perju, Dana, Fundamente de inginerie mecanică : teorie și aplicații, Editura Politehnica, Timișoara, 2013, ISBN 9786065547063
35. Tatai, Ildikó, Circuite electrice : probleme, Editura Politehnica, Timișoara, 2013, ISBN 9786065546790
36. Țigan, Gheorghe, Differential and integral calculus, Editura Politehnica, Timișoara, 2013, ISBN 9786065546516
37. Țigan, Gheorghe, Introduction to differential equations and dynamical systems, Editura Politehnica, Timișoara, 2013, ISBN 9786065546141
38. Tirian, Gelu Ovidiu, Robotică, Editura Politehnica, Timișoara, 2013, ISBN 9786065545960
39. Udrescu, Mihai, Emerging computing systems : quantum computing from a computer engineering perspective, Editura Politehnica, Timișoara, 2013, ISBN 9786065546844
40. Vintila, Teodor (Editor); Kovacs, Kornel; Bagi, Zoltan; Ionel, Ioana; Cioabla, Adrian Eugen; Neo, Simona; Biofuels and renewable resources, Editura Mirton, Timișoara, 2013, ISBN 978-973-52-1402-9
41. Zaharie, Ioan, Elemente de fizica stării solide. Fenomene și aplicații, Editura Politehnica, Timișoara, 2013, ISBN 978-606-554-716-2



# Politehnica University of Timisoara



Piata Victoriei No. 2  
RO 300006, Timisoara  
Tel: +40 256 40 30 00  
Fax: +40 256 40 30 21  
Email: [rector@upt.ro](mailto:rector@upt.ro)  
[www.upt.ro](http://www.upt.ro)



EDITURA POLITEHNICA

ISSN 1841-2769